

☰ Command girişi: ray ↵,

Multiline (Çoklu çizgi)

- ☞ Modify Kayar menü: Multiline
- ☞ Modify toolbar:
- ☰ Command girişi: mline ↵, mL ↵

Polyline (Birleşik çizgi)

- ☞ Modify Kayar menü:
Polyline Modify toolbar:



☰ Command girişi: pl ↵,

Specify start point: Specify a point (1)

Current line-width is <current>

Specify next point or [Arc/Close/Halfwidth/Length/Undo/Width]: Specify a point (2) or enter an option

Polygon (Çokgen)

- ☞ Modify Kayar menü:
Polygon Modify toolbar:



☰ Command girişi: pl ↵,

Enter number of sides <current>: Enter a value between 3 and 1024 or press ENTER

Specify center of polygon or [Edge]: Specify a point (1) or enter

ÖRNEKLER

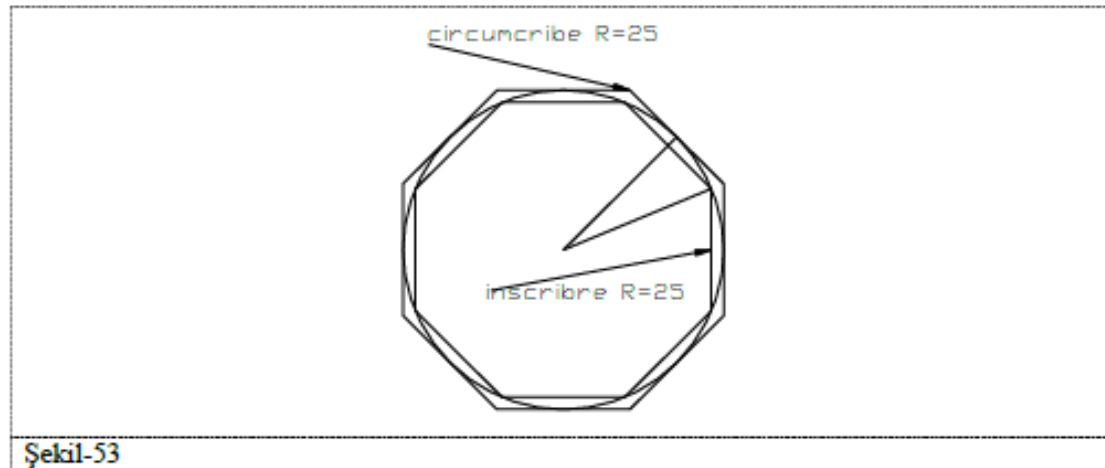

Şekil-53



Rectangle (Dörtgen)

 Modify Kayar menü:
Rectangle Modify toolbar:



 Command girişi: rec ↵,

Arc (Yay çizmek)

 Modify Kayar menü:
Arc Modify toolbar:



 Command girişi: arc↵,

Specify start point of arc or [Center]:Specify a point, enter c, or press ENTER t o start tangent to last line, arc, or polyline



Circle (Çember çizmek)

 Modify Kayar menü:
Çember Modify toolbar:



 Command girişi: circle↵, c↵

Donut (Dolu çember çizmek)

 Modify Kayar menü: donut
 Modify toolbar:
 Command girişi: donut↵,

Spline (esnek birleşik çizgi)

 Modify Kayar menü:
spline Modify toolbar:



 Command girişi: spline↵,

Elipse (Elips)

 Modify Kayar menü: elips



Modify toolbar: 
Command giriŝi: elipse., el.,

ÖRNEKLER

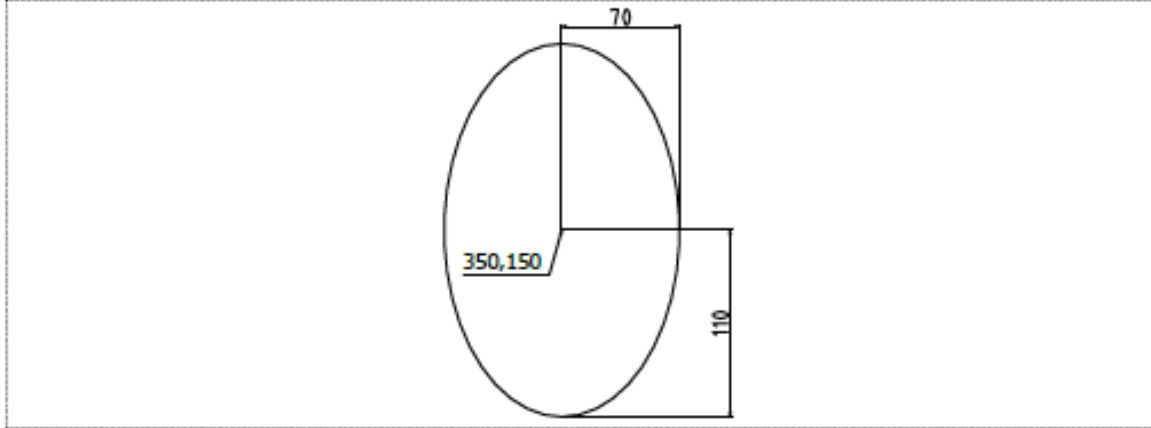

Ŗekil-54

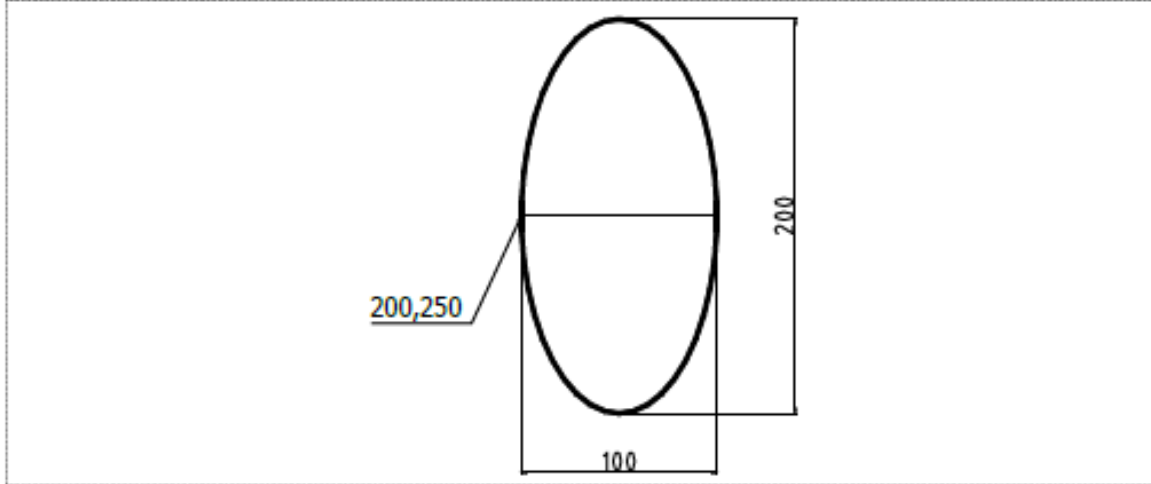

Ŗekil-55

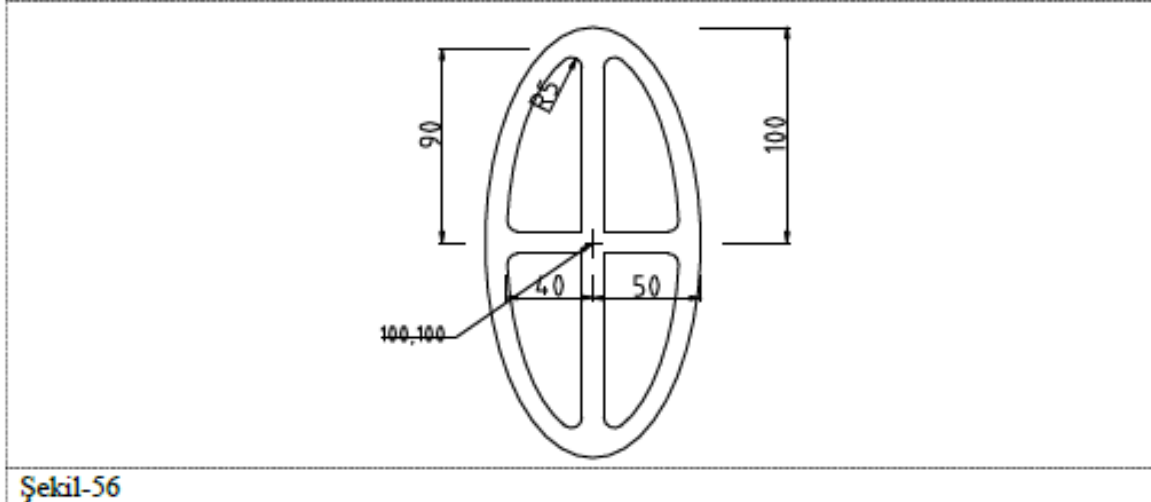



Ŗekil-56

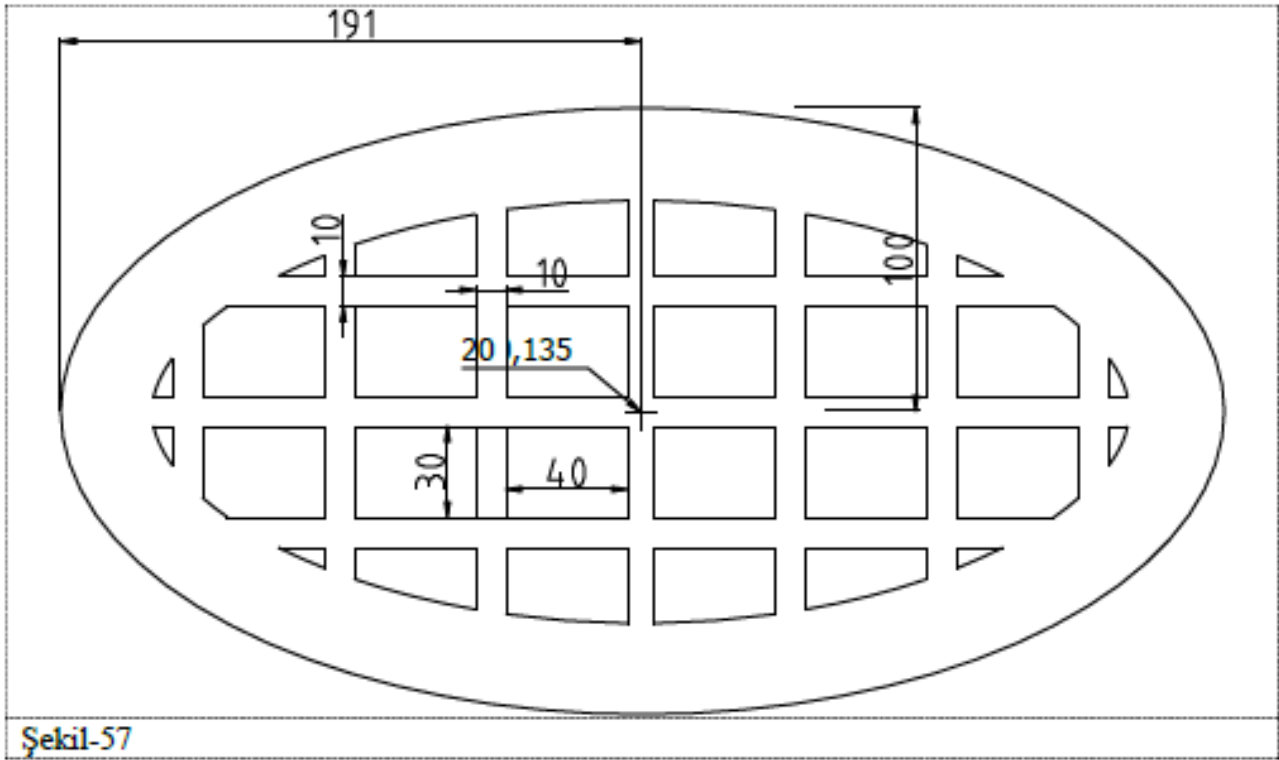



Block (Blok yap)



 Modify Kayar menü: block

 make Modify toolbar: 

 Command girışı: block ↵

Point (Nokta)



 Modify Kayar menü: Point Modify

 toolbar: 

 Command girışı: point ↵, po ↵

Hatch (Tarama)

 Modify Kayar menü: hatch Modify

 toolbar: 

 Command girışı: hatch ↵

