

POLİMER KOMPOZİTLERİ

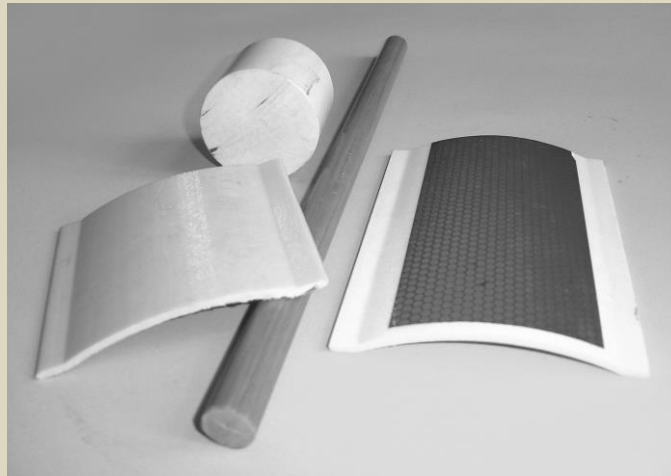

10.5.2 ELLE YATIRMA

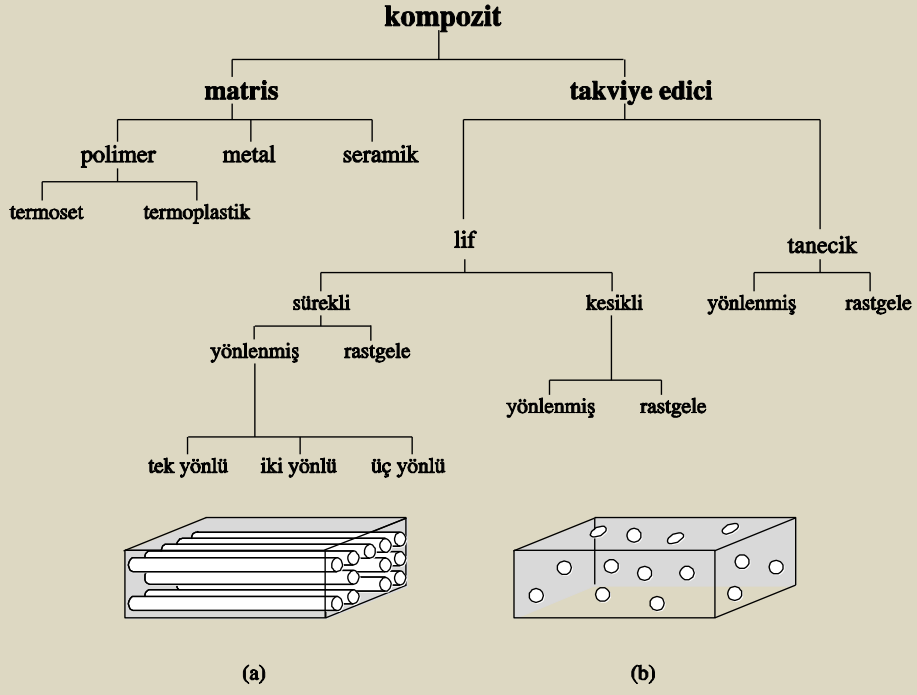
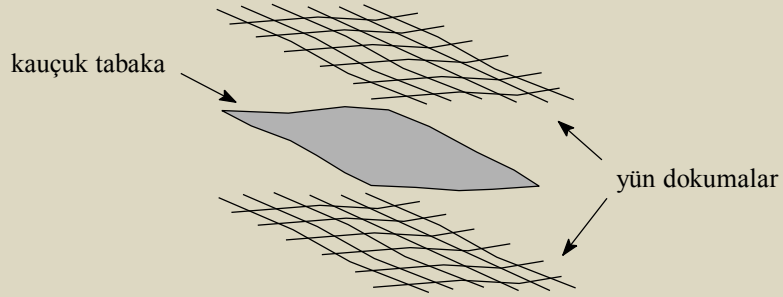
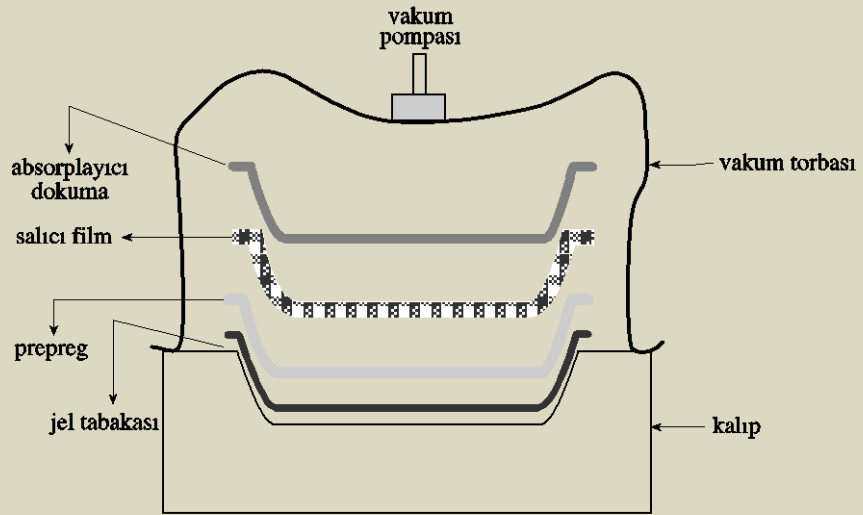
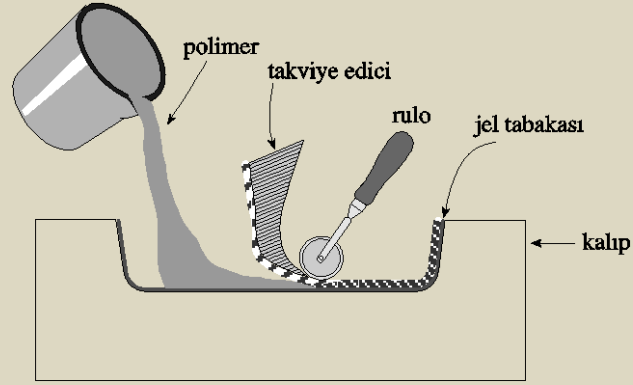

(a)

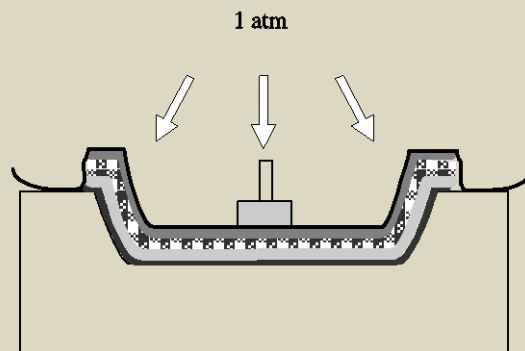

(b)

10.5.3 PÜSKÜRTME YÖNTEMİ

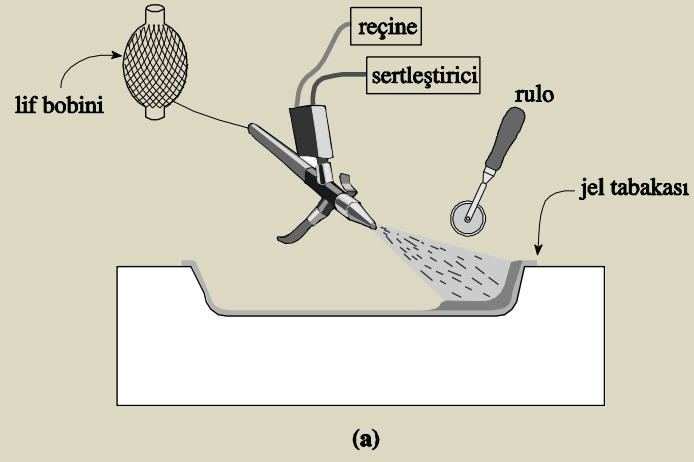

10.5.4 FİLAMENT SARMA

