



(KLA 301) HELLENİSTİK MİMARLIK

2020/2021

© Ankara Üniversitesi – Ders içeriklidir.
İzinsiz Yayınlanamaz – Kopyalanamaz

Doç. Dr. Görkem KÖKDEMİR

Ankara Üniversitesi

Dil ve Tarih-Coğrafya Fakültesi

Arkeoloji Bölümü, Klasik Arkeoloji Anabilim Dalı

(Öğretim Üyesi)

E-mail: gkokdemir@ankara.edu.tr



(KLA 301) HELLENİSTİK MİMARLIK



VIII. HAFTA – TAPINAKLAR 02 PSEUDODIPTEROS 02 - DIPTEROS

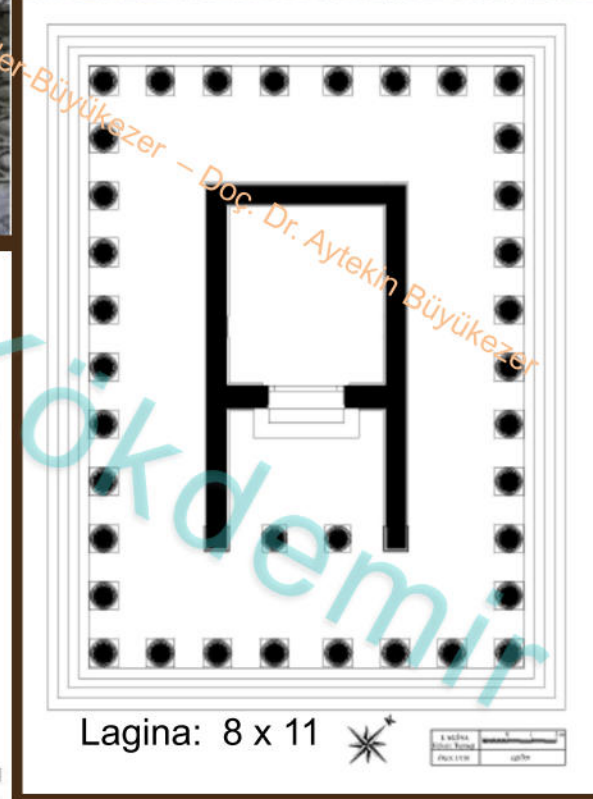
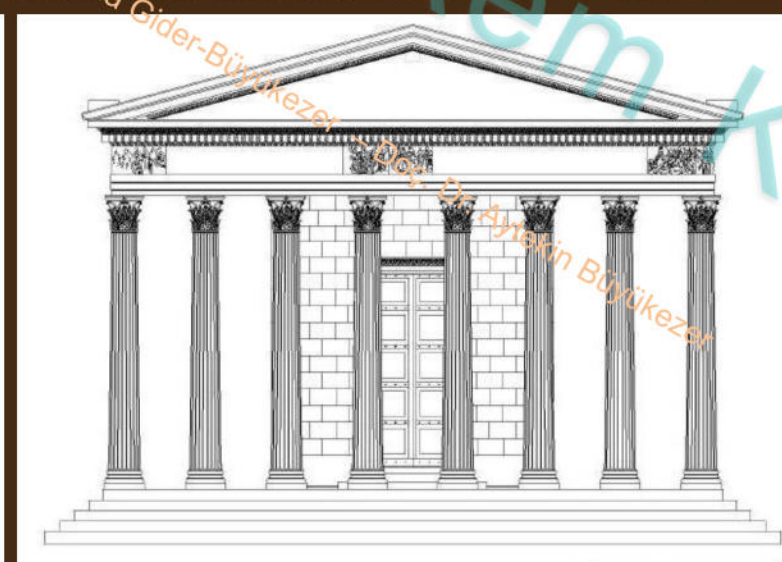
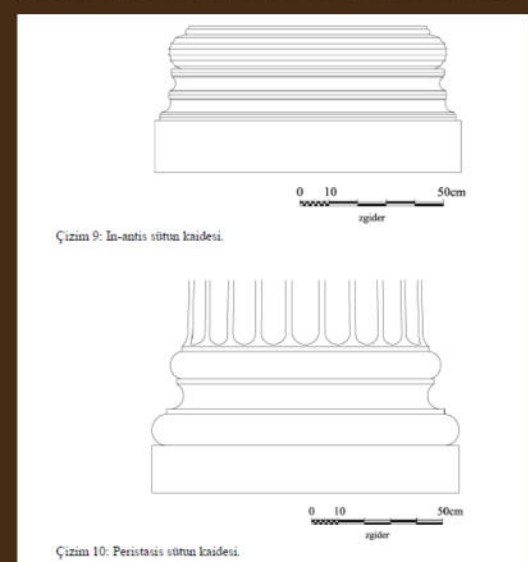

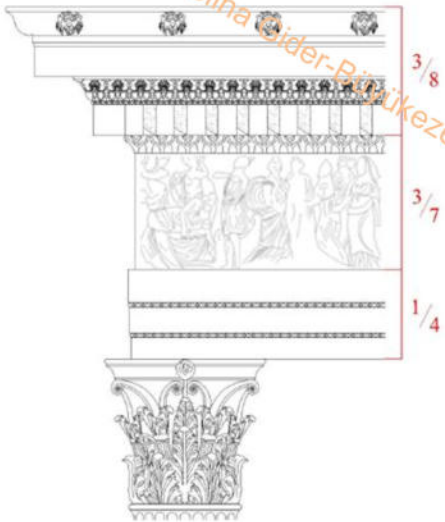
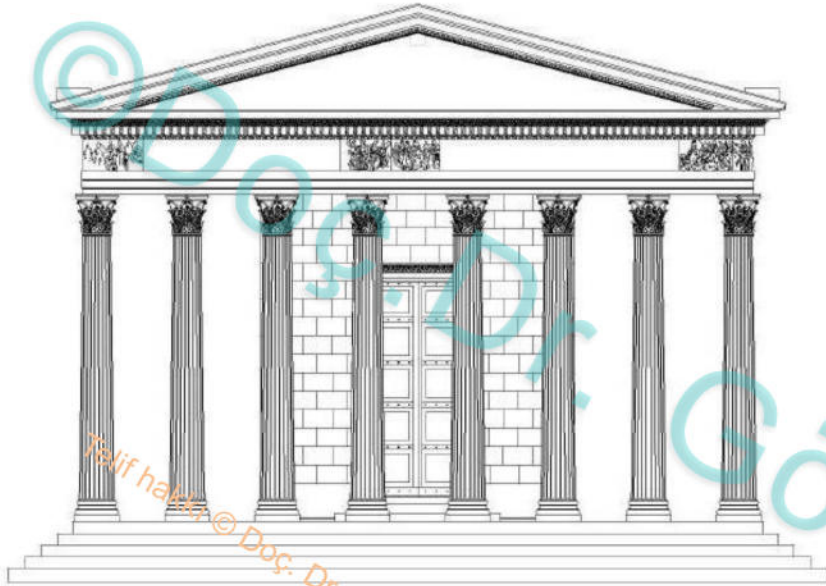



(KLA 301) HELLENİSTİK MİMARLIK



Magnesia – Artemis Tapınağı

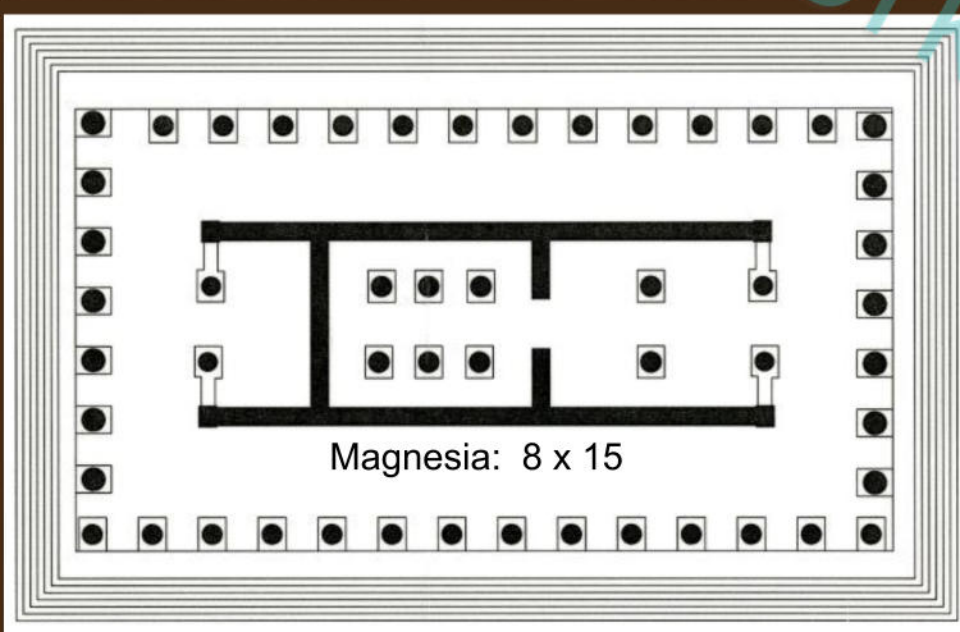

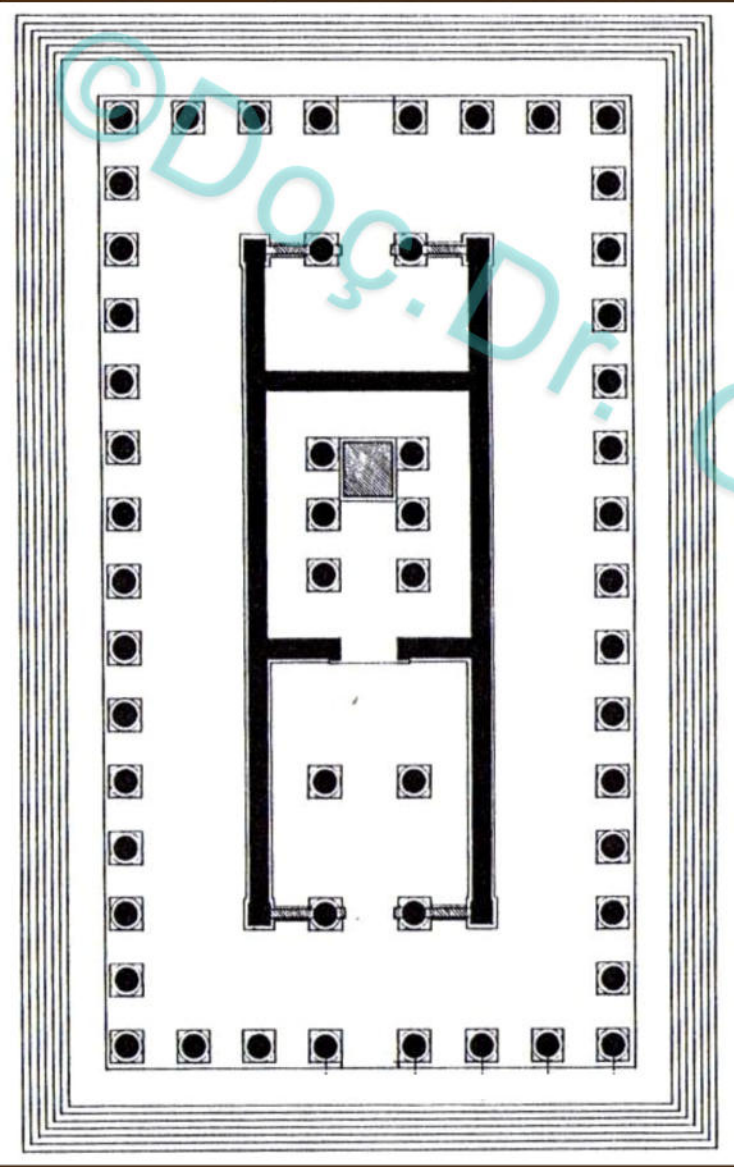

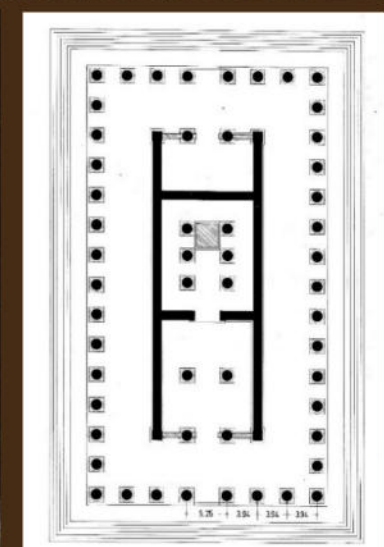
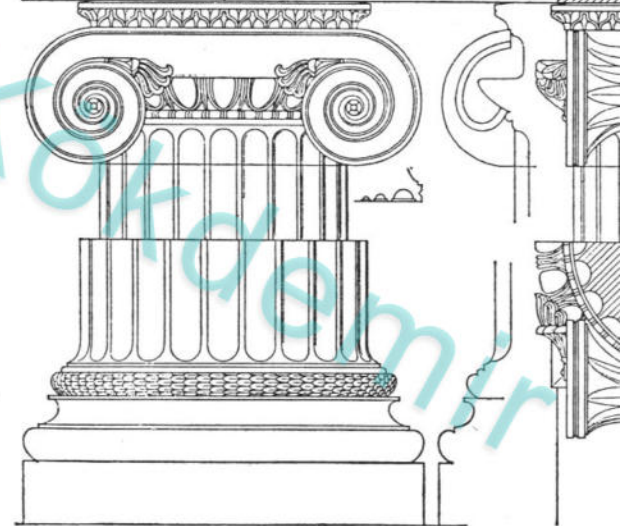
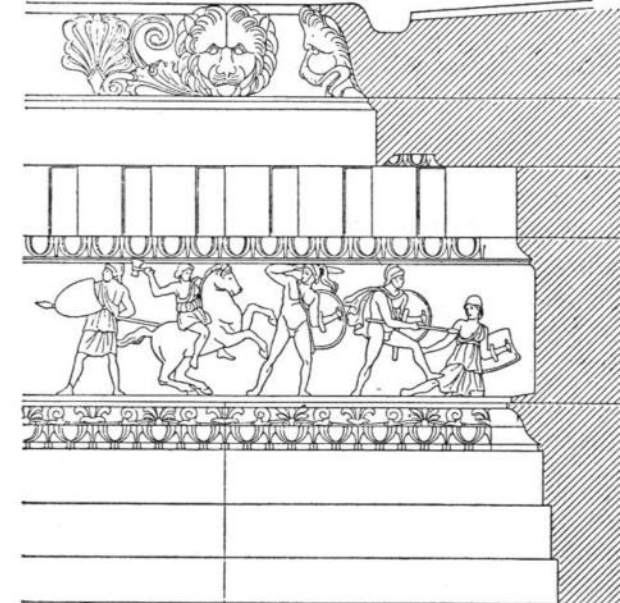
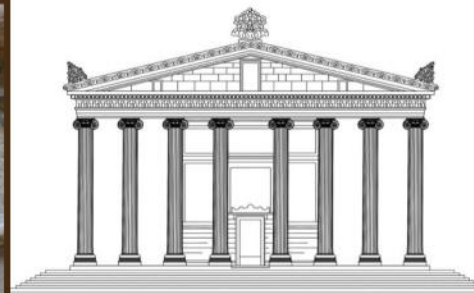



(KLA 301) HELLENİSTİK MİMARLIK



HELLENİSTİK DÖNEM ANADOLU DİPTEROS TAPINAKLAR CEPHE MİMARİSİ FRİZ (?)

DİDYMA APOLLON TAPINAĞI

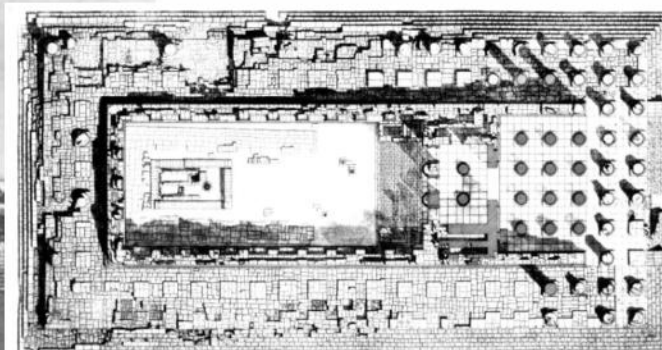
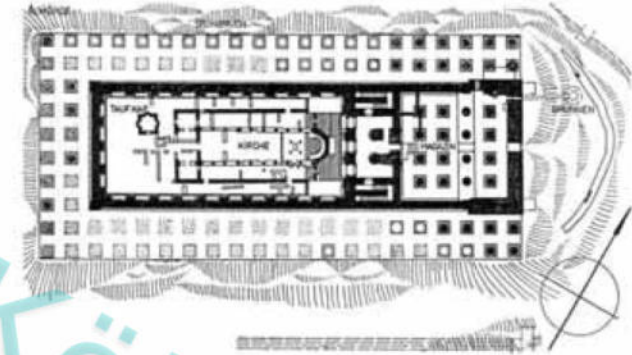
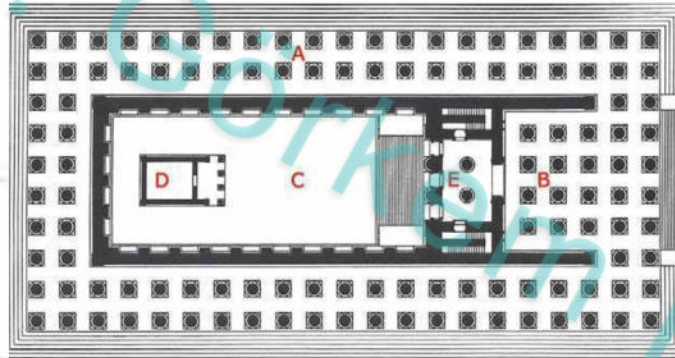
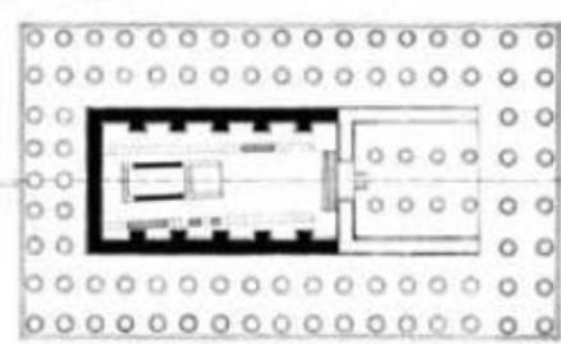
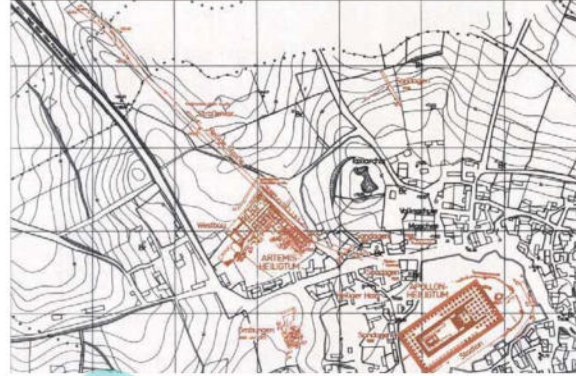
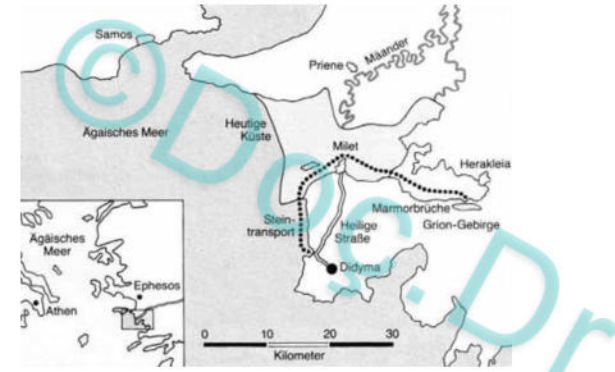

B. Khresmographeion



Abb. 63. Zwölf- und Zweisäulensaal (AW 1991).



Abb. 64. Das südliche Treppenhaus (JB).

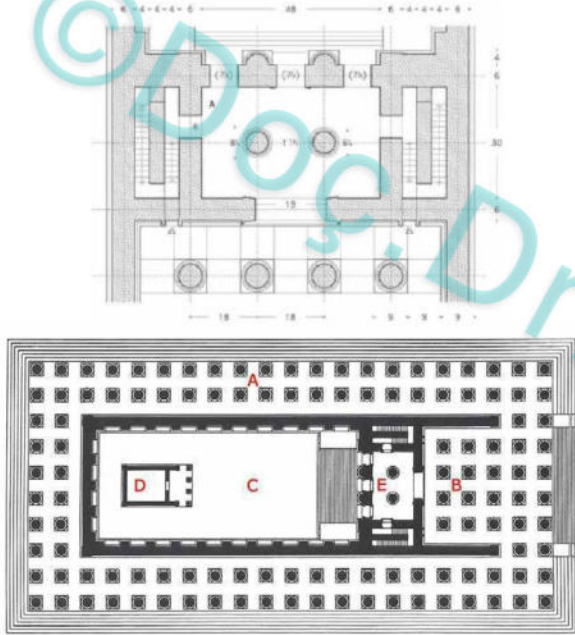

Abb. 57. Der nördliche Tunnel zum Adyton (AW 1991).



Abb. 20. Rekonstruierter Grundriss des Apollontempels (Knackfuss/JB).

- A. Ringhalle (Peristasis)
- B. Zwölf-säulensaal (Prodomos)
- C. Hof (Adyton)
- D. Naiskos
- E. Zweisäulensaal

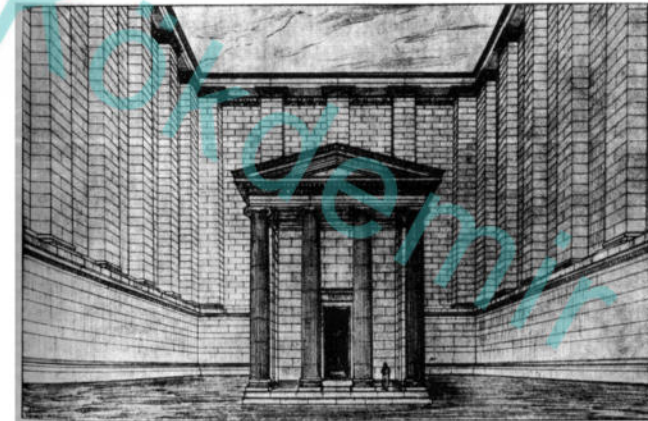

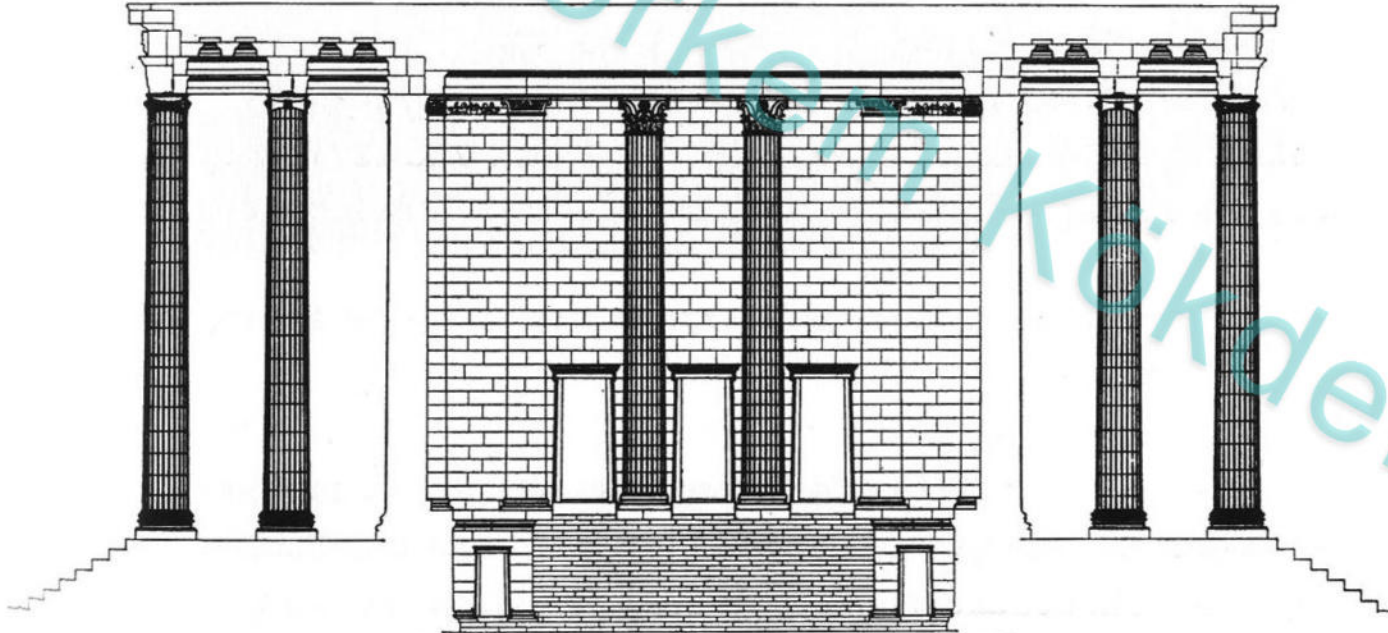
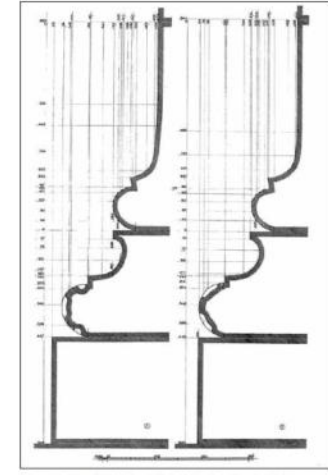
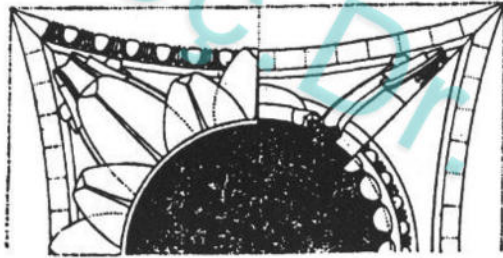



Abb. 122. Die Metakanthos der Plater in Aulis. Maßstab: in Fuß, Verhältnisse in rot (S)



Abb. 123. Die Metakanthos der Platergleitung in Grundis. Maßstab: in Fuß, Verhältnisse in rot (S)



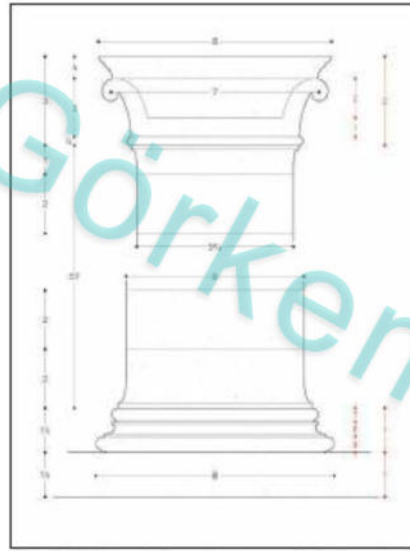
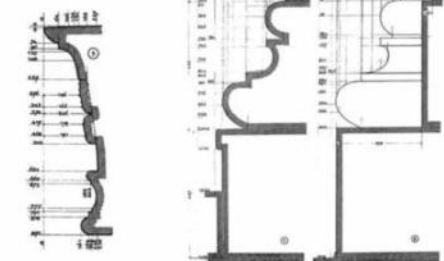
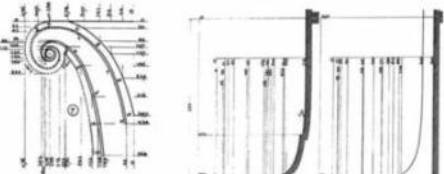
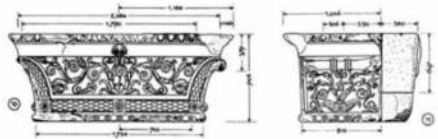
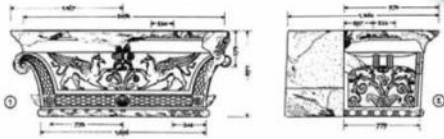
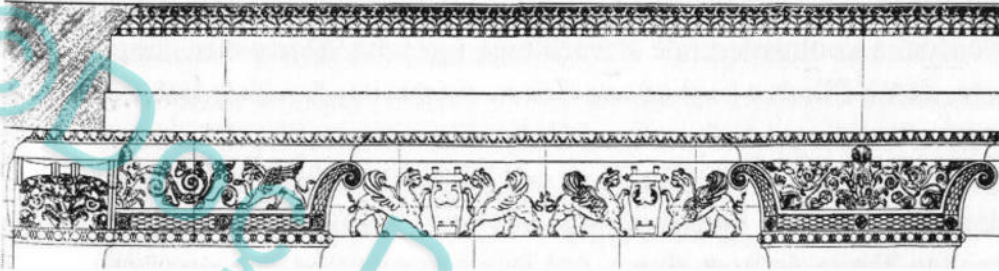

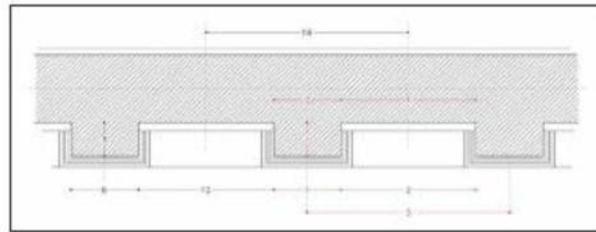
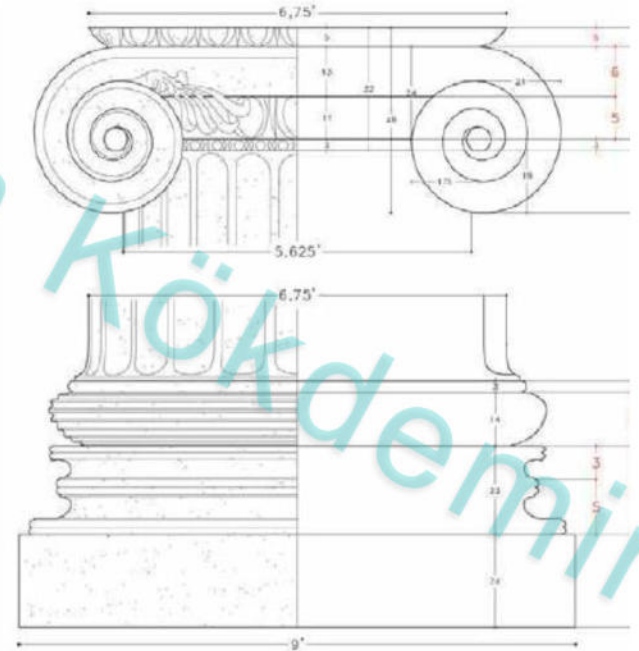
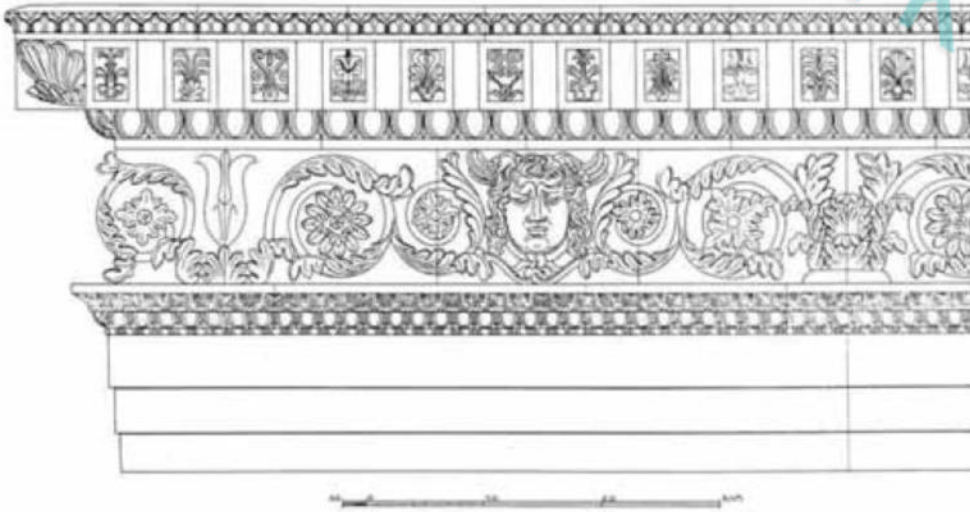
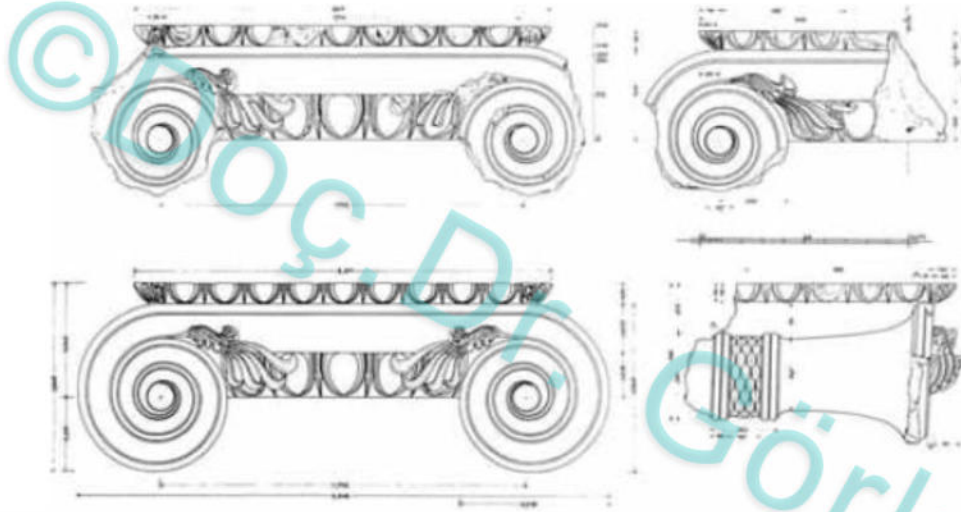

Abb. 2. Dekorsysteme der Frontsäulen

314) Ausführliche Beschreibung und Abbildungsnachweise s. Did. I 83 ff.



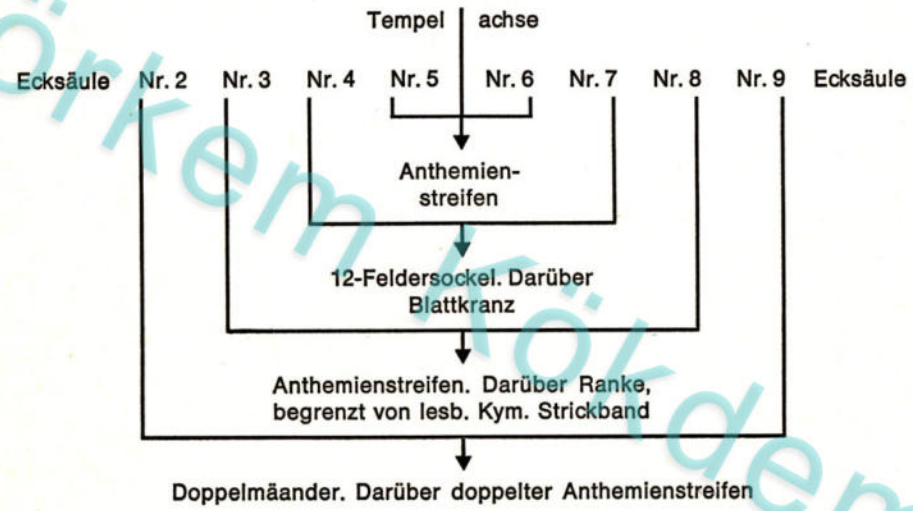
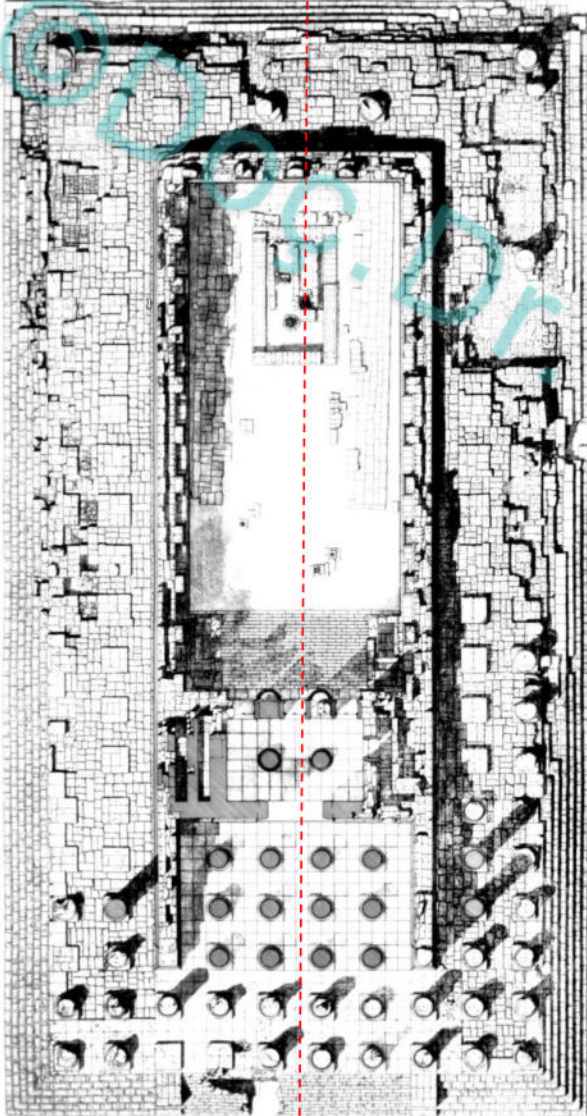
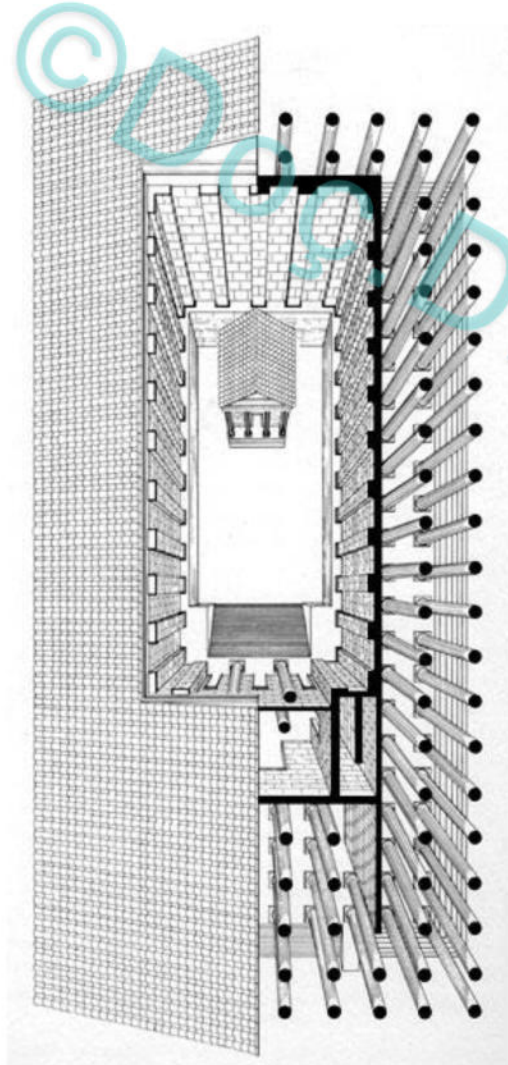

Abb. 2. Dekorsysteme der Frontsäulen

DİDYMA

APOLLON TAPINAĞI



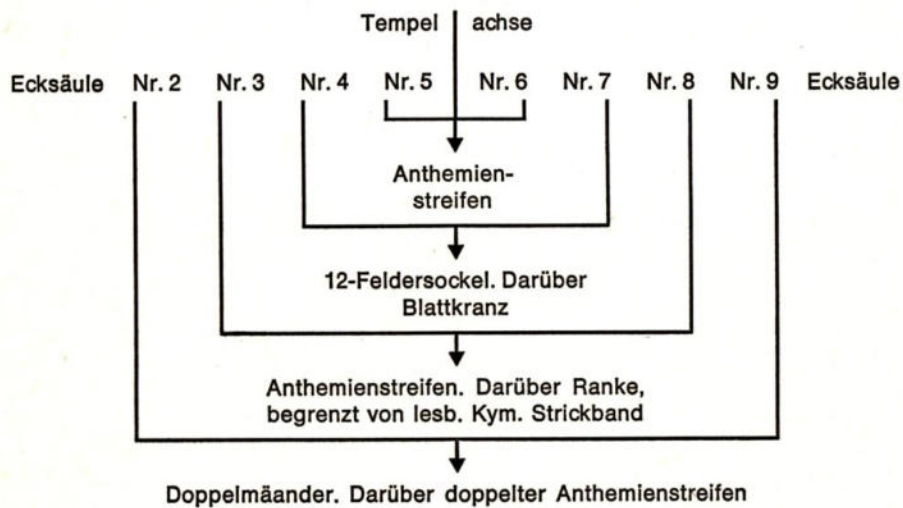
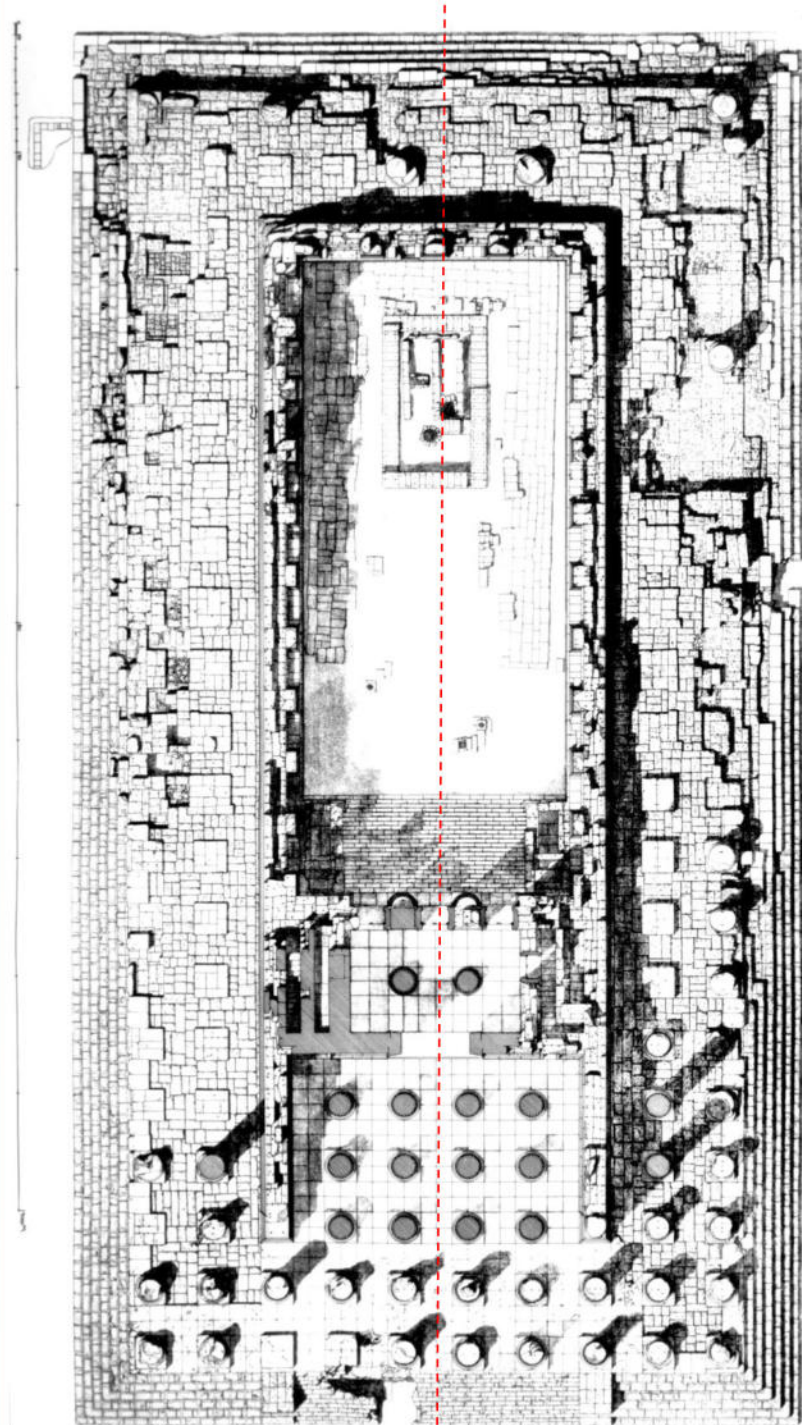
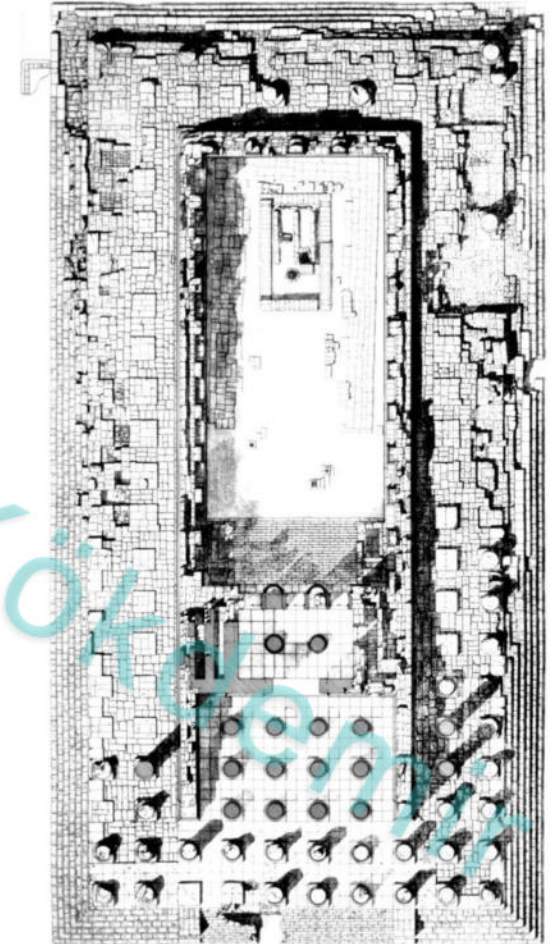
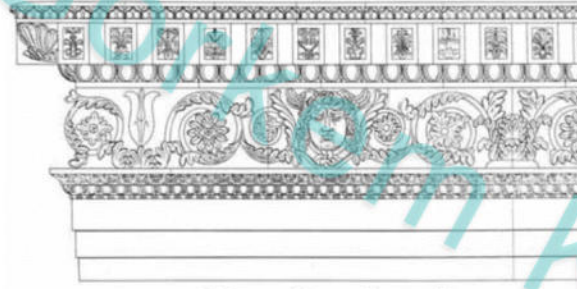

Ansicht des Fundaments von Nordwesten (JB).



(33 a)



Abb. 135. Ansicht des Naiskos, Rekonstruktion von H. Knackfuss (Z. 597).







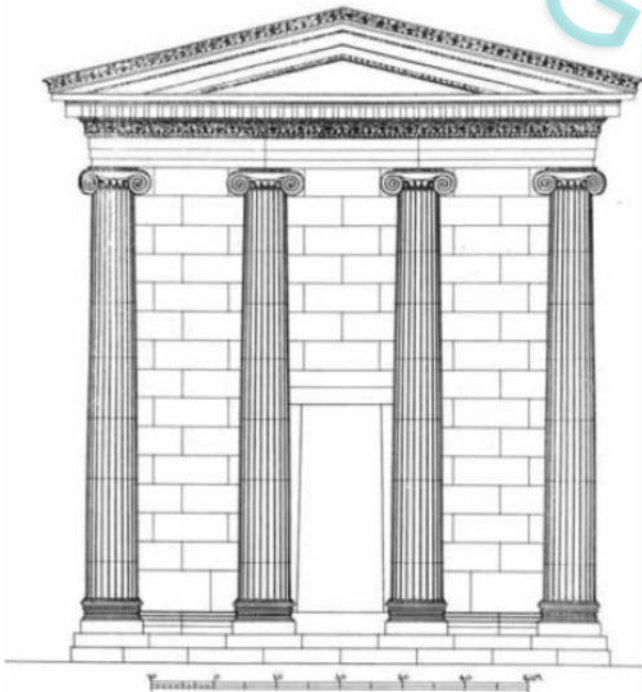
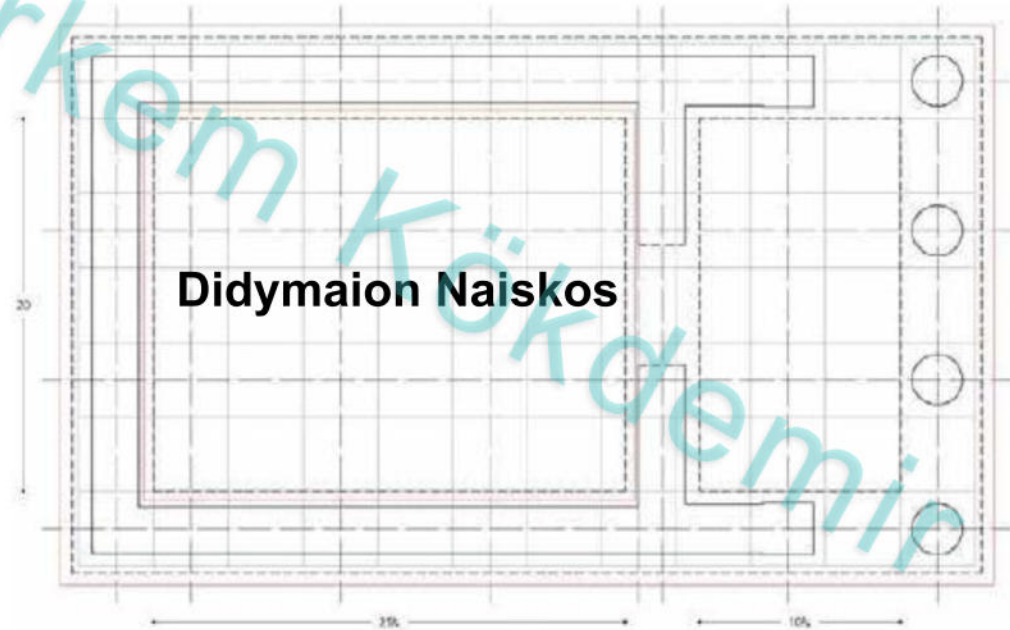
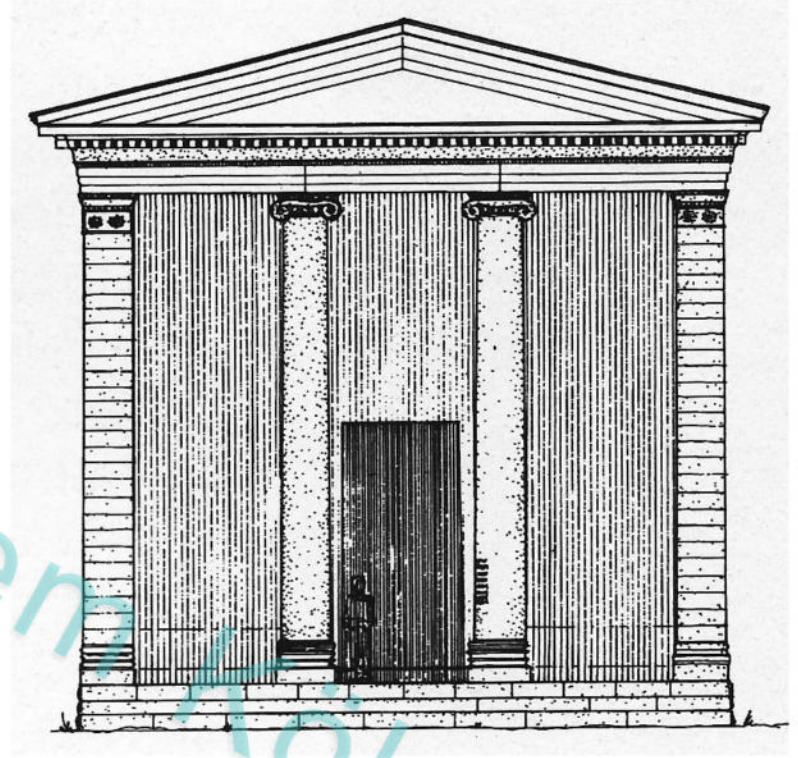
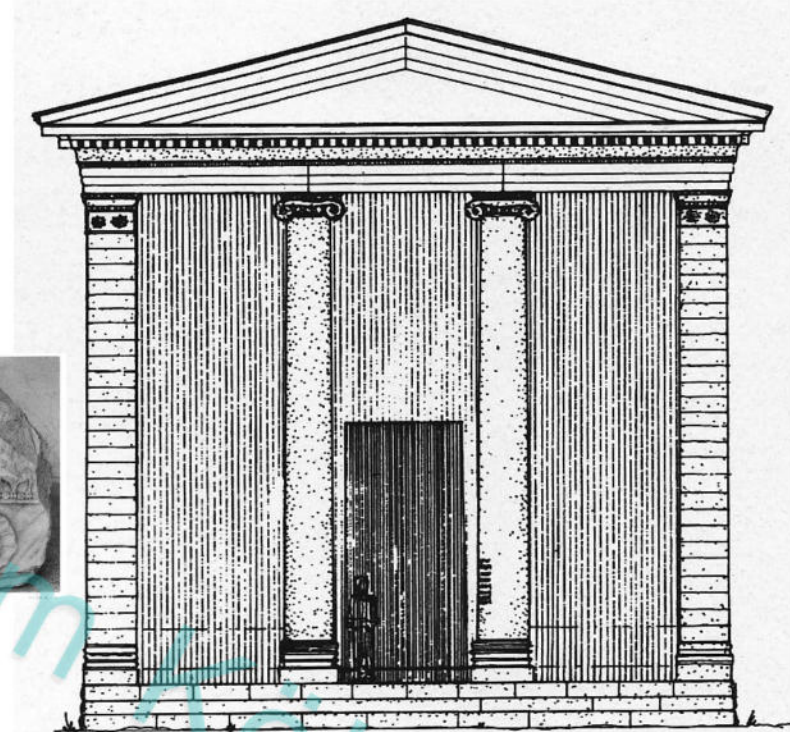
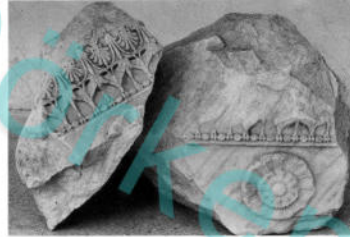
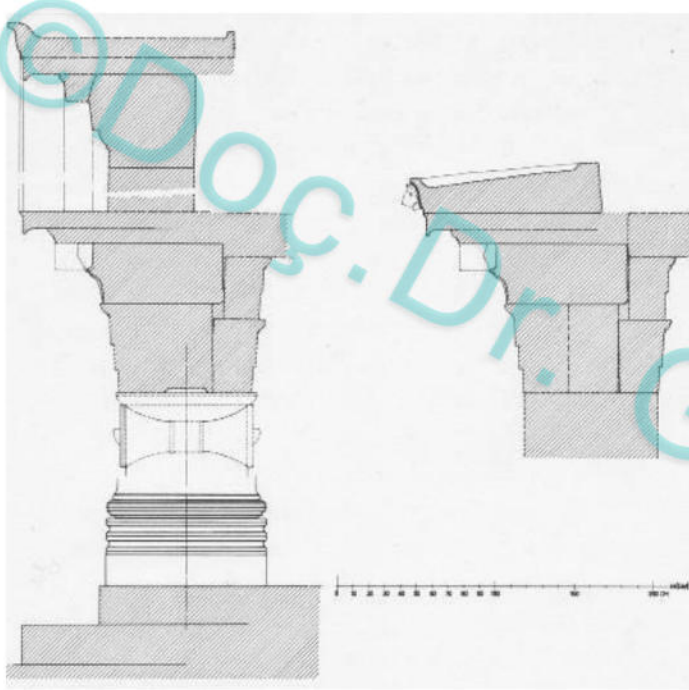
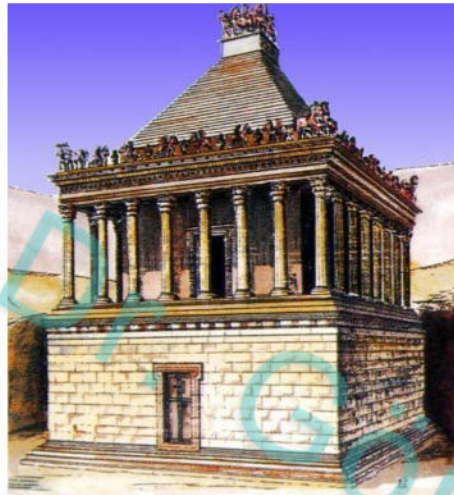
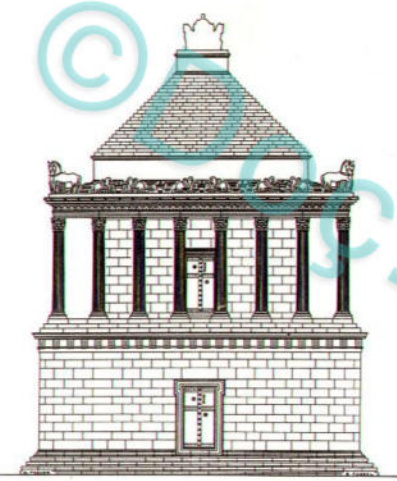

(28.8)

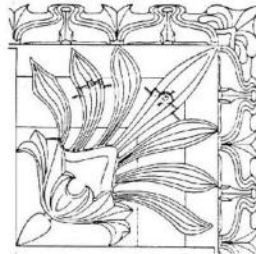

(28.9)

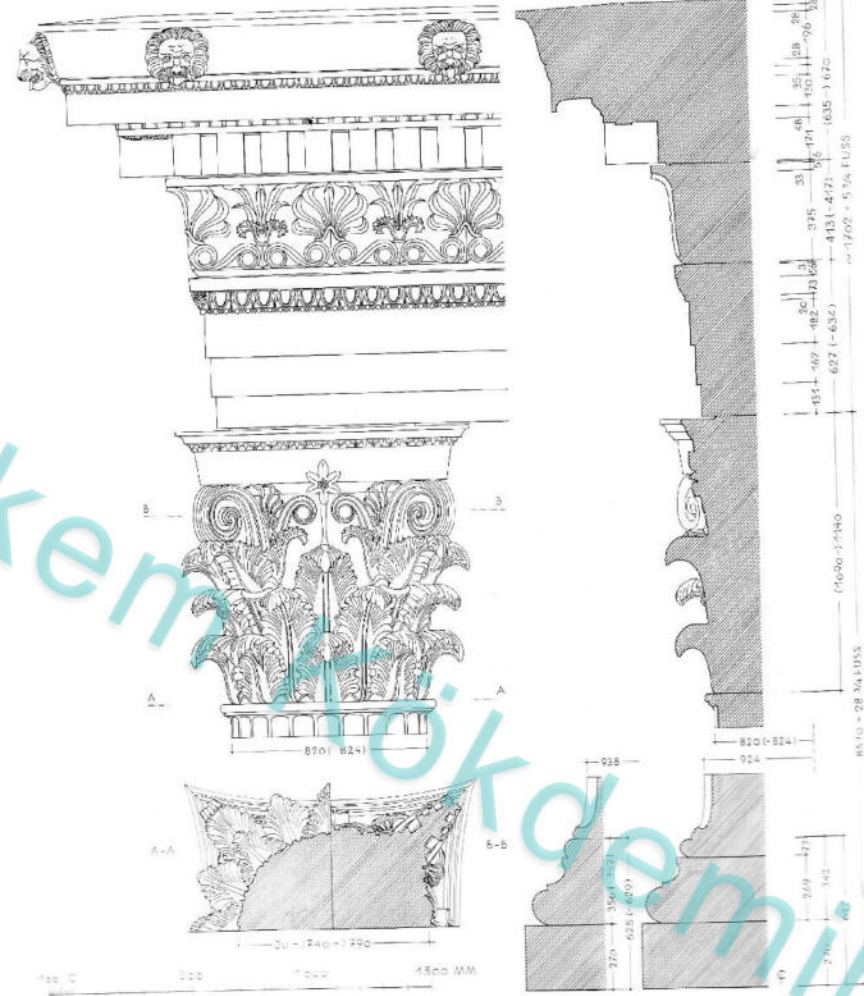

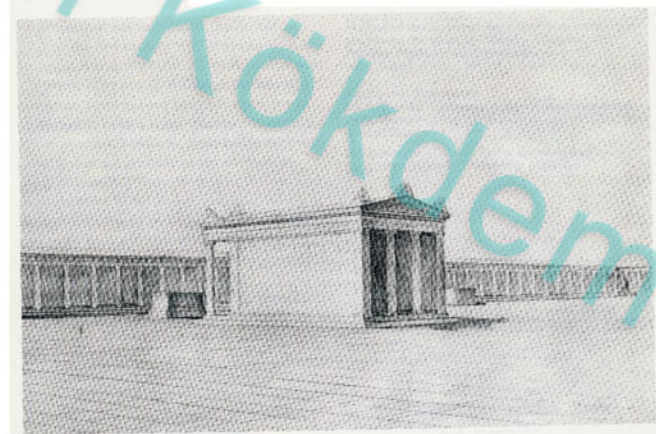
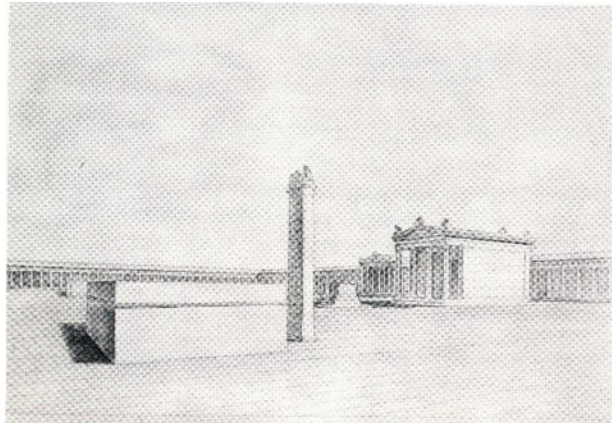
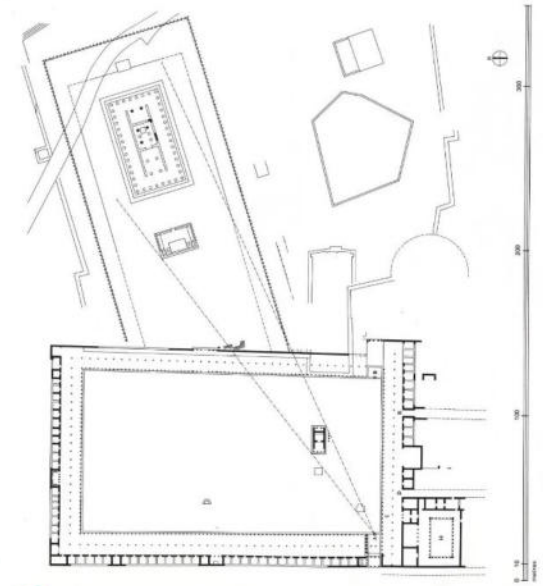
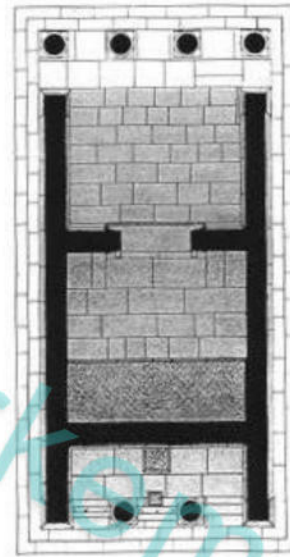

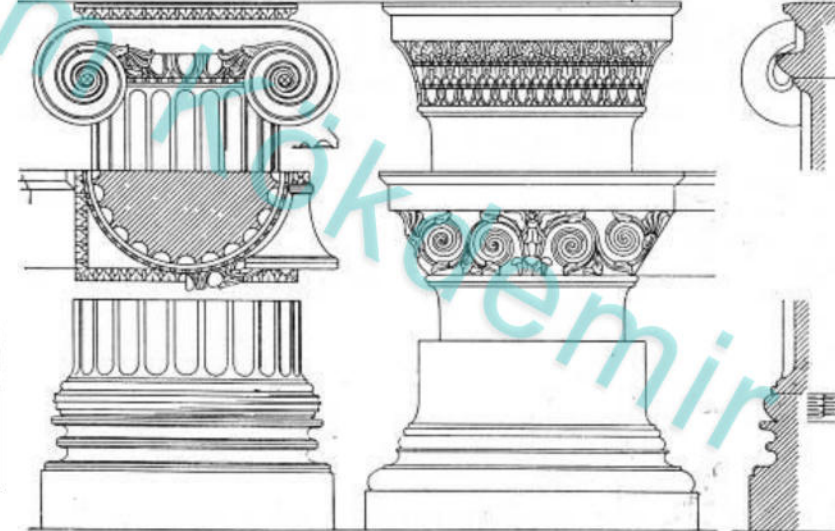
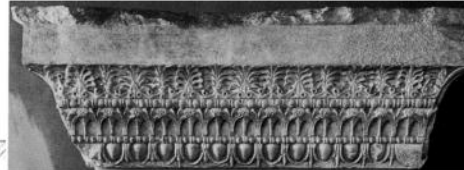
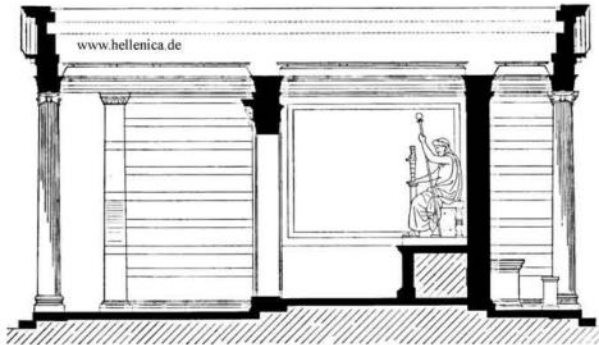
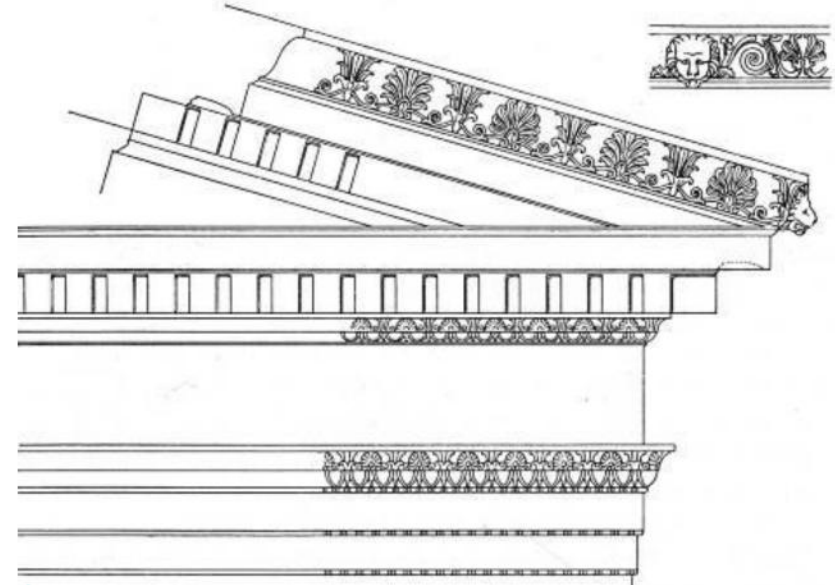

(KLA 301) HELLENİSTİK MİMARLIK



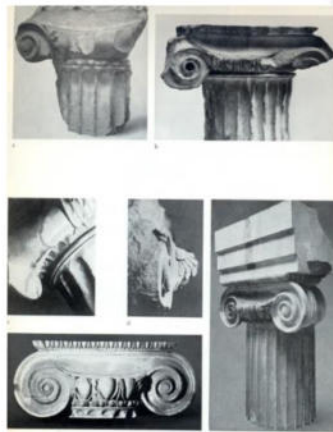
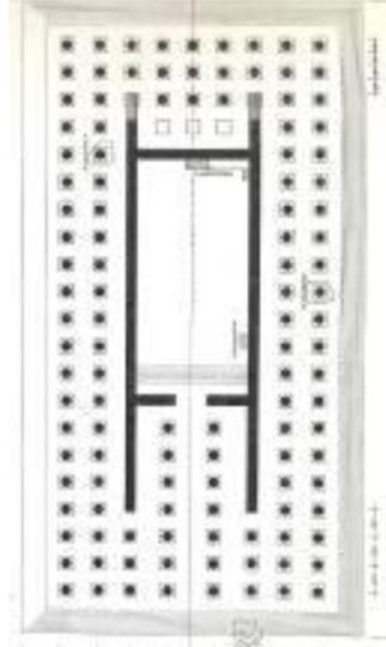
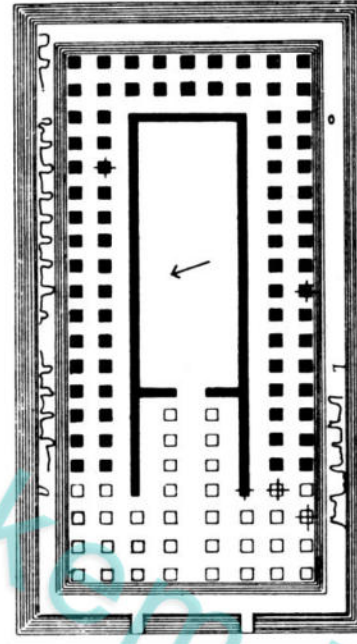
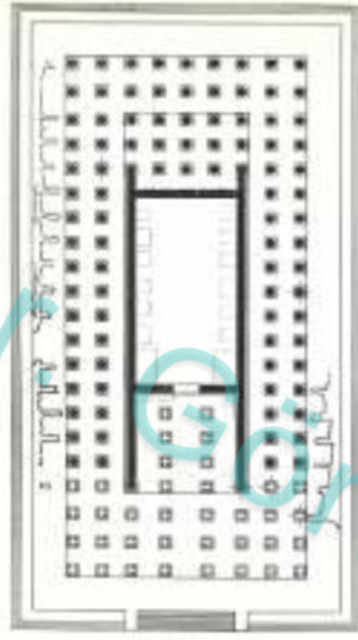
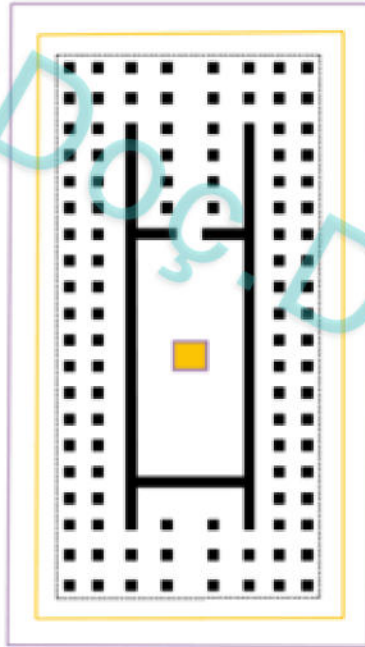



297 Ephesos, Jüngerer Artemision. Südwestecke. Rekonstruktion

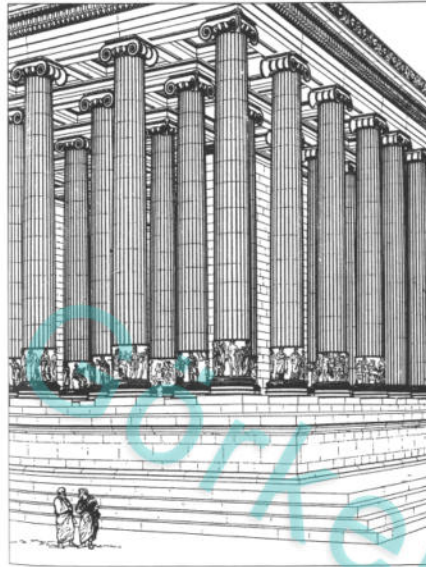



(KLA 301) HELLENİSTİK MİMARLIK

2020/2021

© Ankara Üniversitesi – Ders içeriklidir.
İzinsiz Yayınlanamaz – Kopyalanamaz

Doç. Dr. Görkem KÖKDEMİR

Ankara Üniversitesi

Dil ve Tarih-Coğrafya Fakültesi

Arkeoloji Bölümü, Klasik Arkeoloji Anabilim Dalı

(Öğretim Üyesi)

E-mail: gkokdemir@ankara.edu.tr