

**KLA 120**  
**ANTİK MİMARİDE MALZEME - TEKNİK**

**4. Hafta**

**KLA 120**

**ANTİK MİMARİDE MALZEME - TEKNİK**

**TAŞ - MERMER OCAKLARI**

**TAŞLARIN OCAKTAN TAŞINMASI**



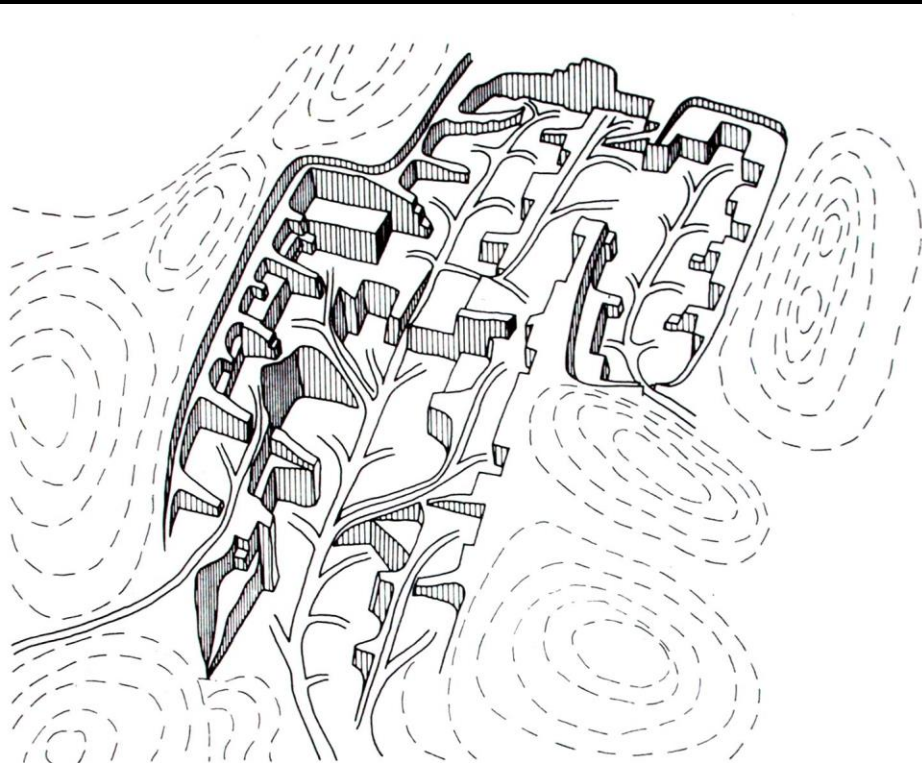
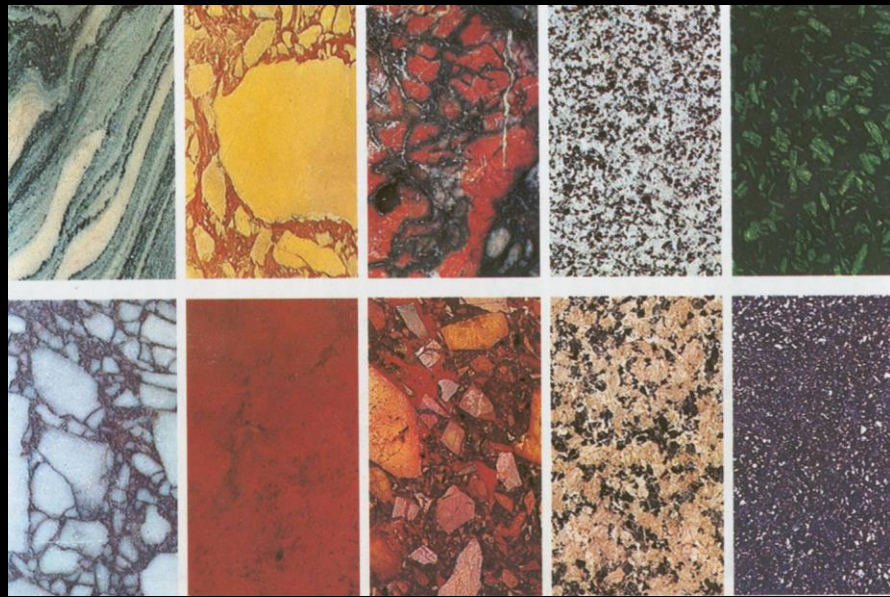

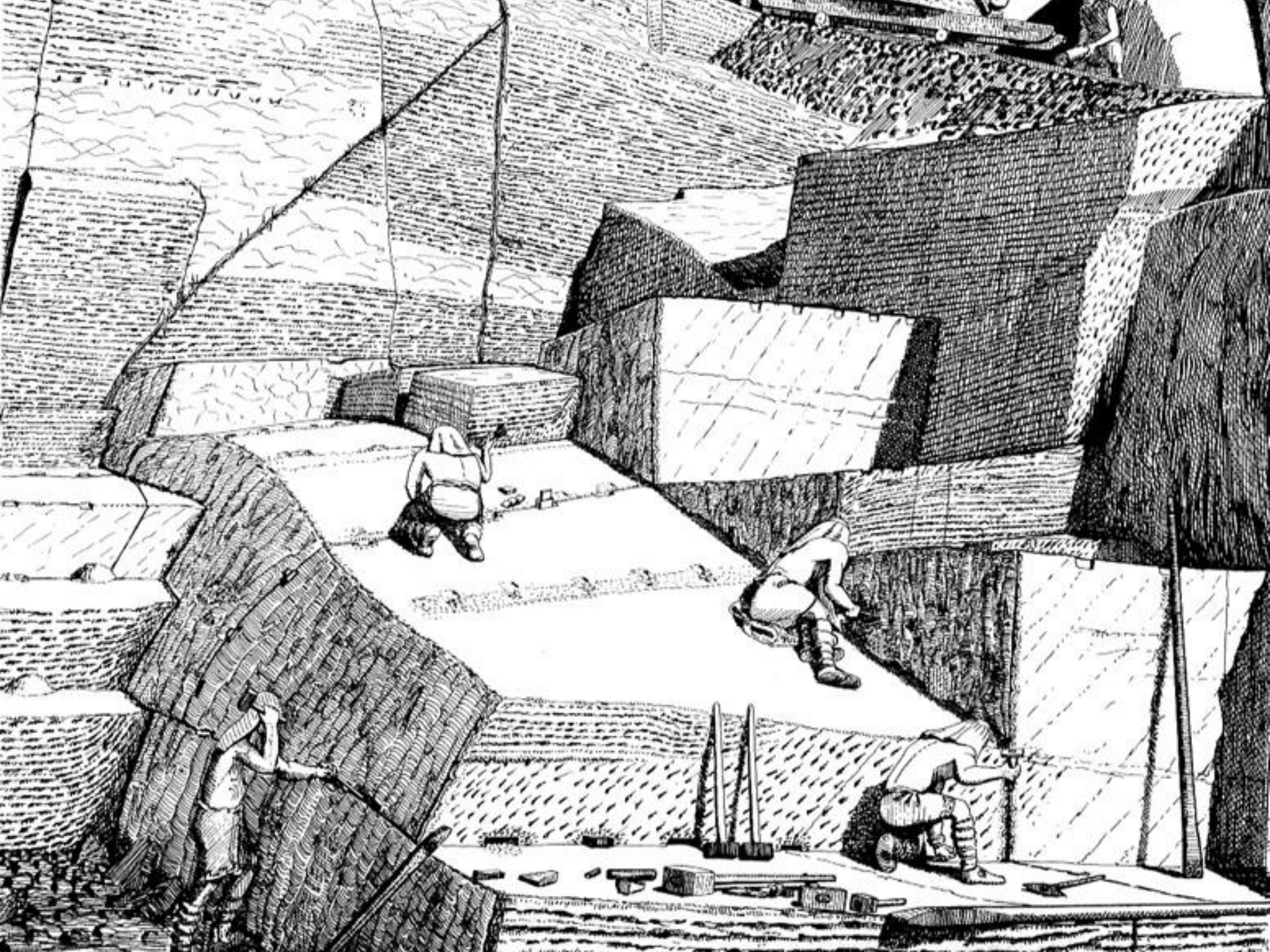

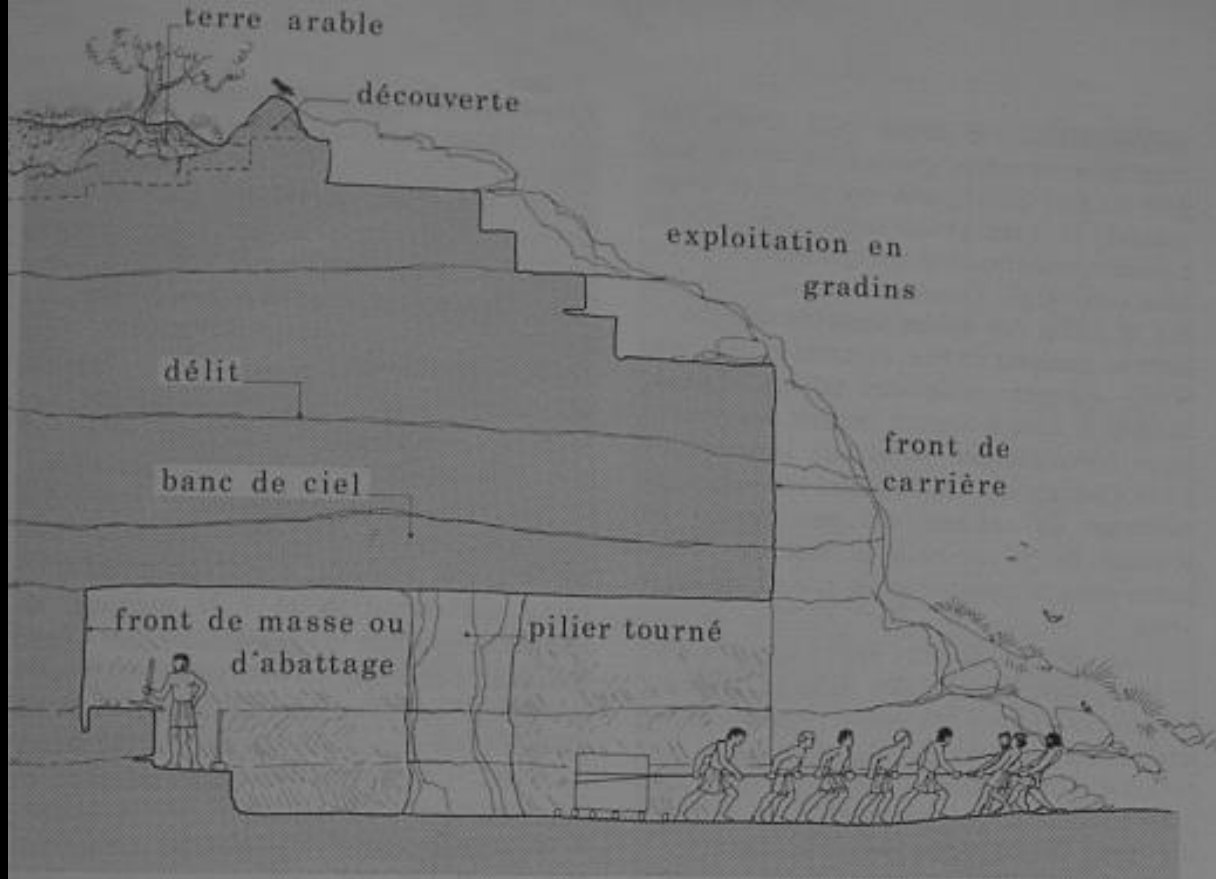

21





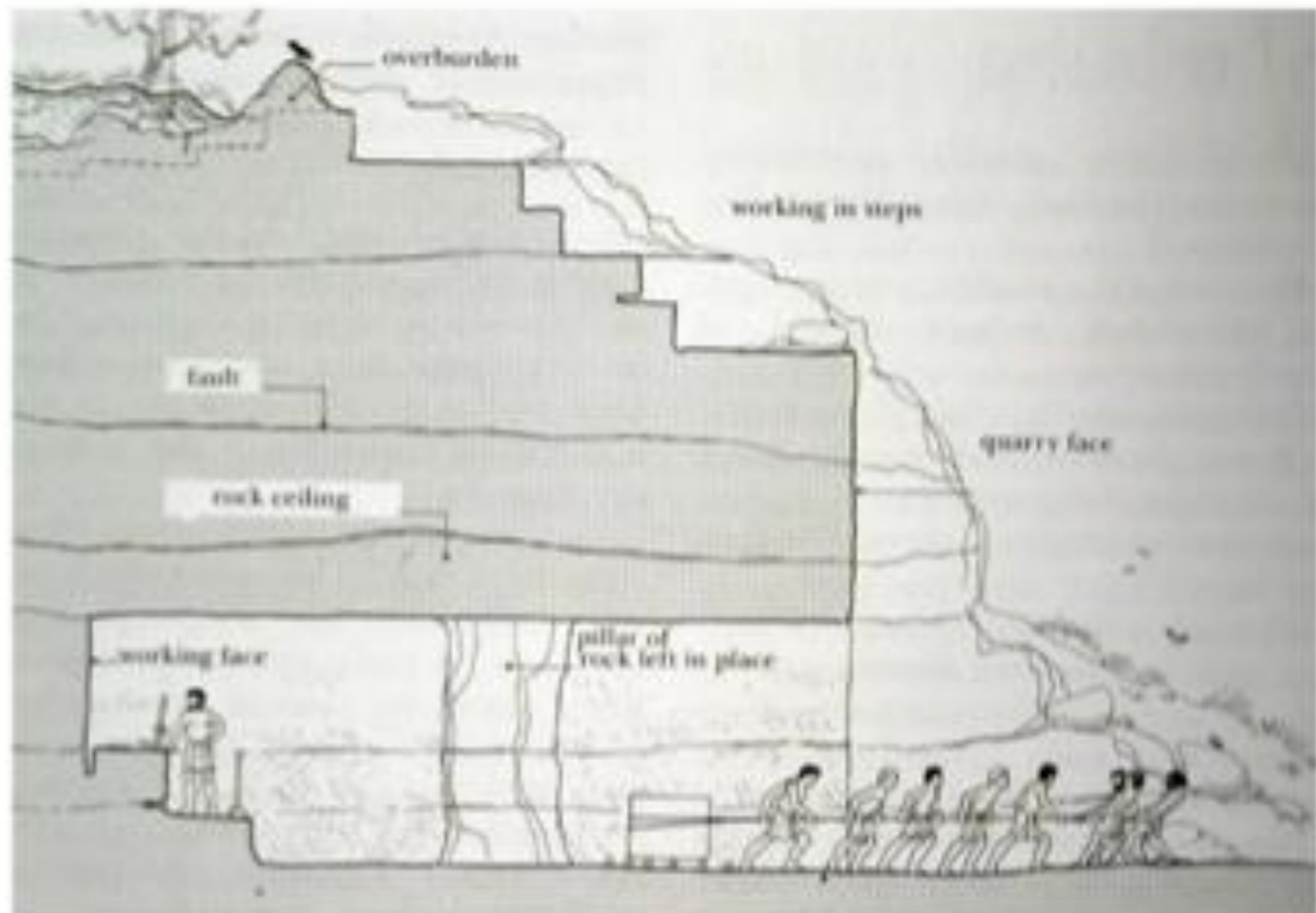

Kesilen taşın tomruklar üzerinde çekilerek taşınması, (Adam 1980, :



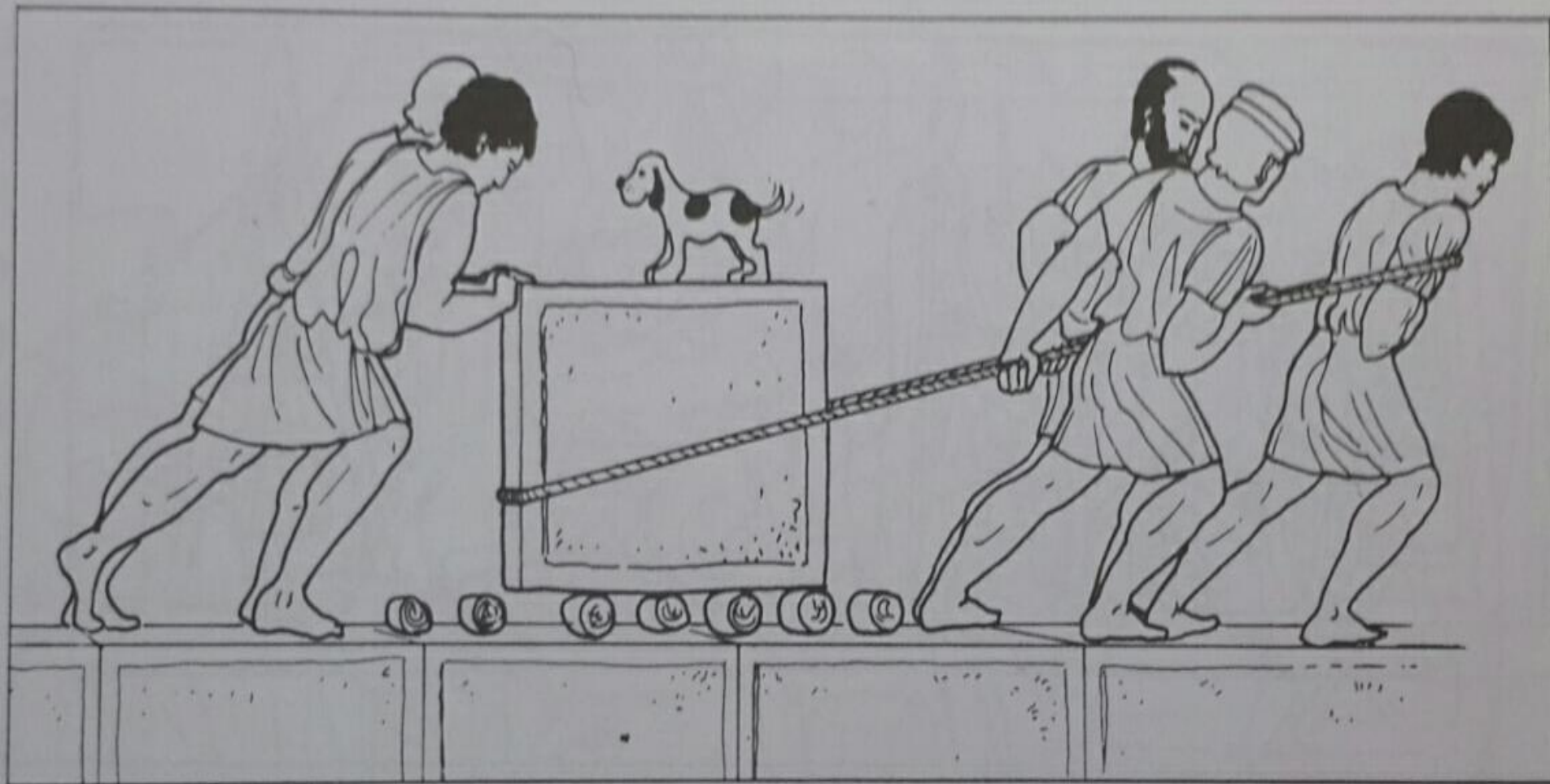

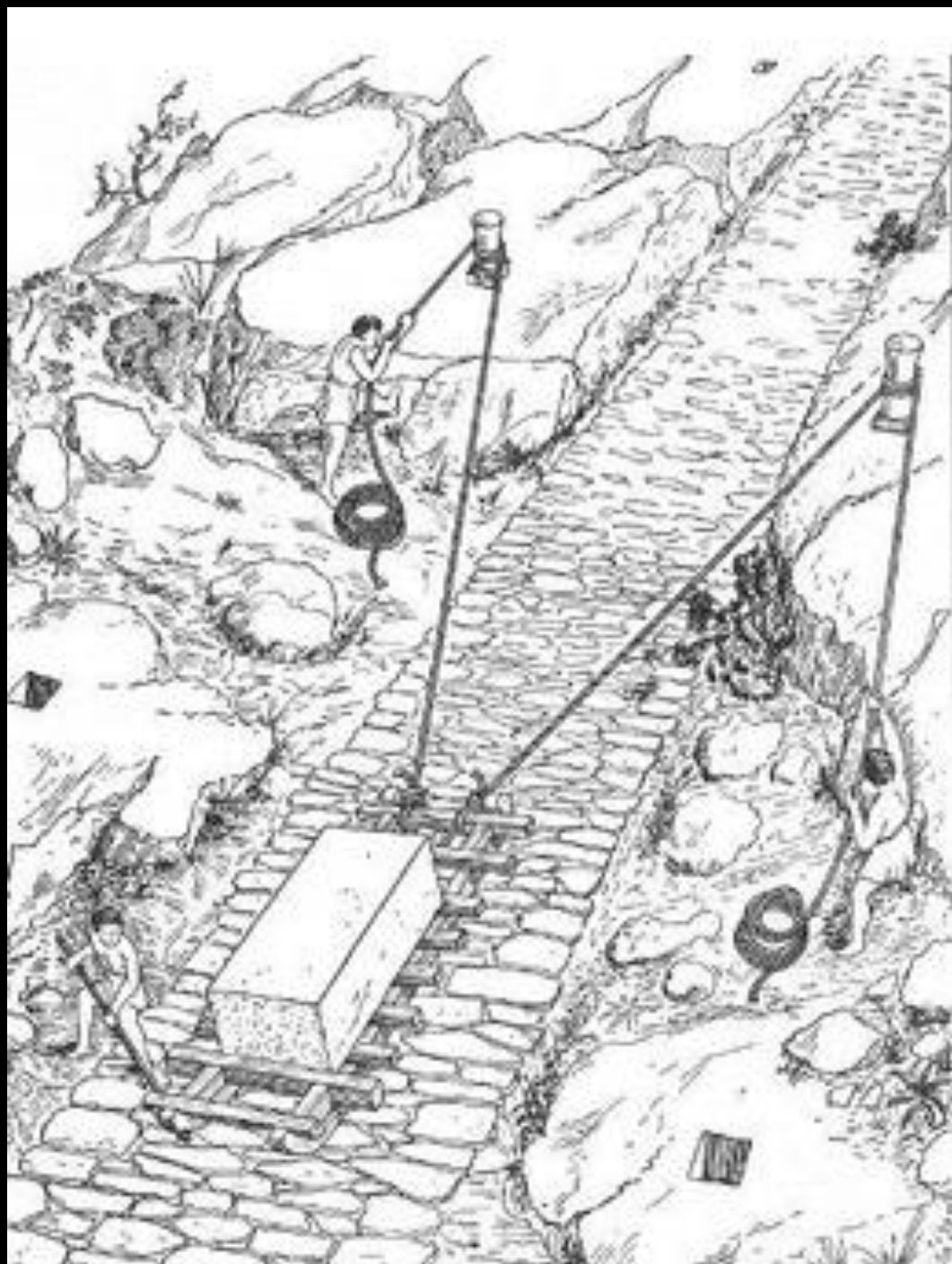

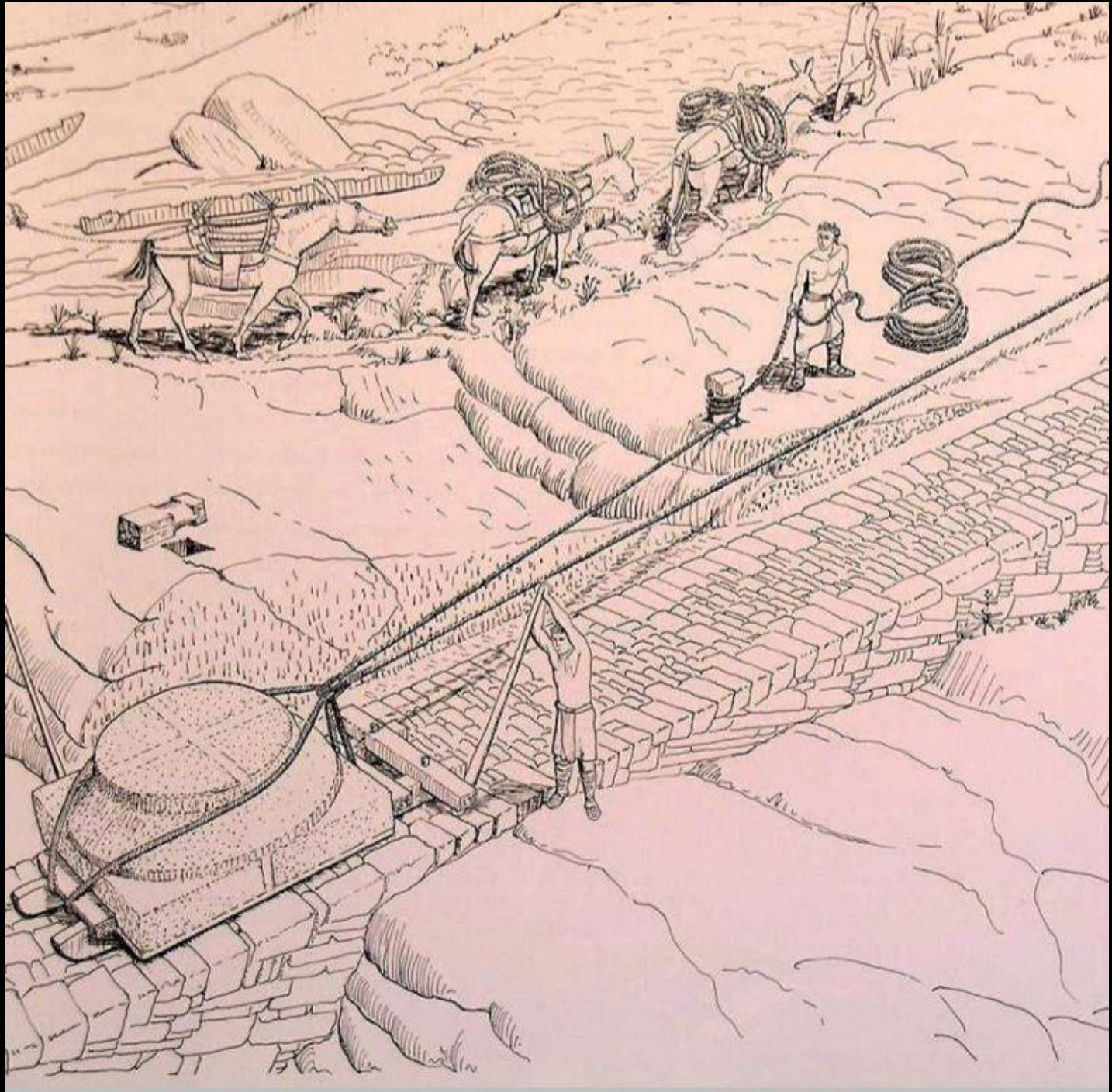

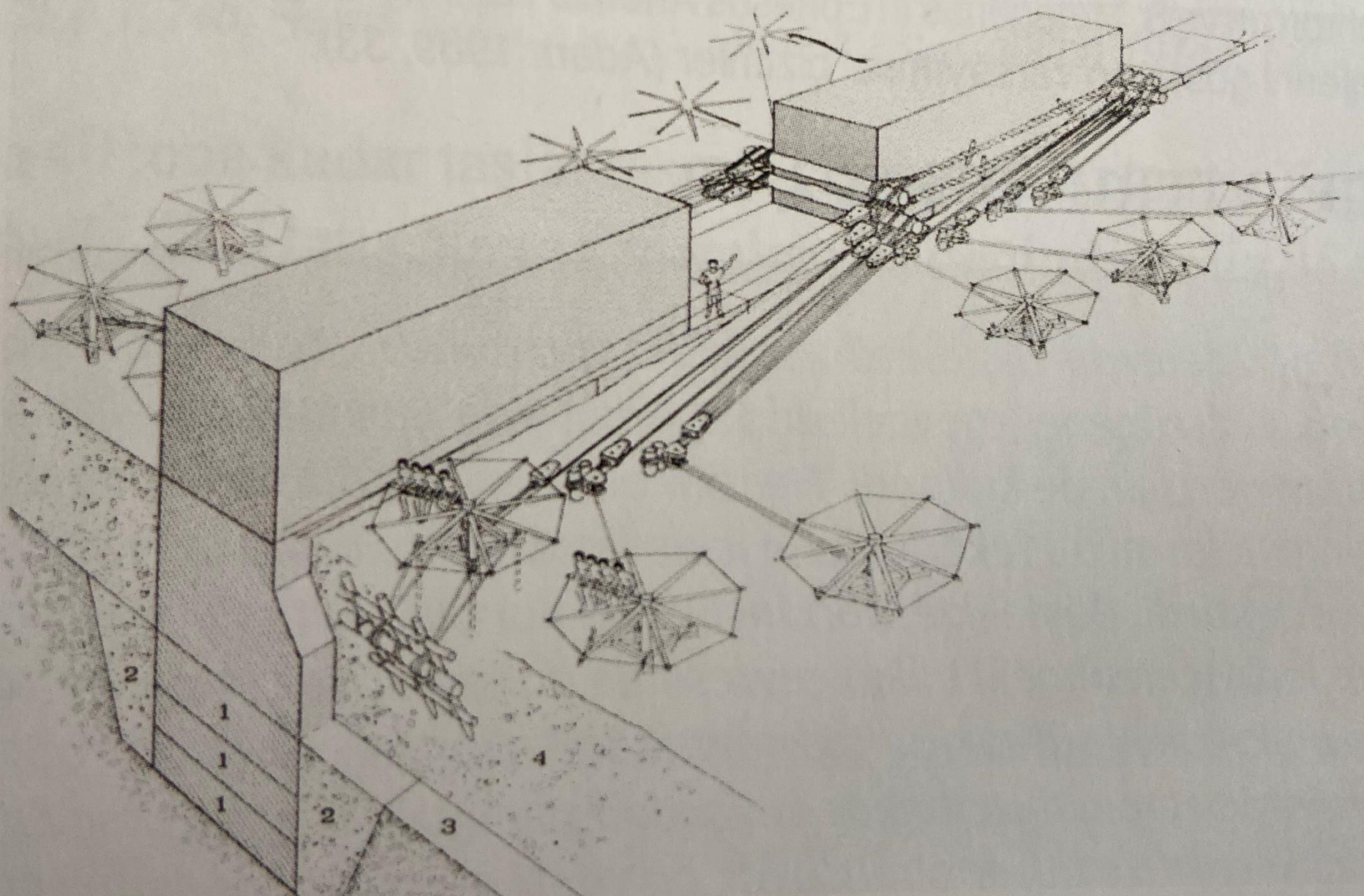

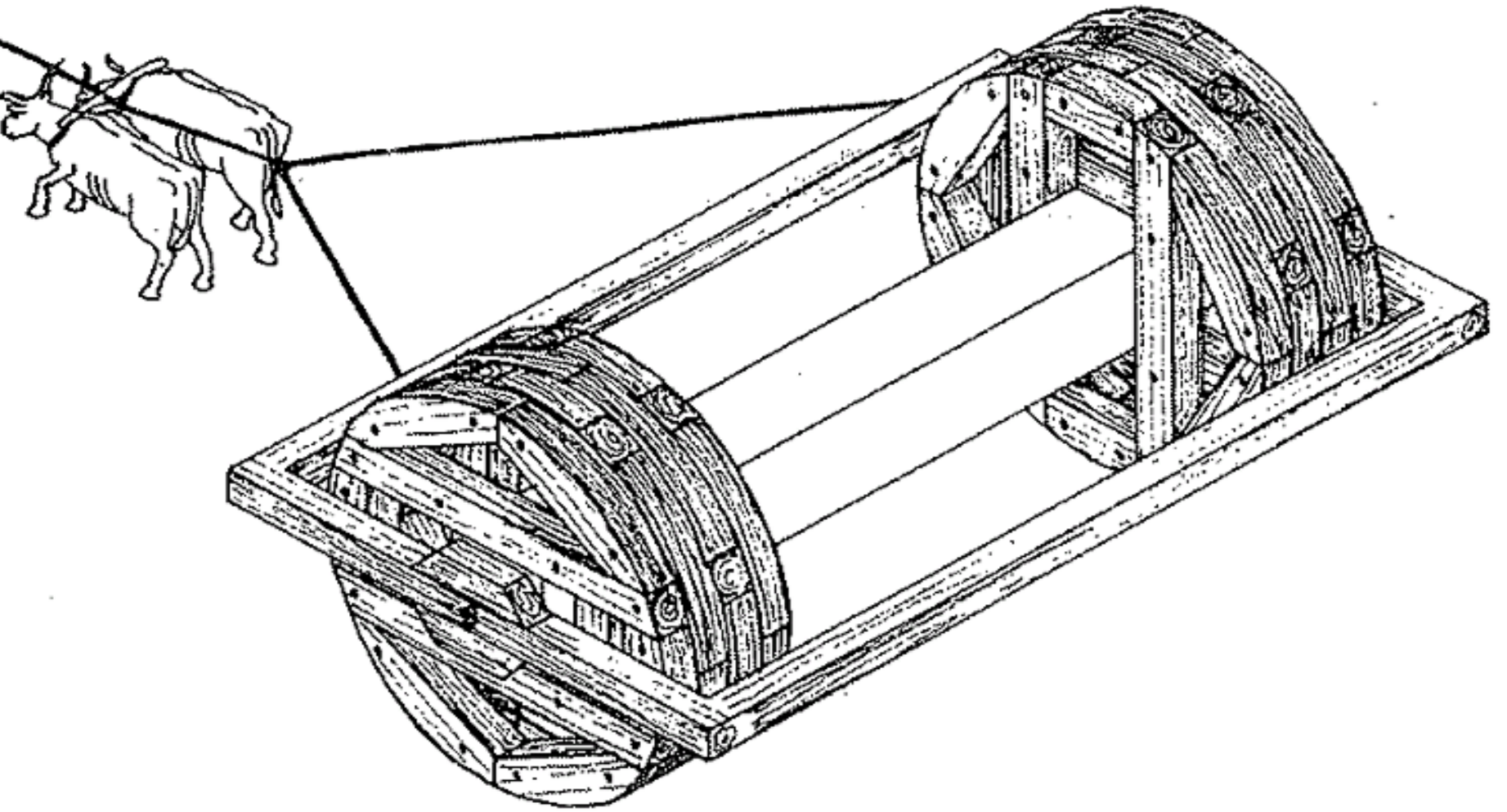

. Metagenes'in metoduna göre blokların taşınması (Coulton, Architects Fig. 62).

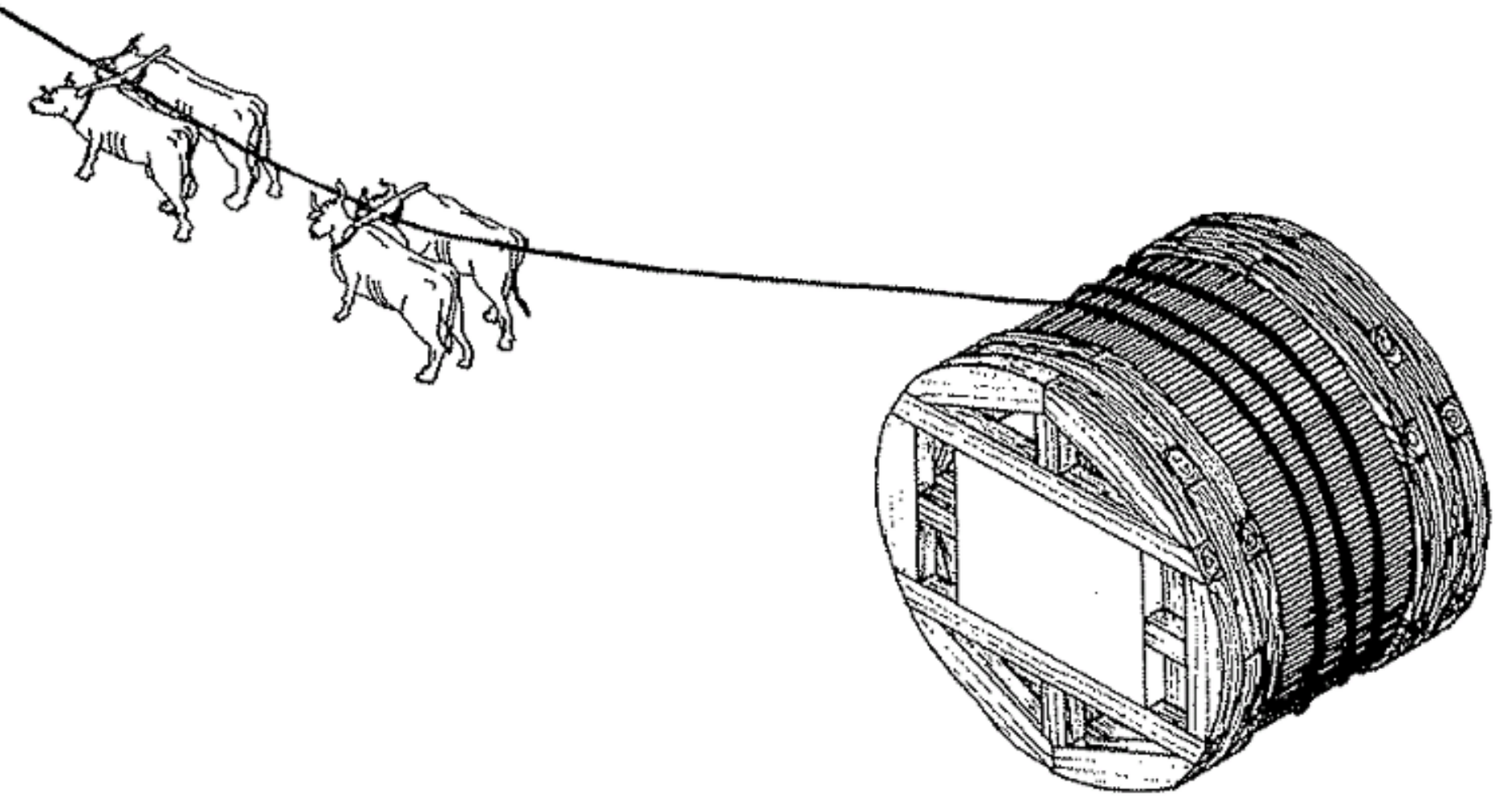

Paconius'un yöntemine göre blokların taşınması (Coulton, Architects Fig. 62).

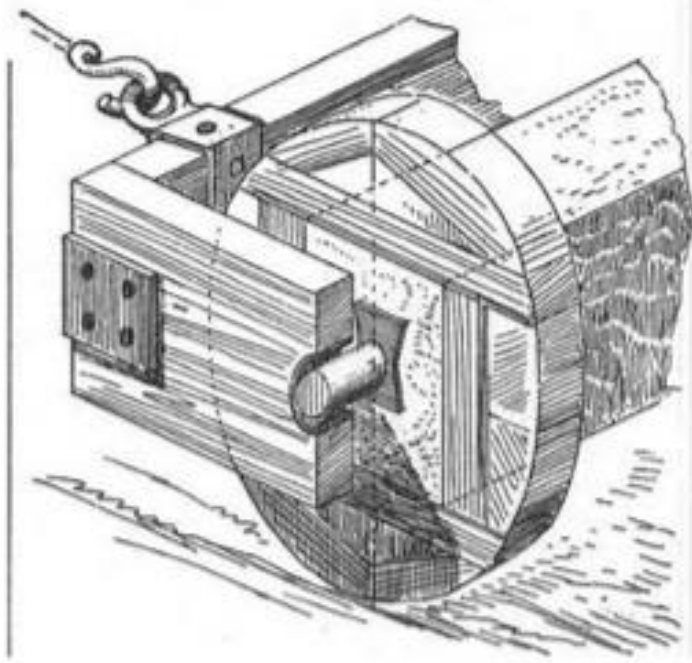

Taşa ahşap bir tekerlek giydirilerek taşınması (Orlandos 196

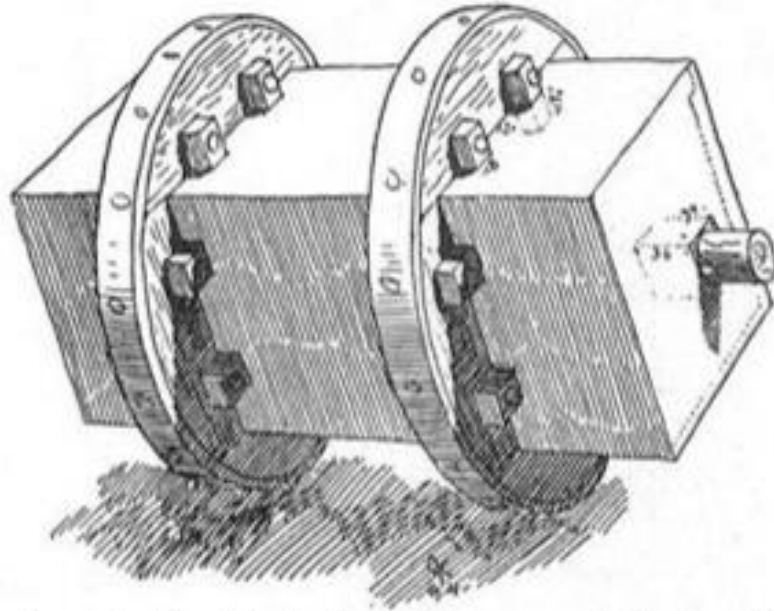

Taşa ahşap bir tekerlek giydirilerek taşınması (Orlandos 196

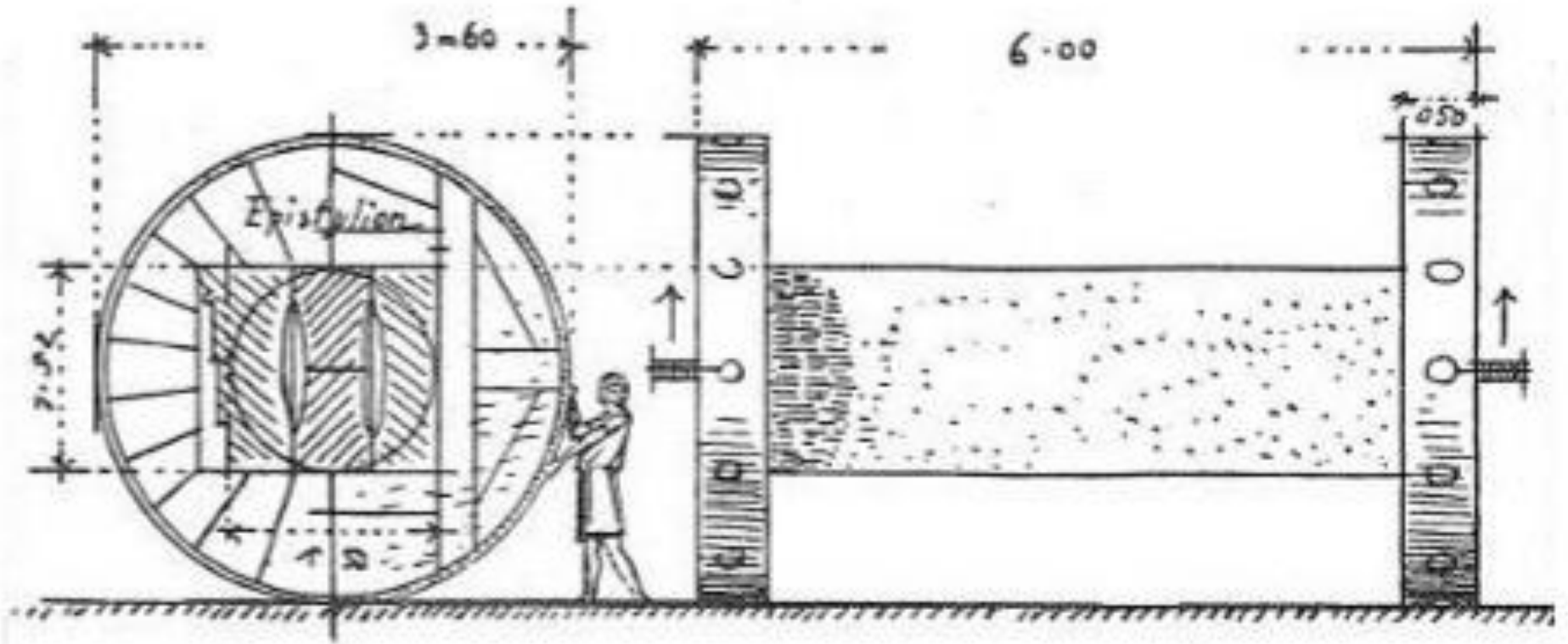

Resim 12. Taşa ahşap bir tekerlek giydirilerek taşınması (Orlandos 1968, 26, Fig. 10)



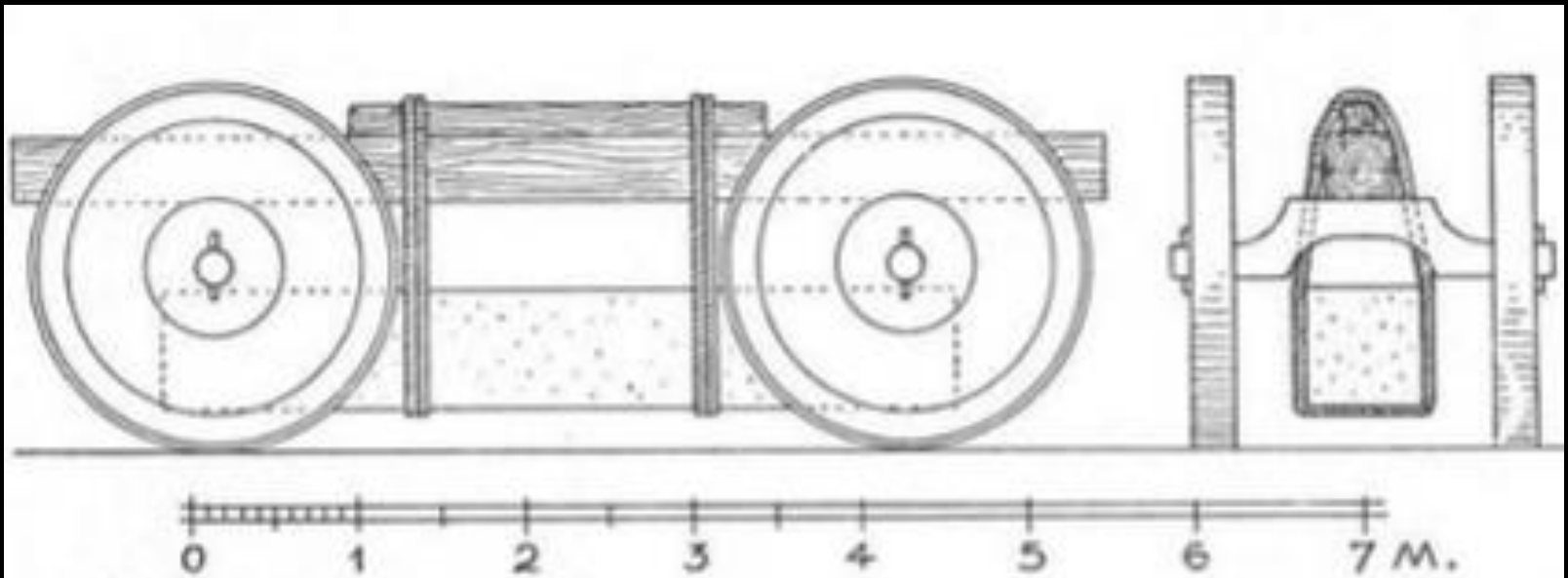

Resim 14. Taşa ahşap bir tekerlek giydirilerek taşınması (Orlandos 1968, 28, Fig. 13)

