

KLA 120
ANTİK MİMARİDE MALZEME - TEKNİK

9. Hafta

KLA 120

ANTİK MİMARİDE MALZEME - TEKNİK

TAPINAK MİMARİSİ

MİMARİ DÜZENLER

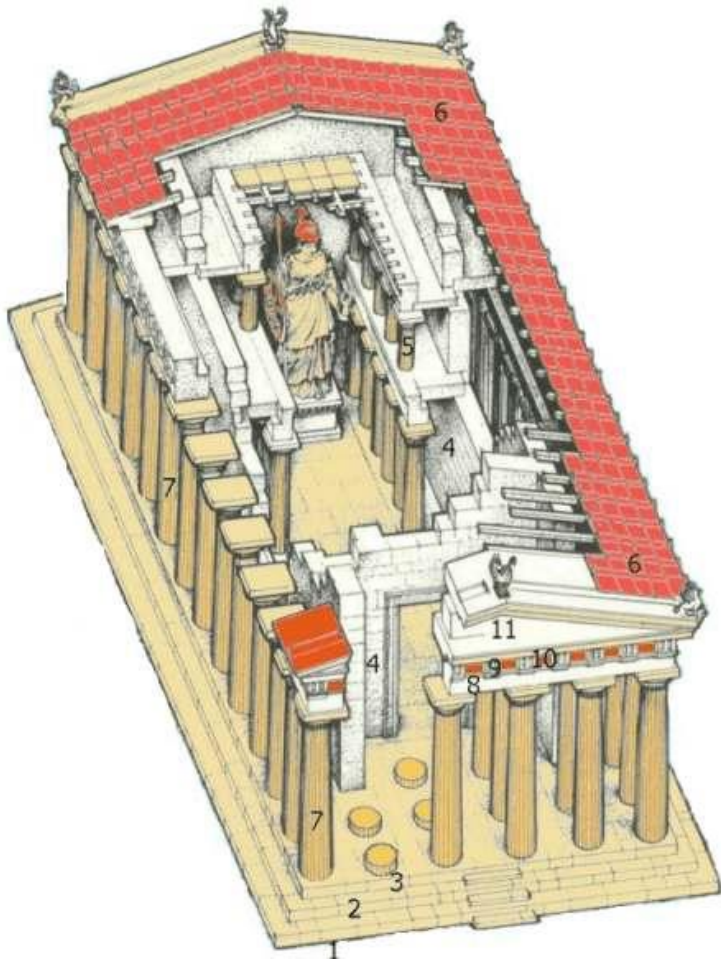

antik Yunan tapınağı

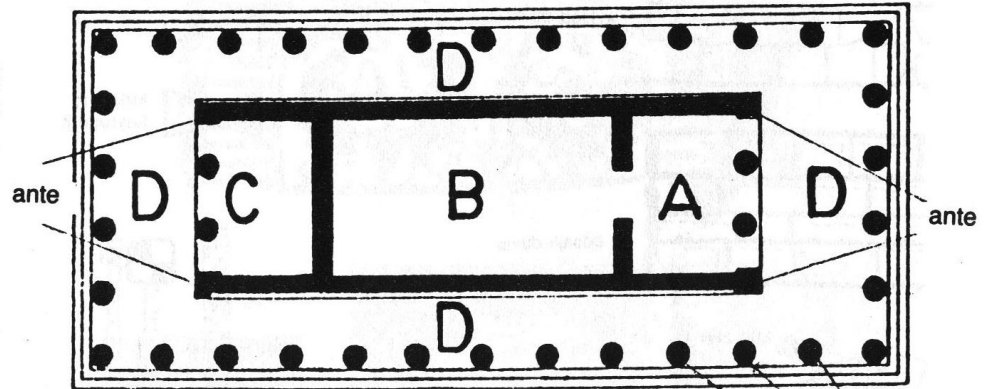

- A- pronaos
- B- naos (cella)
- C- opisthodomos
- D- pteroma

peristasis
(peristylum)

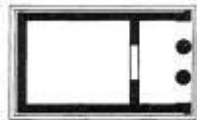

Antentempel

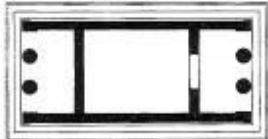

Doppelantentempel



Prostylis



Amphiprostylis (Athen, Ilistempel)

0 5 m

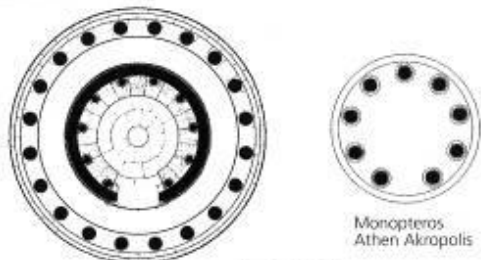

Tholos (Delphi)

Monopteros
Athen Akropolis

0 5 m

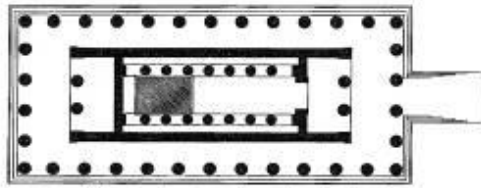

Peripteros (Olympia, Zeustempel)

0 10 20 m

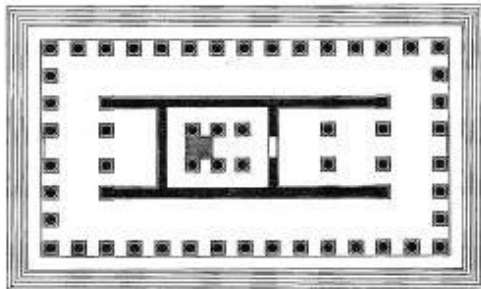

Pseudodipteros (Magnaesia, Artemision)

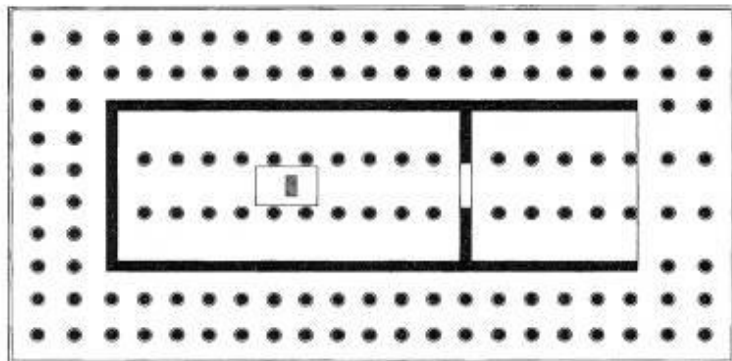

Dipteros (Samos, Rhoikastempel)

0 10 20 m



Abb. 12 Klaros, Apollontempel



Abb. 13 Xanthos, Letoon

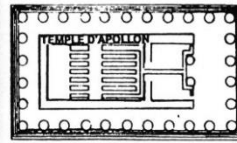

Abb. 14 Pergamon, Trajaneum

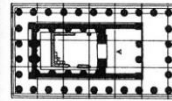

Abb. 15 Side, Apollontempel

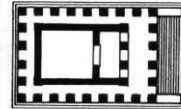

Abb. 16 Sagalassos, Antoninus-Pius-Tempel

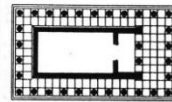

Abb. 17 Termessos, Zeus-Solymius-Tempel

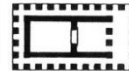

Abb. 18 Teos, Dionysostempel

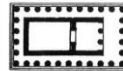

Abb. 19 Euromos, Zeustempel

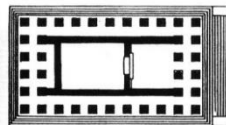

Abb. 22 Magnesia, Artemistempel

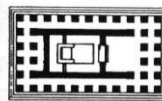

Abb. 20 Lagina, Hekateion

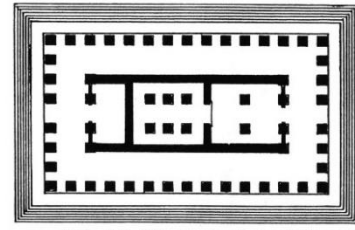

Abb. 23 Ankyra, Augustus- und Romatempel

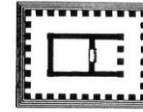

Abb. 21 Pergamon, Dionysostempel

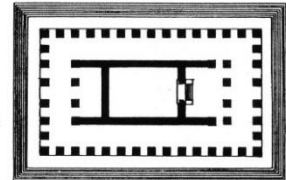

Abb. 24 Aphrodisias, Aphroditetempel

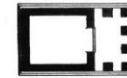

Abb. 25 Sardeis, frühkaiserzeitlicher Tempel

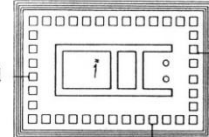

Abb. 26 Ephesos, Domitianstempel

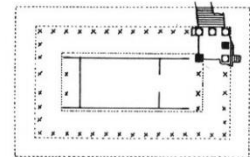

Abb. 27 Aizanoi, Zeustempel

0 40

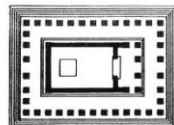
Başlıca Mimari Düzenlerdeki Başlık Tipleri

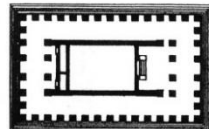
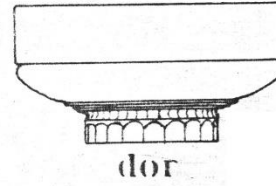

- DOR DÜZENİ
- İON DÜZENİ
- AEOL DÜZENİ
- KORİNTH DÜZENİ
- KOMPOZİT DÜZEN

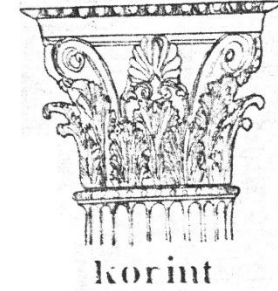
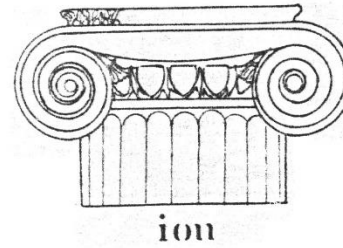

DOR DÜZENİ

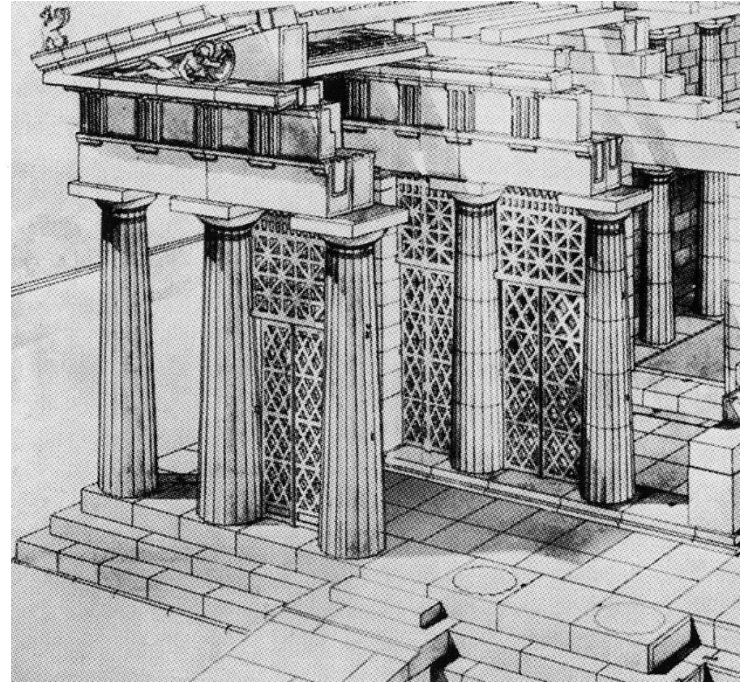
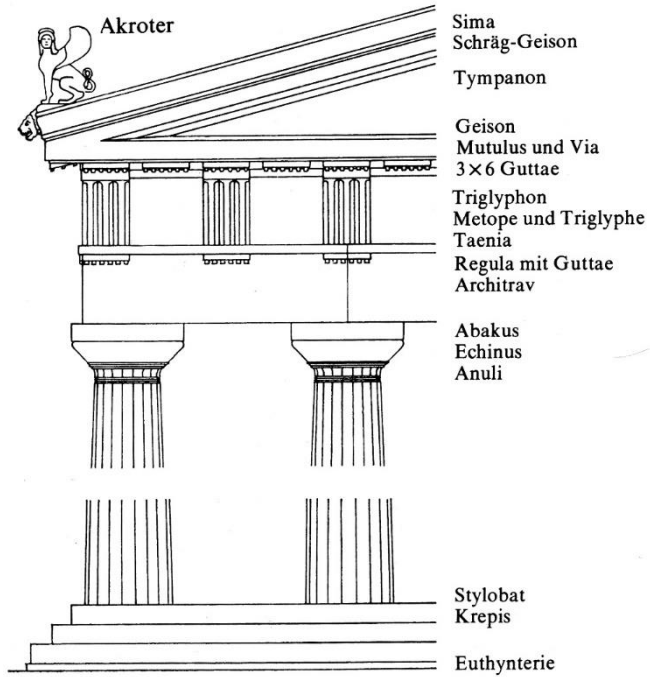

AEGİNA APHAİA TAPINAĞI

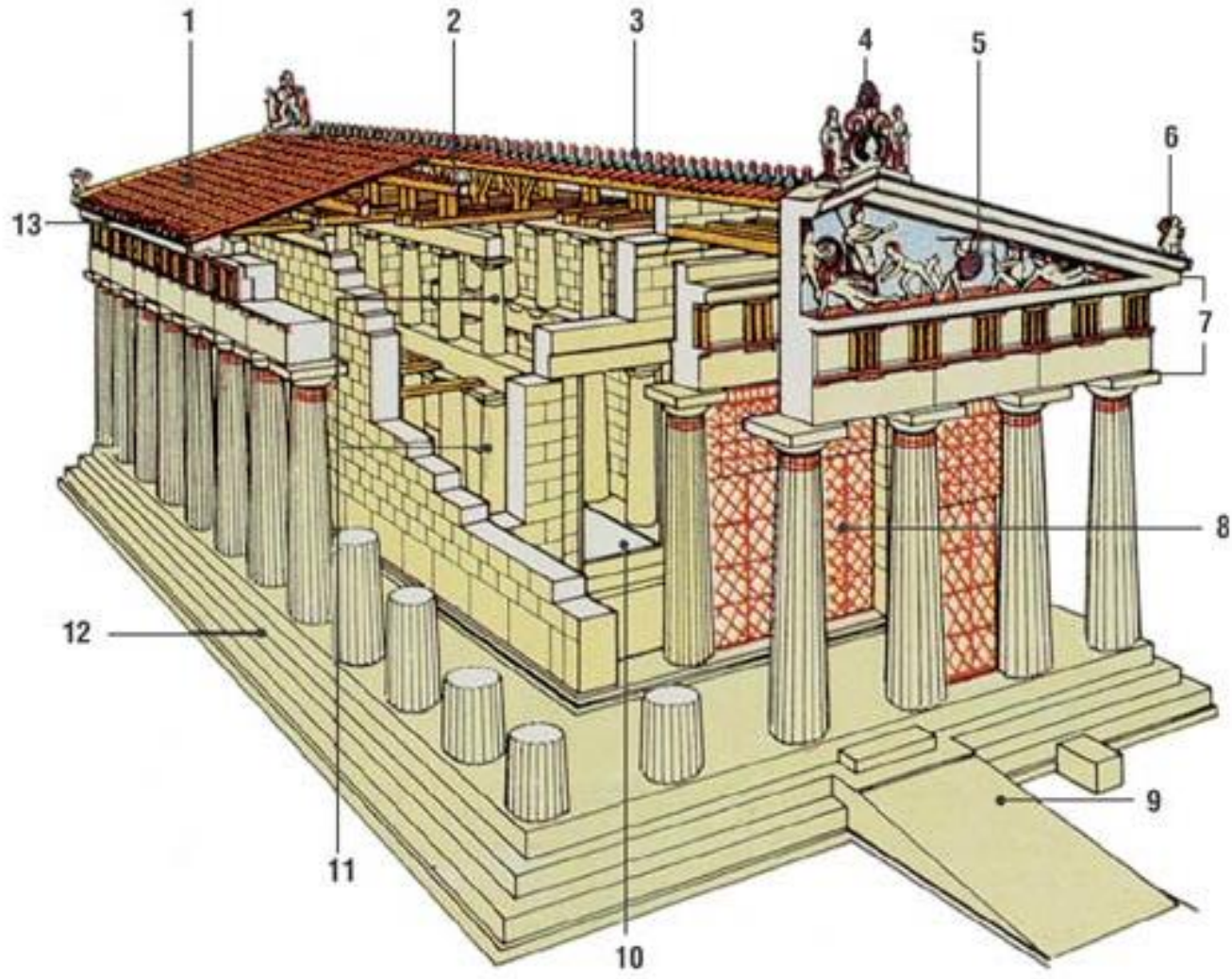

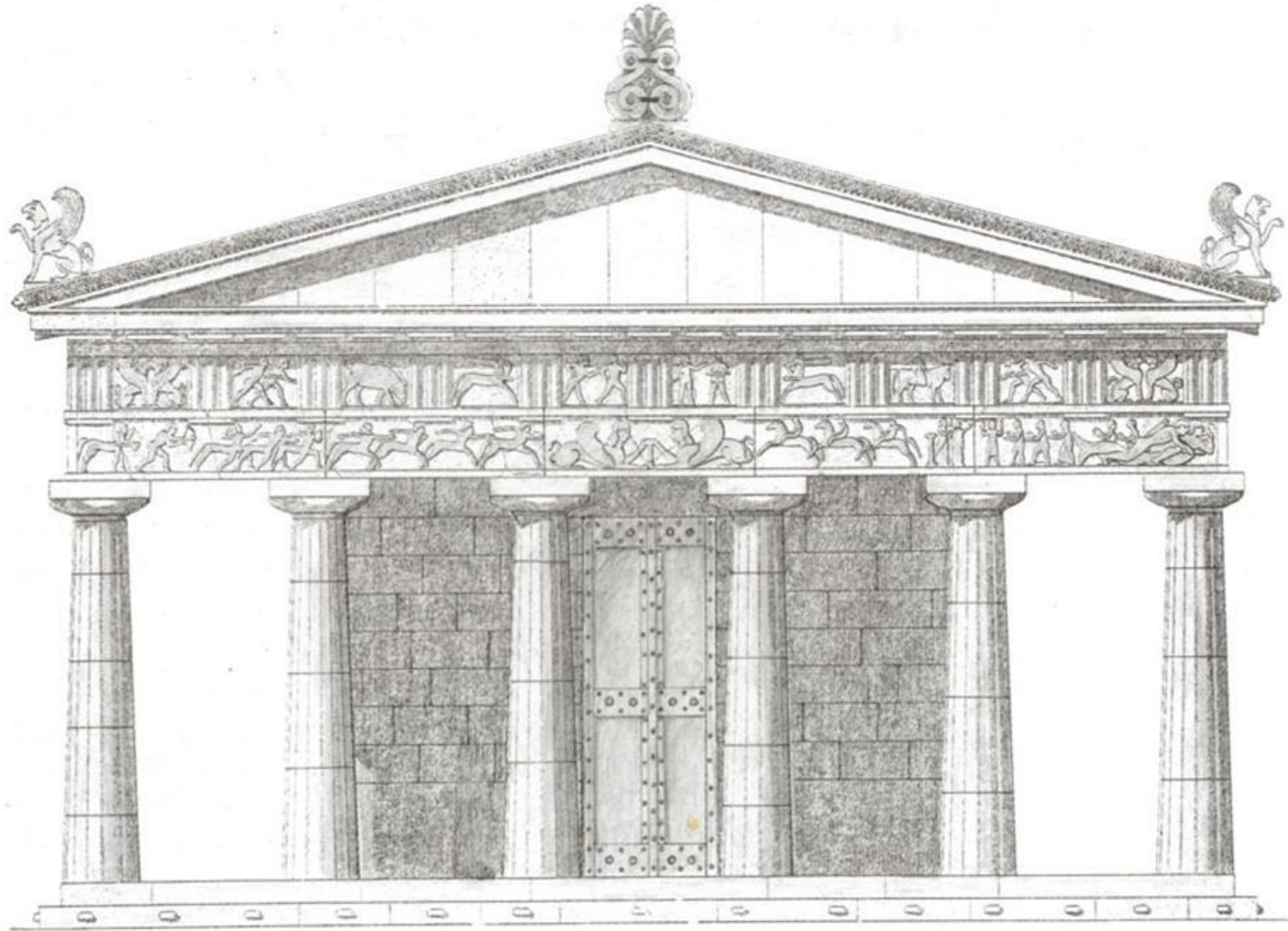

ION DÜZENİ

FUNDAMENT, EUTHYNTERIE, KREPIS, STYLOBAT, TOICHOBAT. s. dorische Ordnung.



Abb. 21: Ionische Ordnung, Tempel der Athena Polias in Priene, Schema

PRIENE ATHENA TAPINAĐI REKONSTRÜKSİYONU



Res. 97 Athena Tapınađı. Güneydođudan görünüşünün isometrik rekonstrüksiyonu.

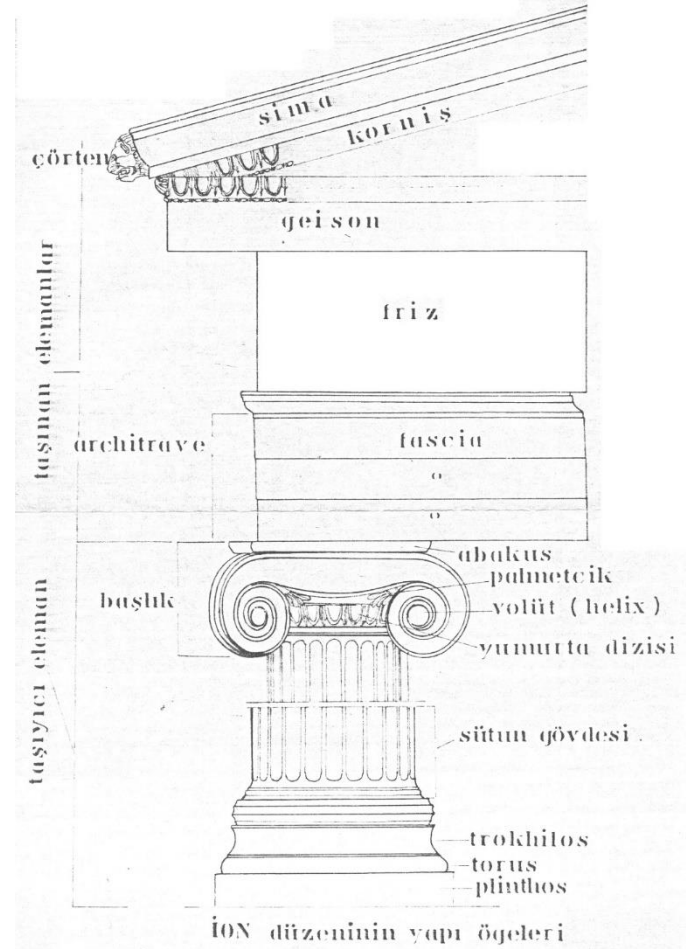
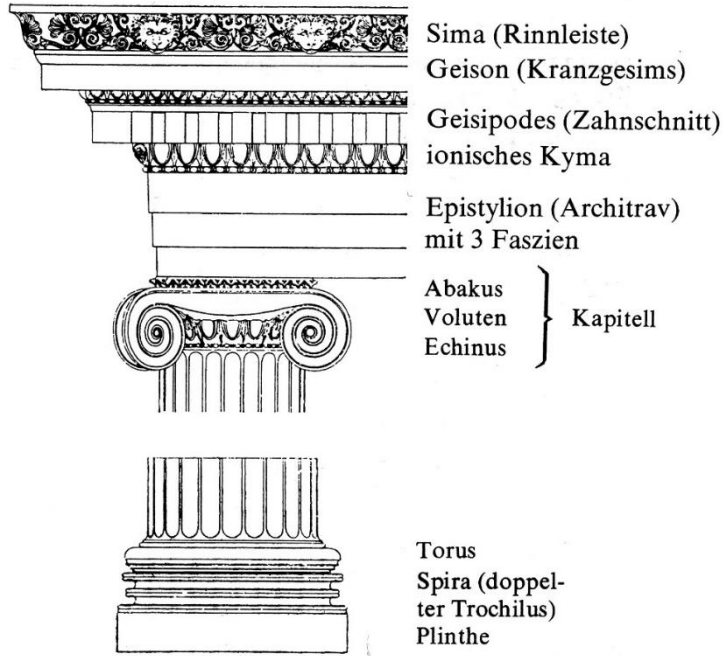
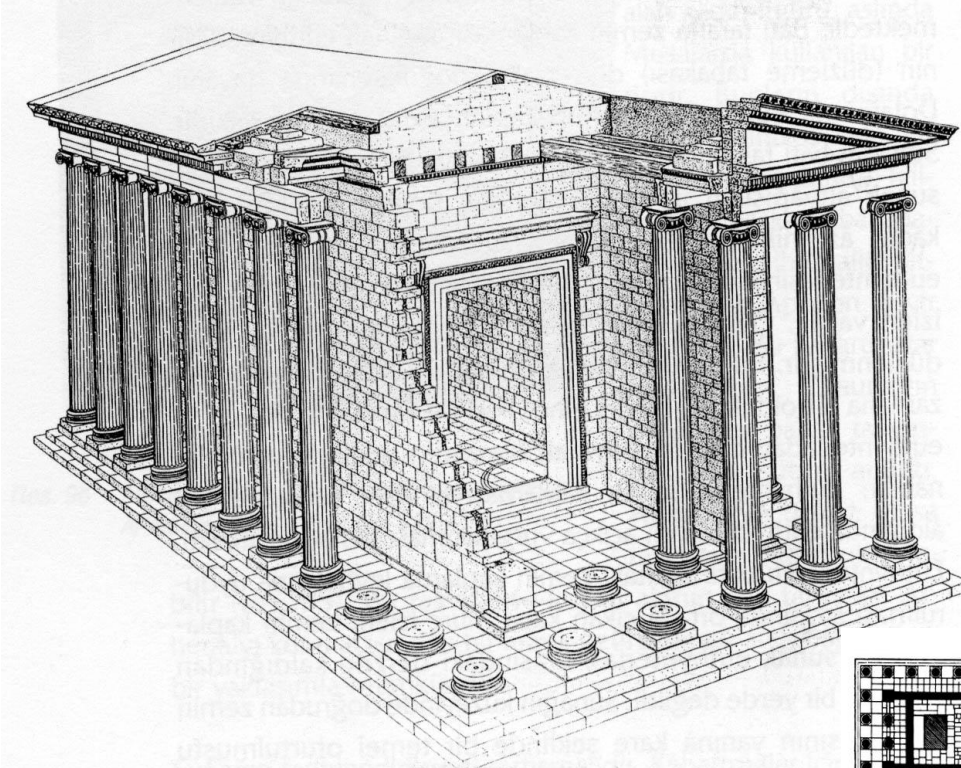

Res. 95 Athena Sunađı. Güneydođudan görünüşünün rekonstrüksiyonu.

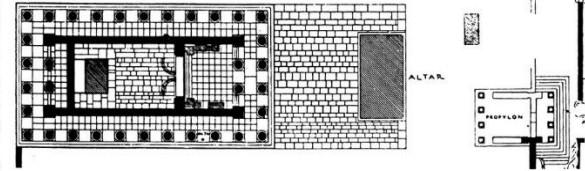

315 Priene, Athena Polias-Tempel mit Altar und Propylon. Grundriß (1 : 800)

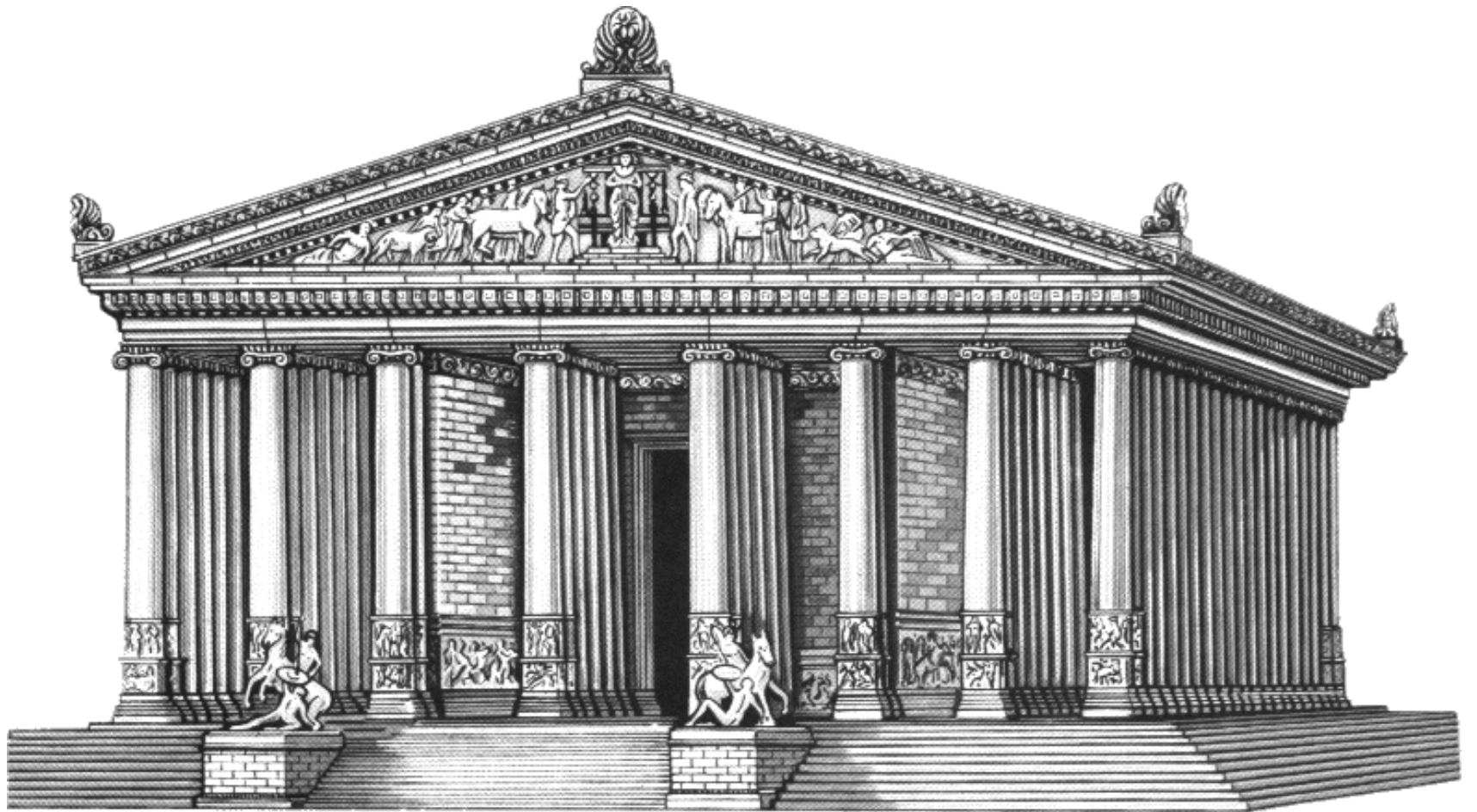

İON BAŞLIĞI

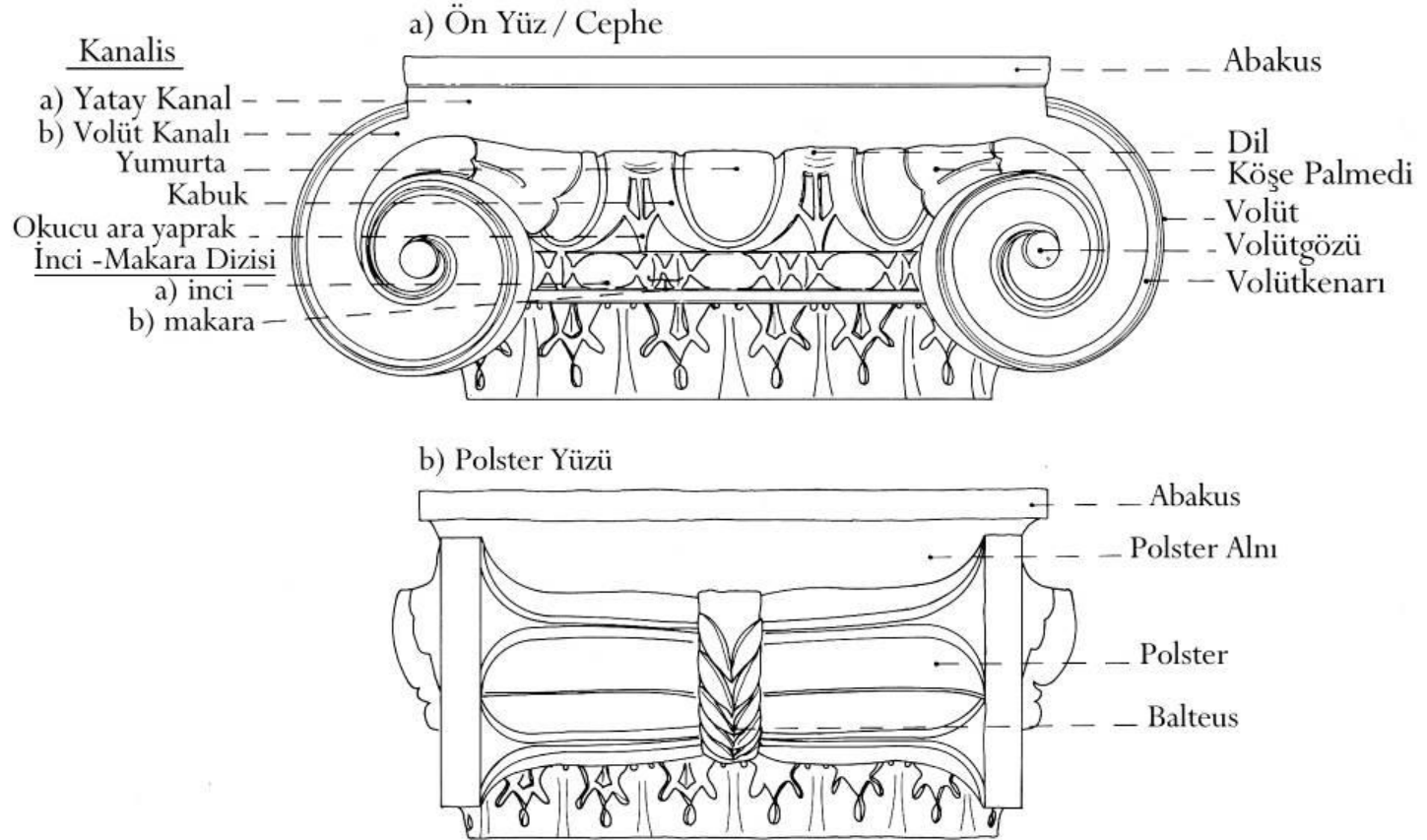



272 - Athen. Stölenbasis des Nike-Tempels

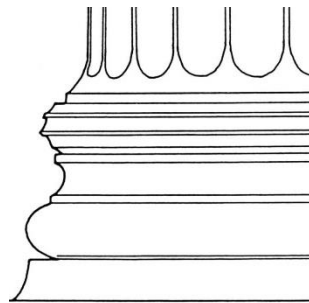
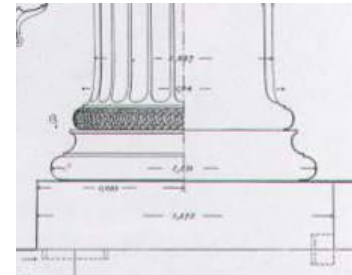
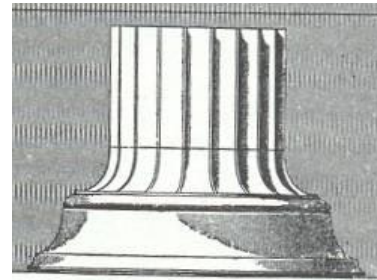

Korint Düzeneinin Mimari Öğeleri

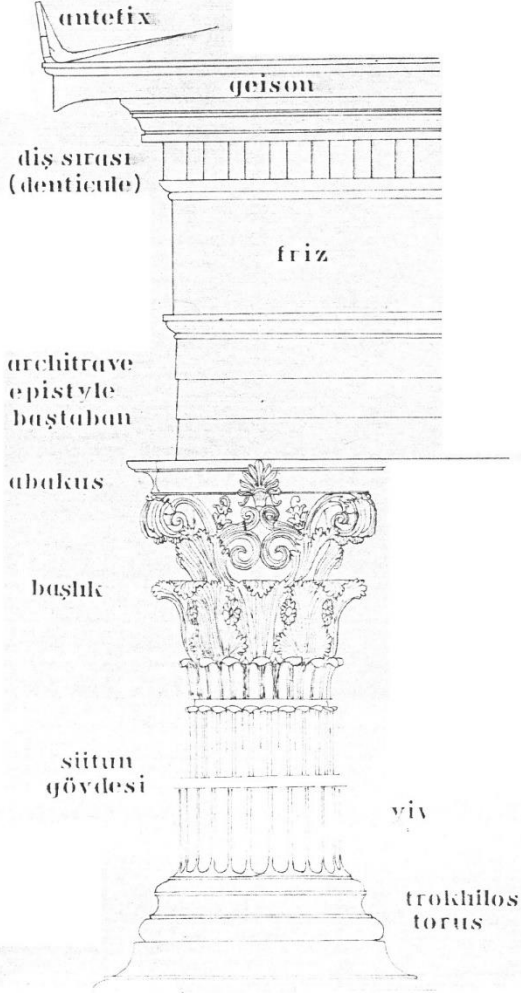

KOMPOZİT DÜZENİN MİMARİ ÖGELERİ

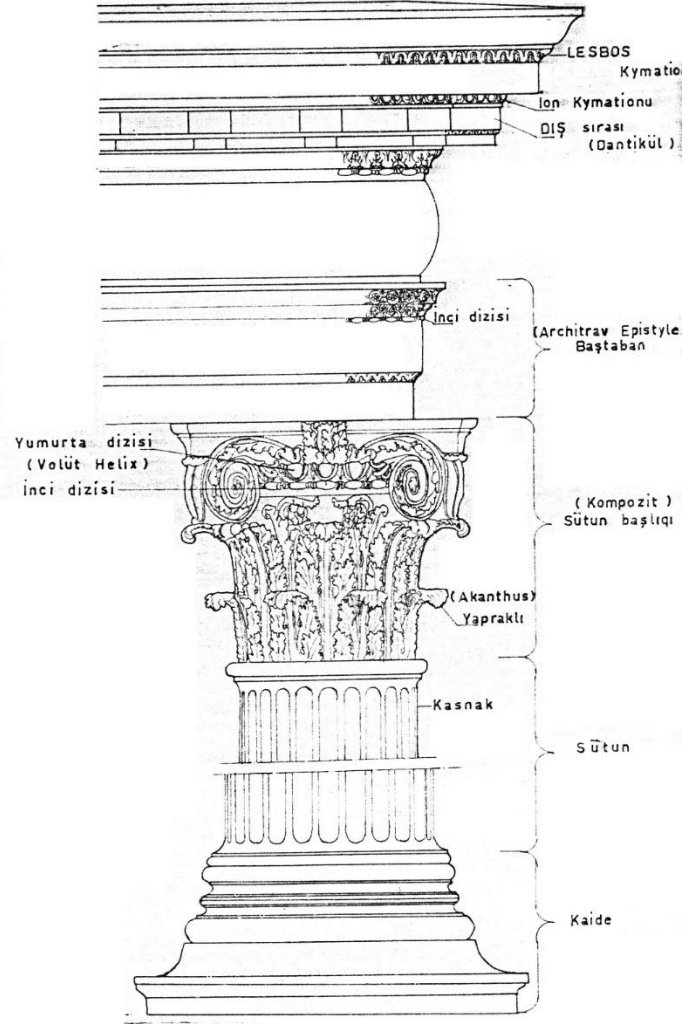

Korinth



Komposit



KORİNTH BAŞLIĞI

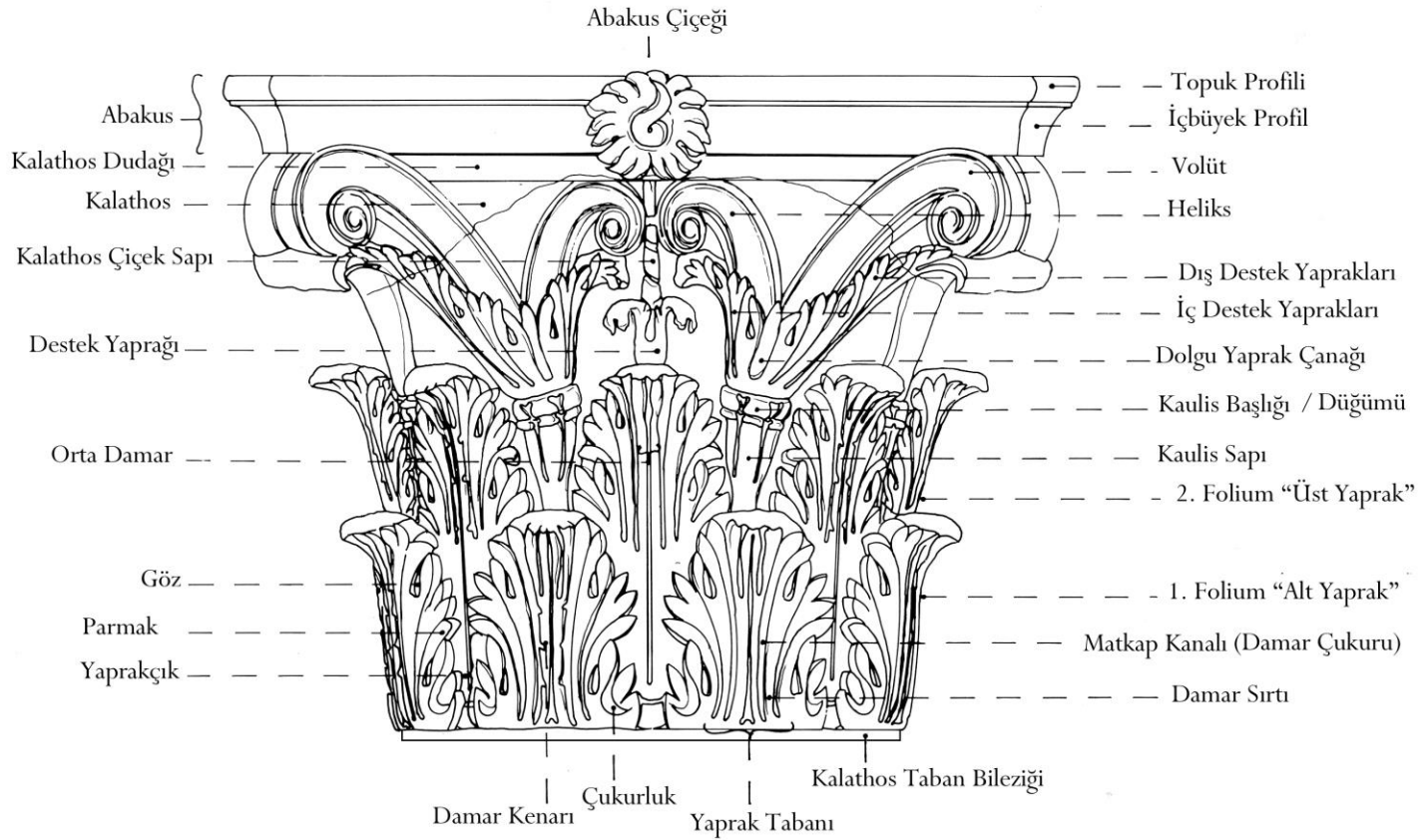

KOMPOZİT BAŞLIK

