





 Command girişi: ray ↵,

Multiline (Çoklu çizgi)

-  Modify Kayar menü: Multiline
-  Modify toolbar:
-  Command girişi: mline ↵, mL ↵

Polyline (Birleşik çizgi)

-  Modify Kayar menü:
Polyline Modify toolbar:
- 
-  Command girişi: pl ↵,

Specify start point: Specify a point (1)

Current line-width is <current>

Specify next point or [Arc/Close/Halfwidth/Length/Undo/Width]: Specify a point (2) or enter an option

Polygon (Çokgen)

-  Modify Kayar menü:
Polygon Modify toolbar:
- 
-  Command girişi: pl ↵,

Enter number of sides <current>: Enter a value between 3 and 1024 or press ENTER

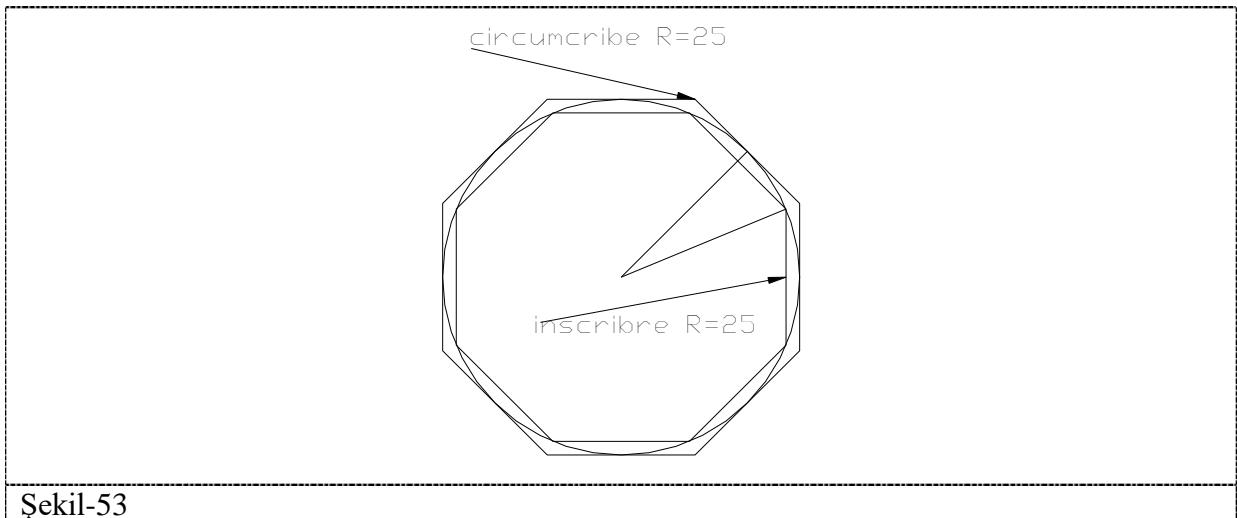

Specify center of polygon or [Edge]: Specify a point (1) or enter

ÖRNEKLER



Şekil-53

Rectangle (Dörtgen)

-  Modify Kayar menü:
Rectangle Modify toolbar:
- 
-  Command girişi: rec ↵,

Arc (Yay çizmek)



-  Modify Kayar menü:
Arc Modify toolbar:
- 
-  Command girişi: arc↵,

Specify start point of arc or [Center]:Specify a point, enter c, or press ENTER to start tangent to last line, arc, or polyline



Circle (Çember çizmek)

-  Modify Kayar menü:
Çember Modify toolbar:
- 
-  Command girişi: circle↵, c↵

Donut (Dolu çember çizmek)

-  Modify Kayar menü: donut
-  Modify toolbar:
-  Command girişi: donut↵,

Spline (esnek birleşik çizgi)

-  Modify Kayar menü:
spline Modify toolbar:
- 
-  Command girişi: spline↵,

Elipse (Elips)

-  Modify Kayar menü: elips

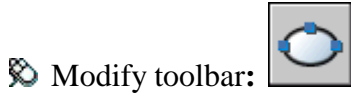

Modify toolbar:

Command girişi: elipse.↓, el.↓,

ÖRNEKLER

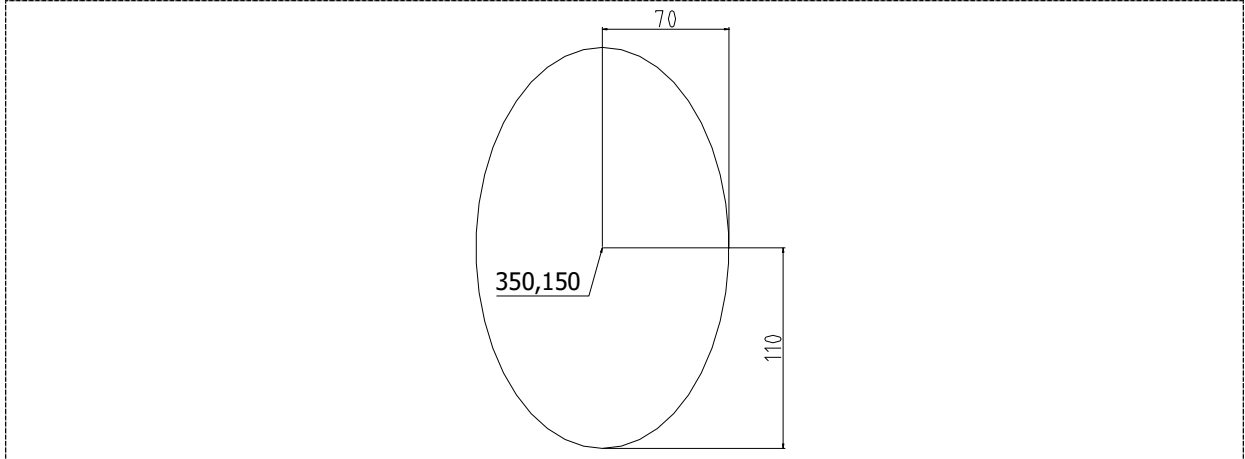

Şekil-54

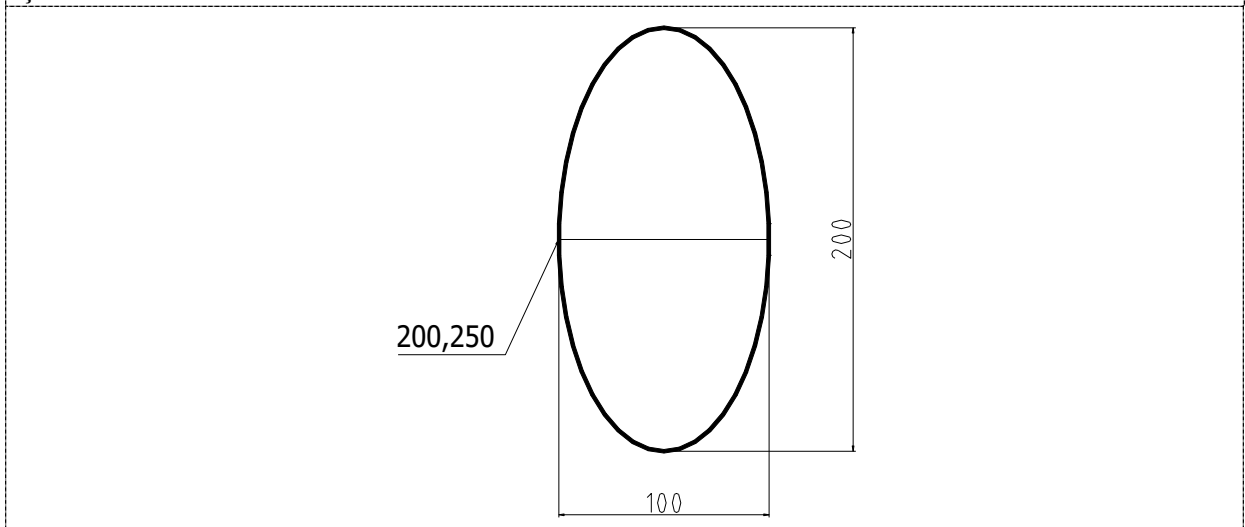

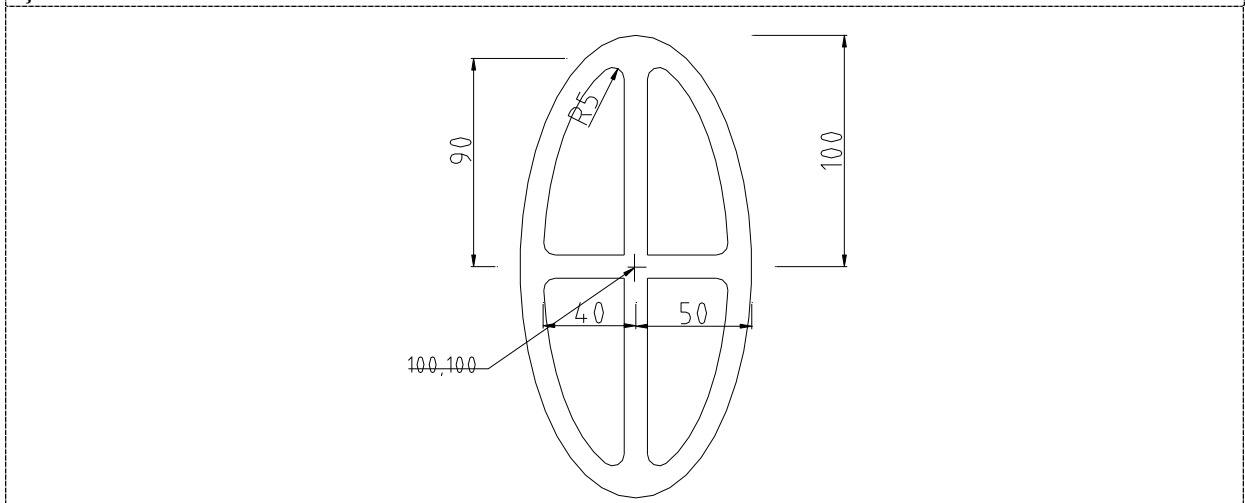

Şekil-55



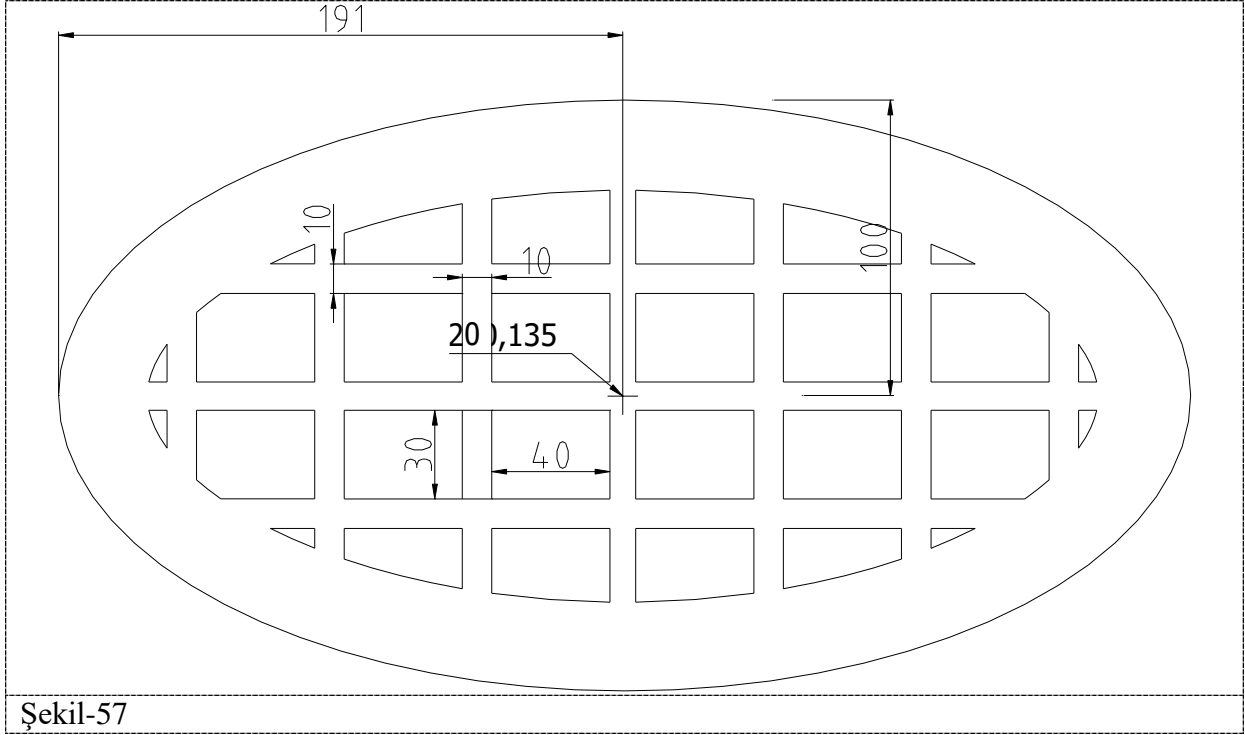

Şekil-56





Block (Blok yap)

-  Modify Kayar menü: block
-  make Modify toolbar:
-  Command girişi: block↵,

Point (Nokta)

-  Modify Kayar menü: **Point** Modify
-  toolbar:
-  Command girişi: point↵, po ↵

Hatch (Tarama)

-  Modify Kayar menü: **hatch** Modify
-  toolbar:
-  Command girişi: hatch↵