

# B Hücre Antijen Reseptörü (BCR)

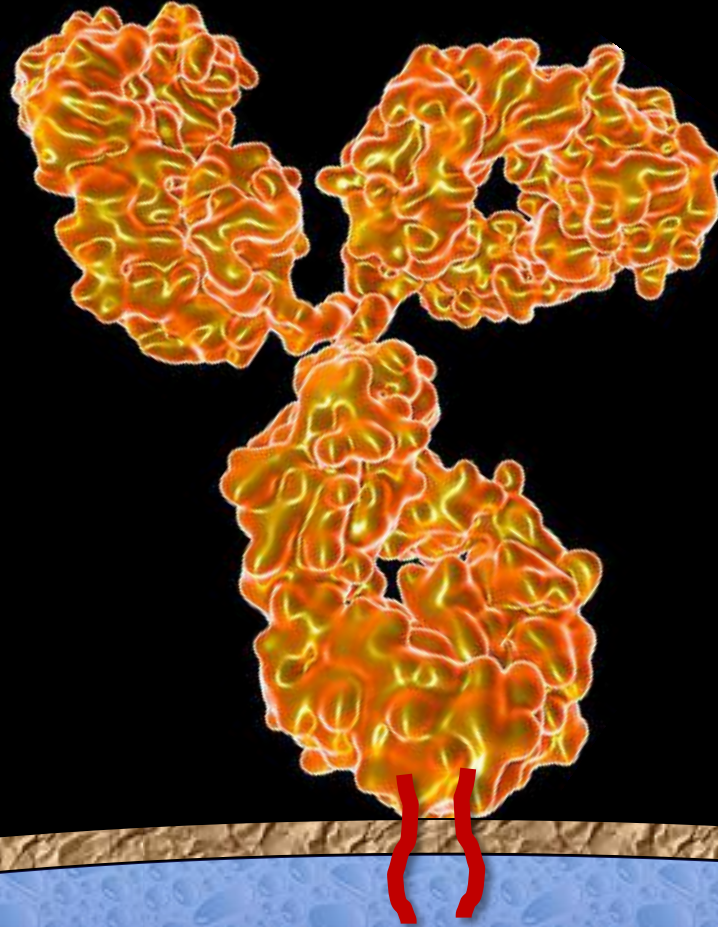

B hücresi

# B Hücre Antijen Reseptörleri (BCR)

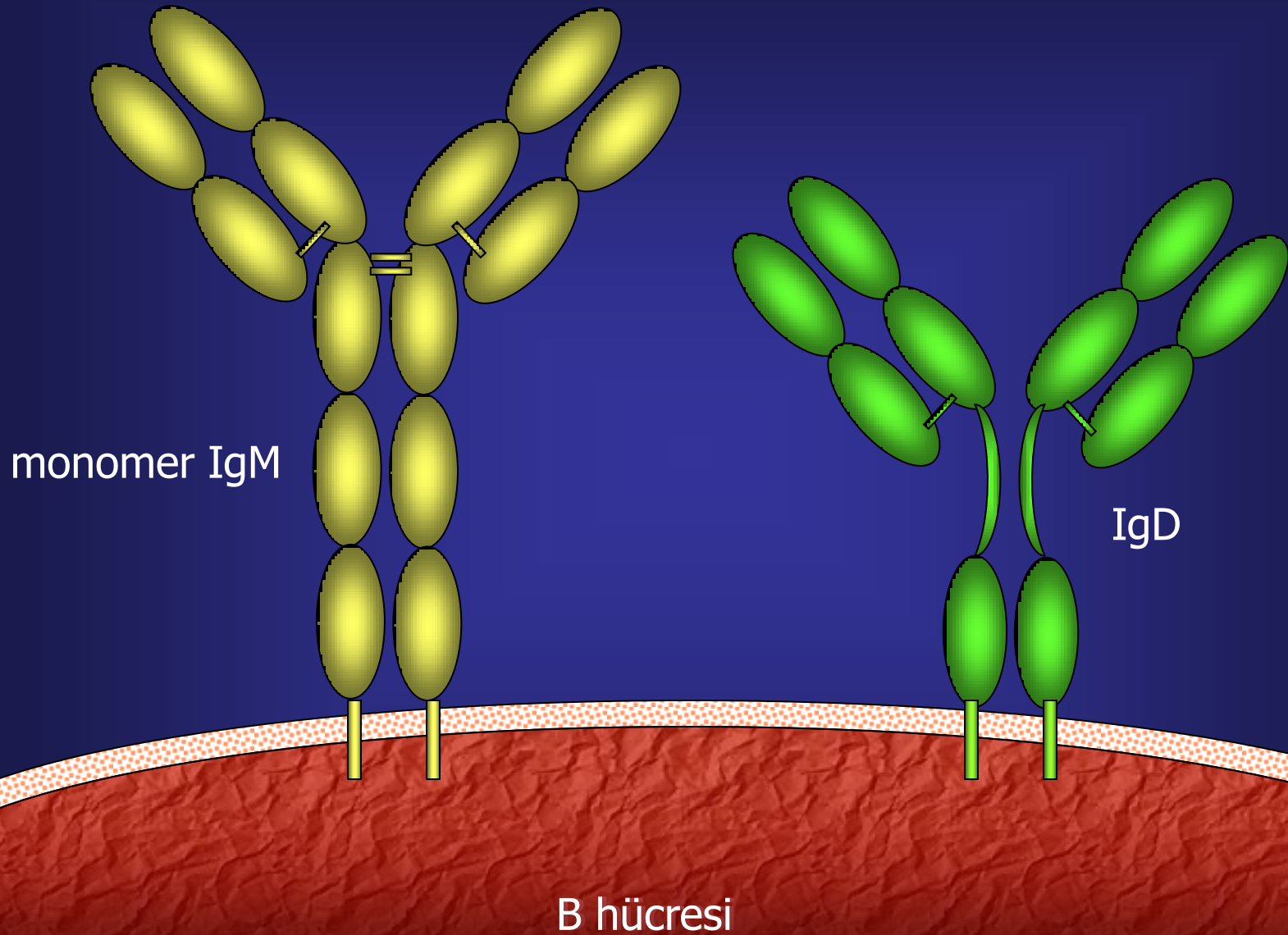

# B Hücree Antijen Reseptörü (BCR)

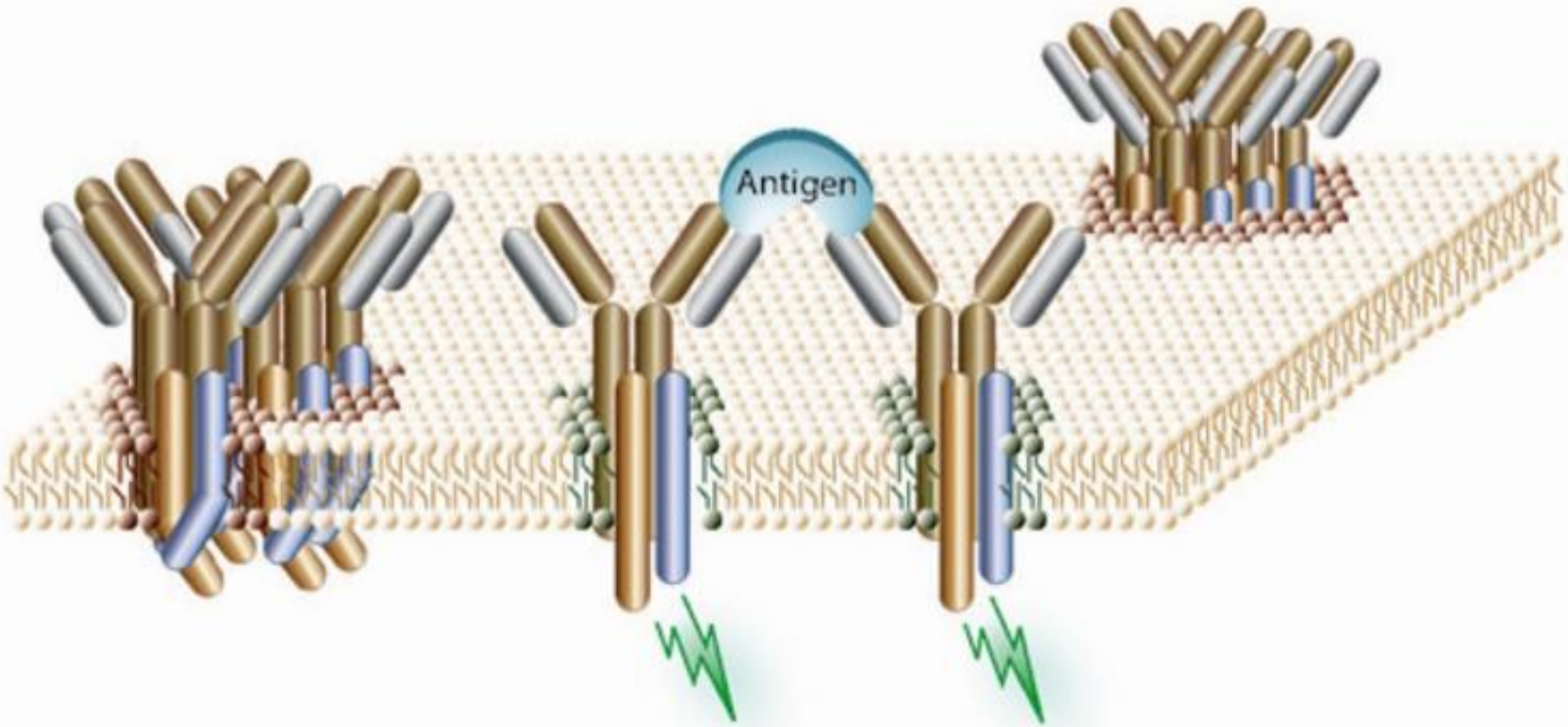

# B Hücre Reseptörü ve B Hücre Reseptör Kompleksi

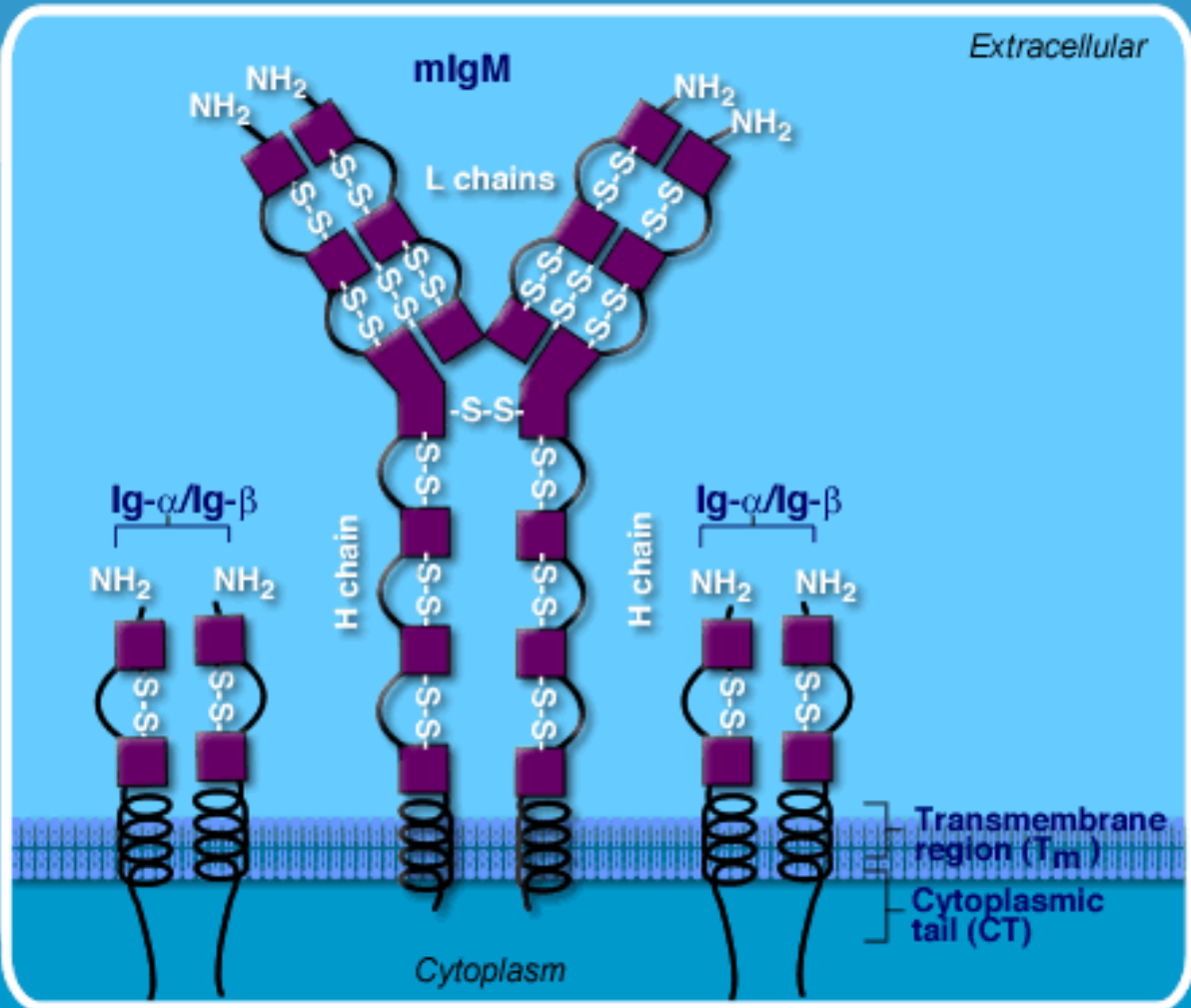
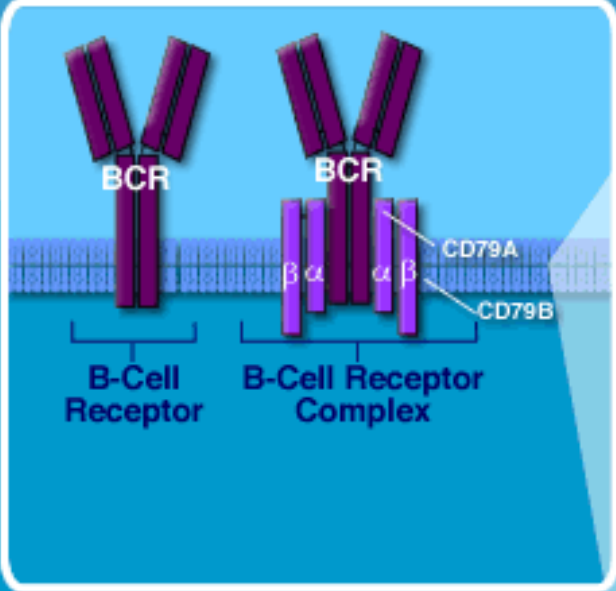

# B Hücre Reseptör Kompleksi ve Ek Sinyal Sistemi

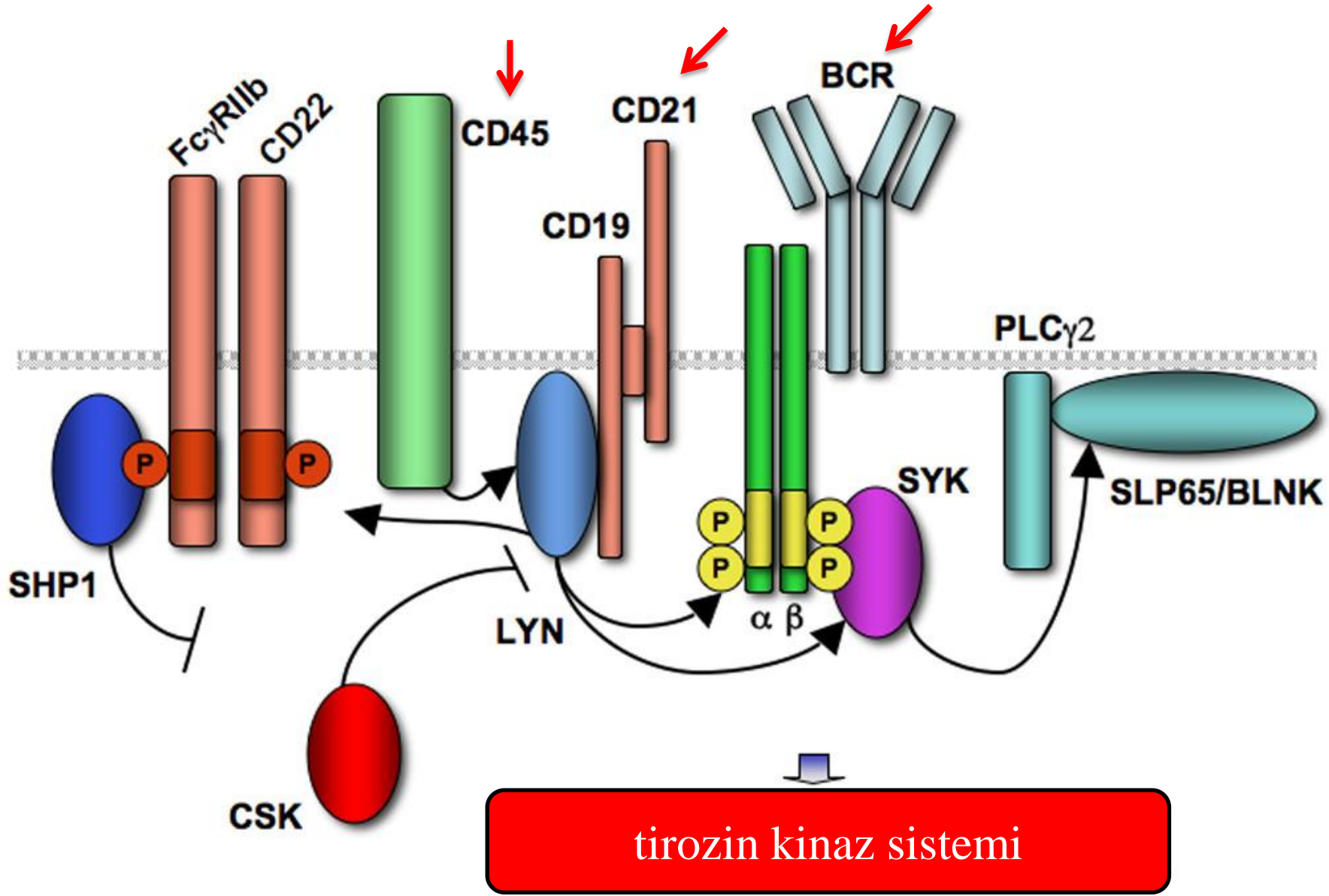

# B Hücre Reseptör Kompleksi ve Ek Sinyal Sistemi

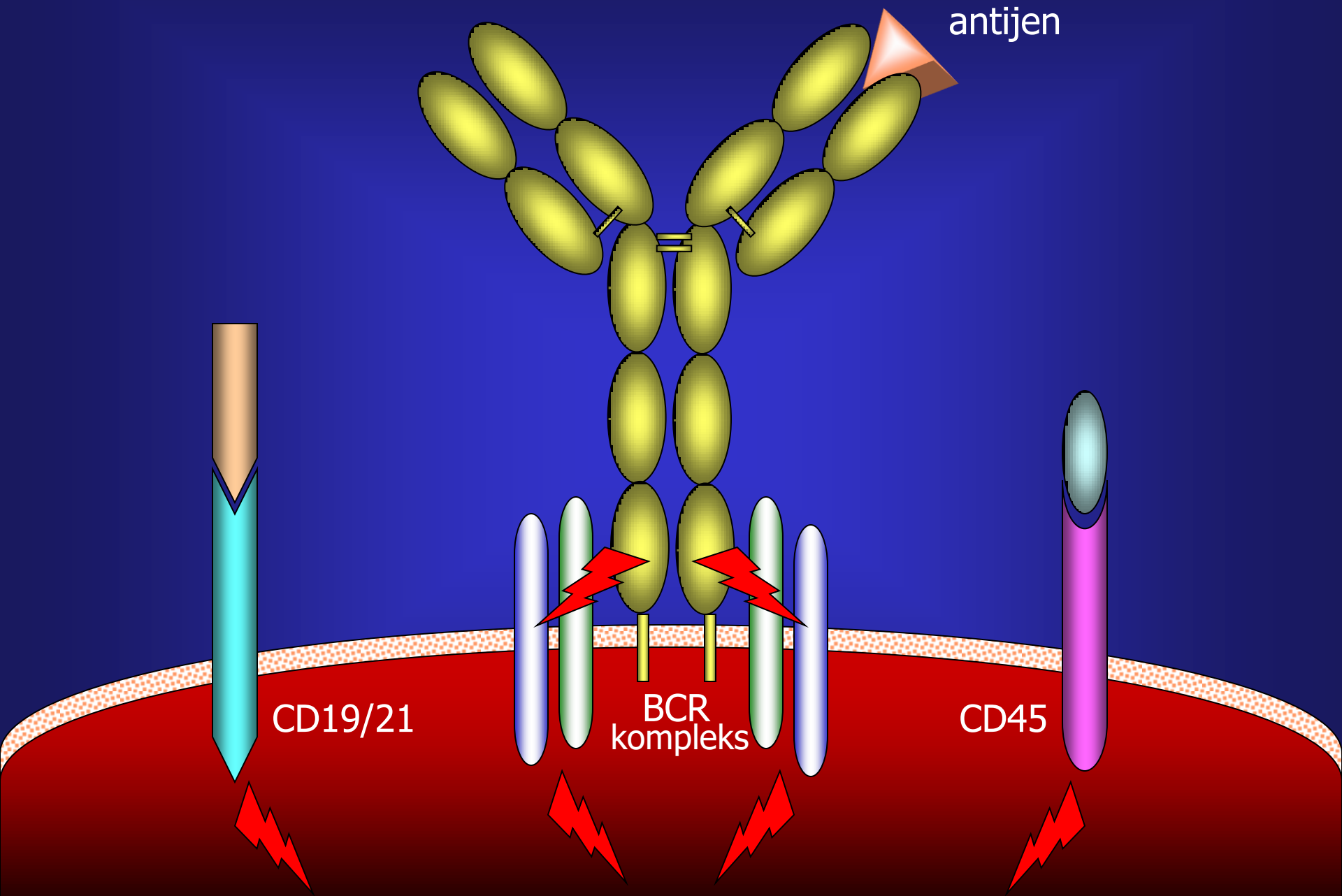

# B Hücre Reseptör Kompleksi ve Ek Sinyal Sistemi

aktivasyon

inhibisyon

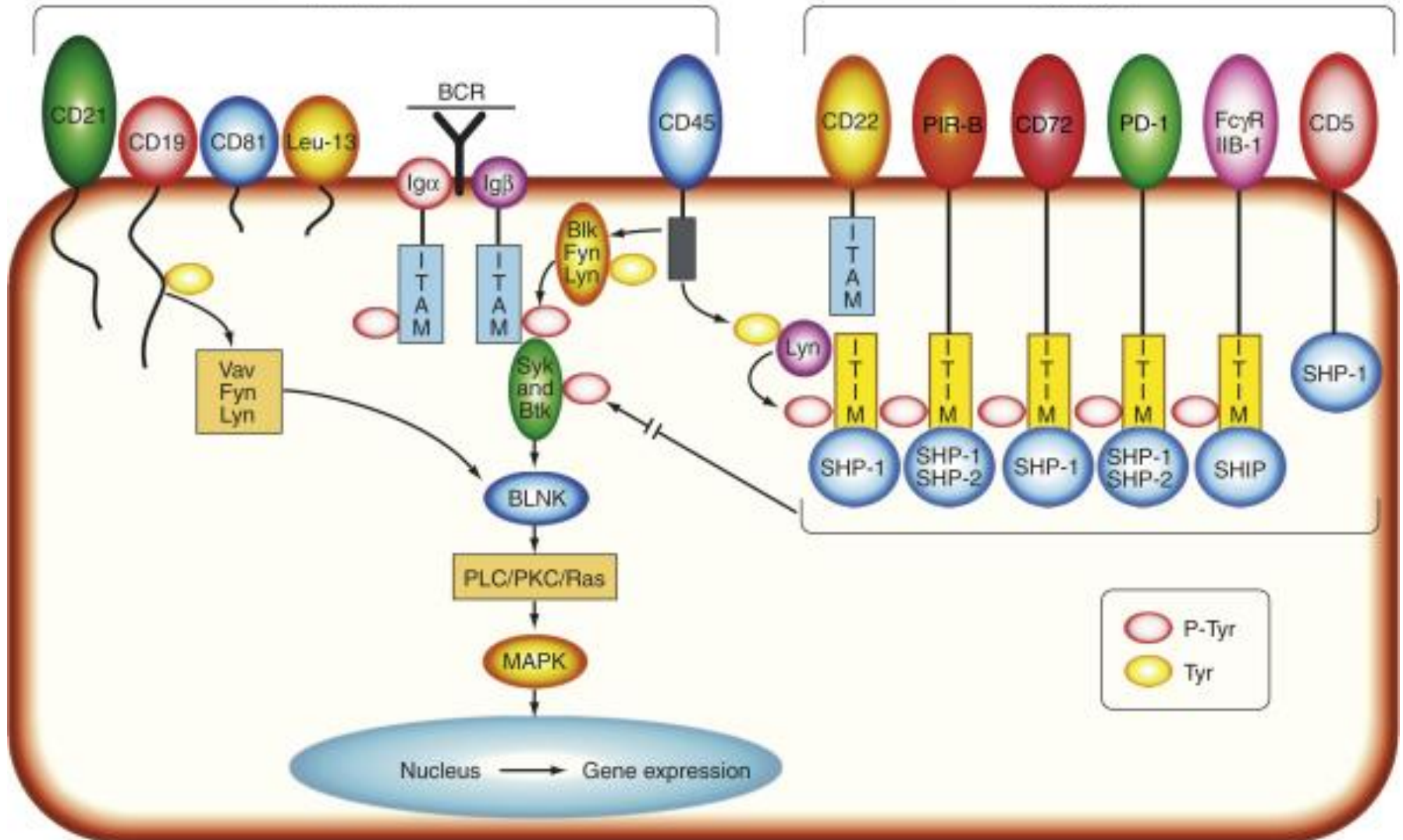

# BCR Uyarımı ve Kontrol Aşamaları

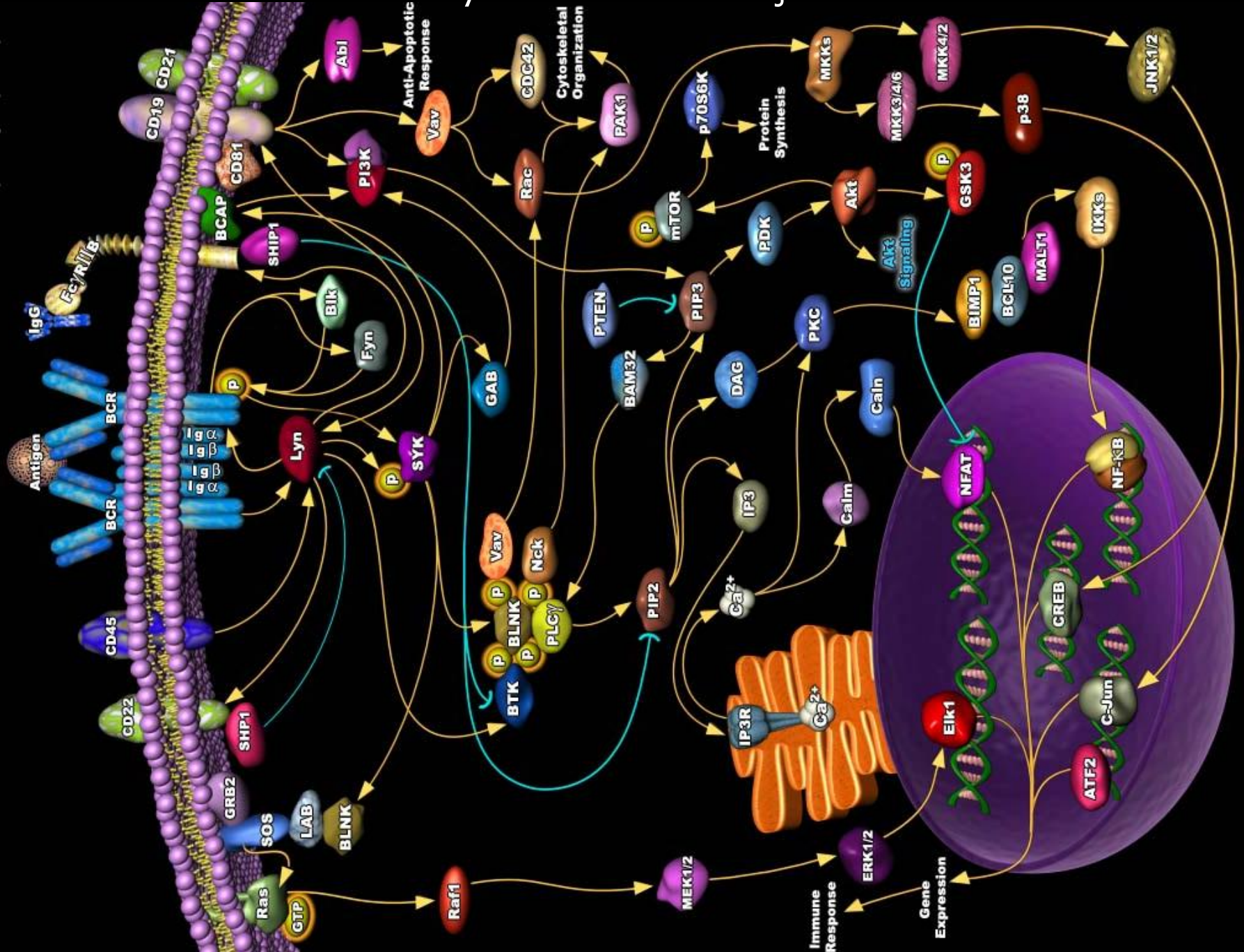



# B Hücre Uyarım ve Kontrol Aşamaları

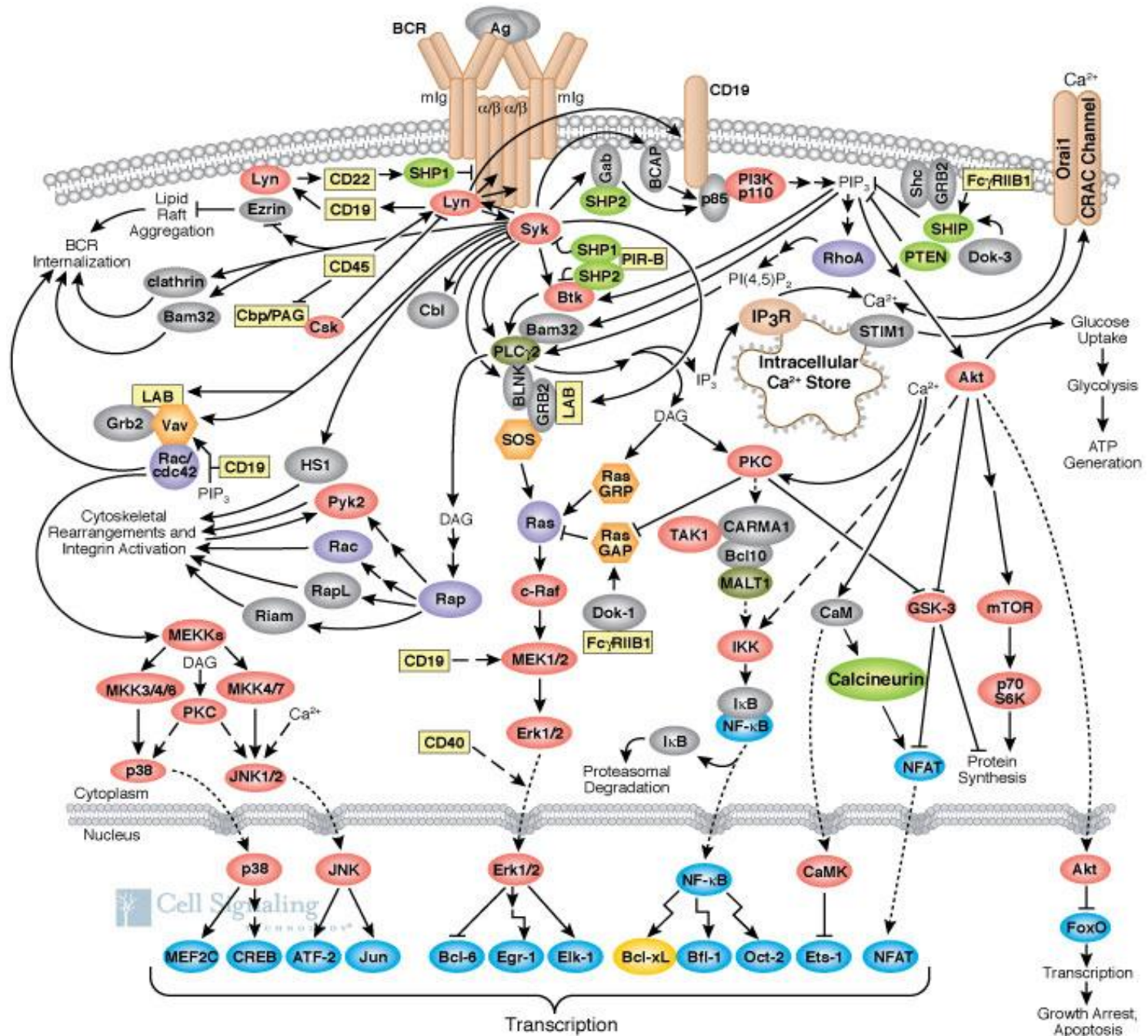

# Fc reseptörü (FCR)

Hücre

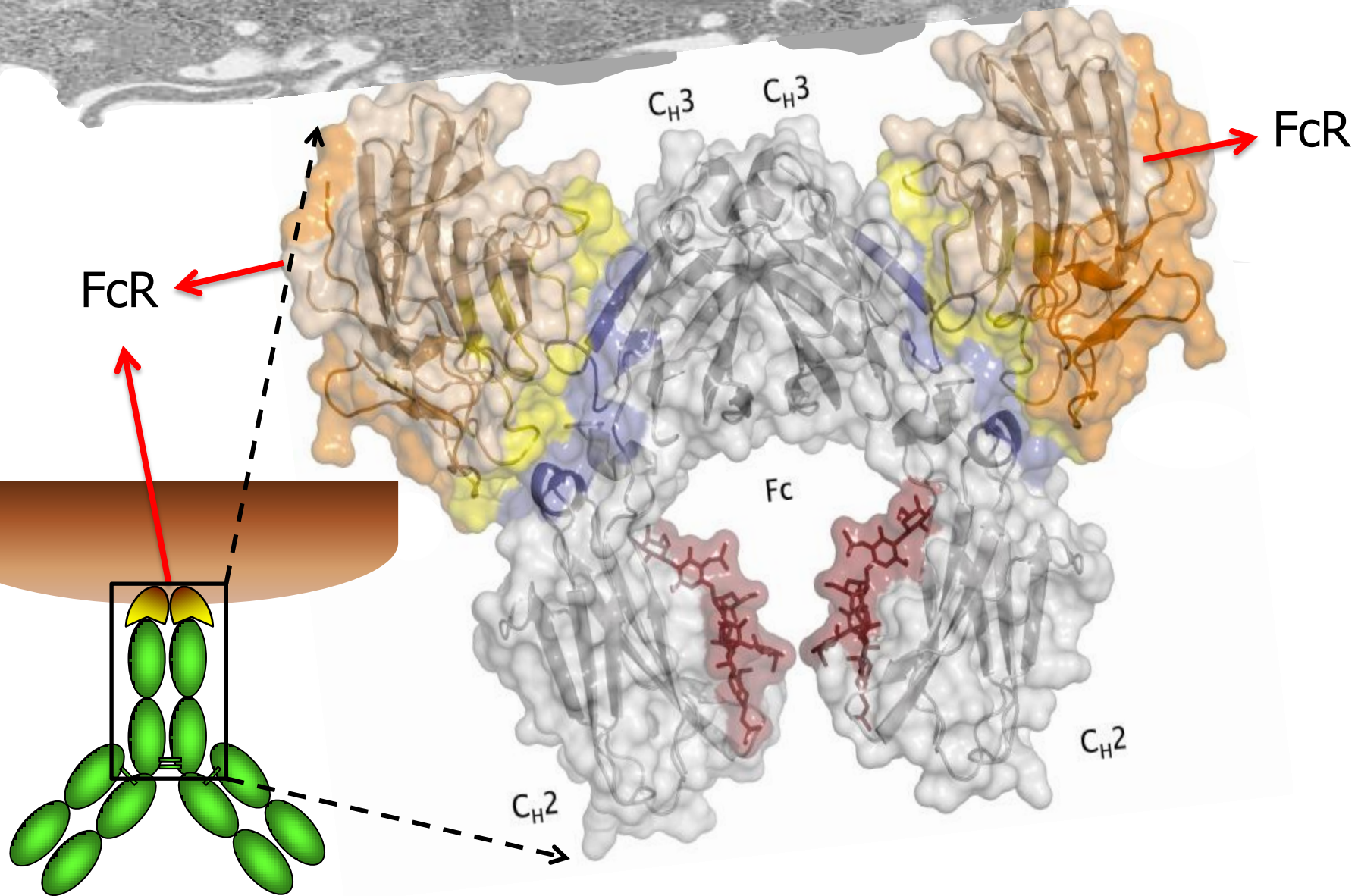

# T Hücre Antijen Reseptörü (TCR)

$\alpha$  zinciri

$\beta$  zinciri



çok değişken bölgeler

değişken bölge

sabit bölge



- \*ilmek bölgeleri
- \*disülfid bağları
- \*N-ucu/C-ucu

T hücresi

# İmmunglobulin Süperfamilyası Molekülleri

## The Immunoglobulin Superfamily

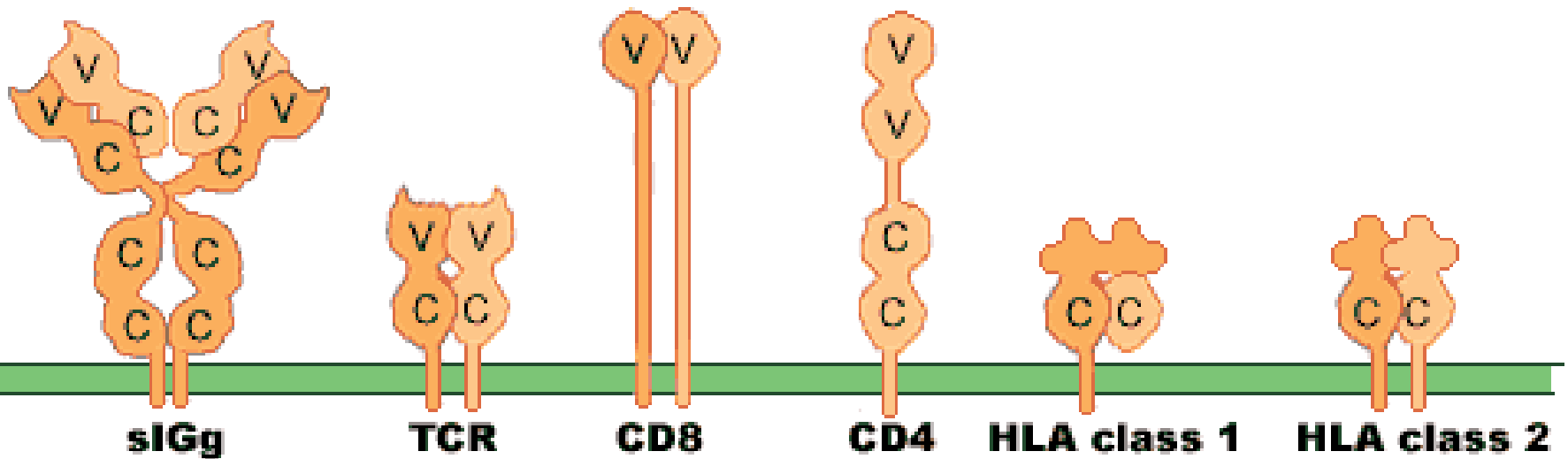

# T Hücre Antijen Reseptörü (TCR)

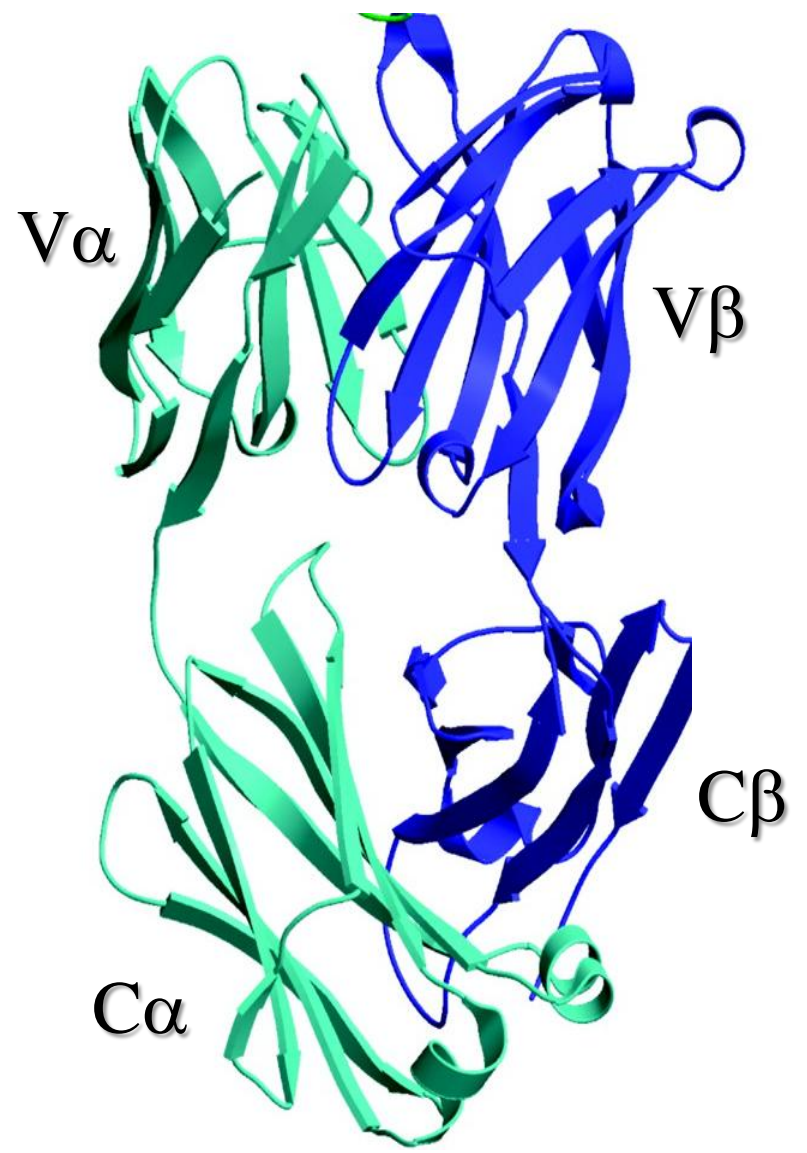
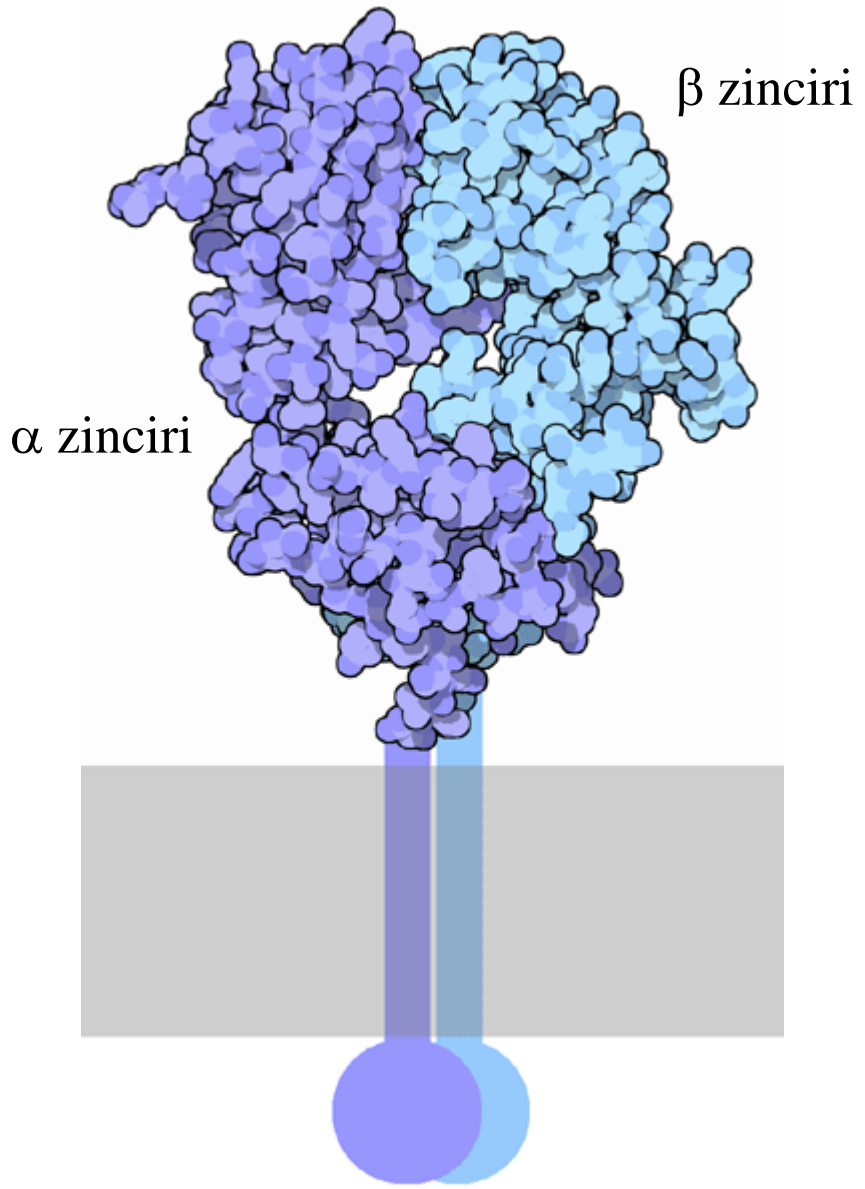

# T Hücre Antijen Reseptörü (TCR)

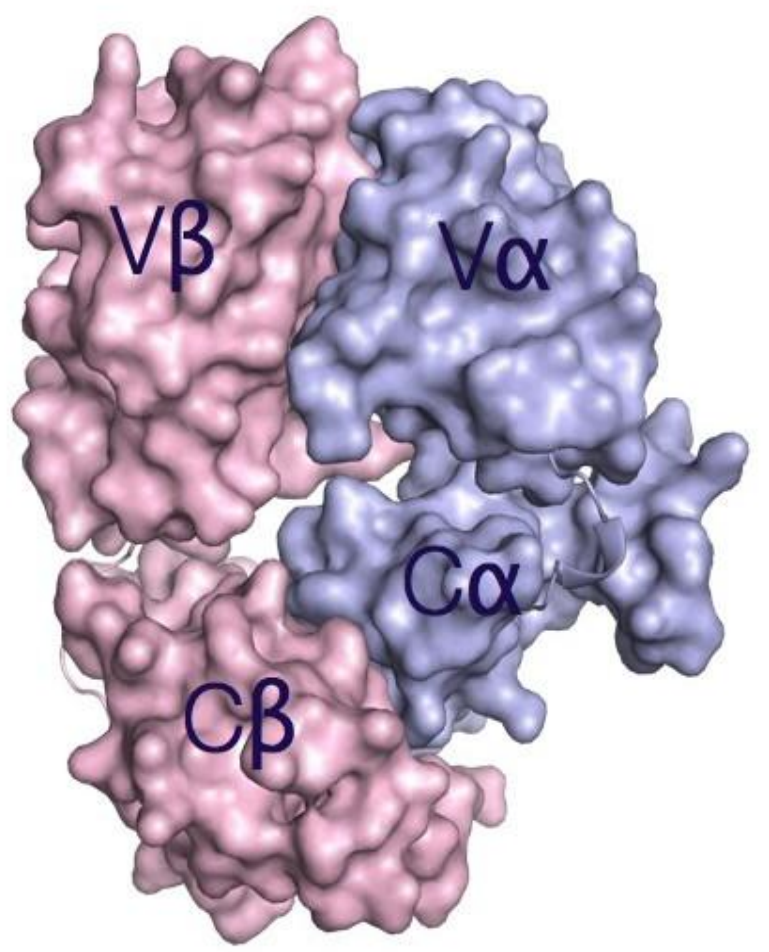
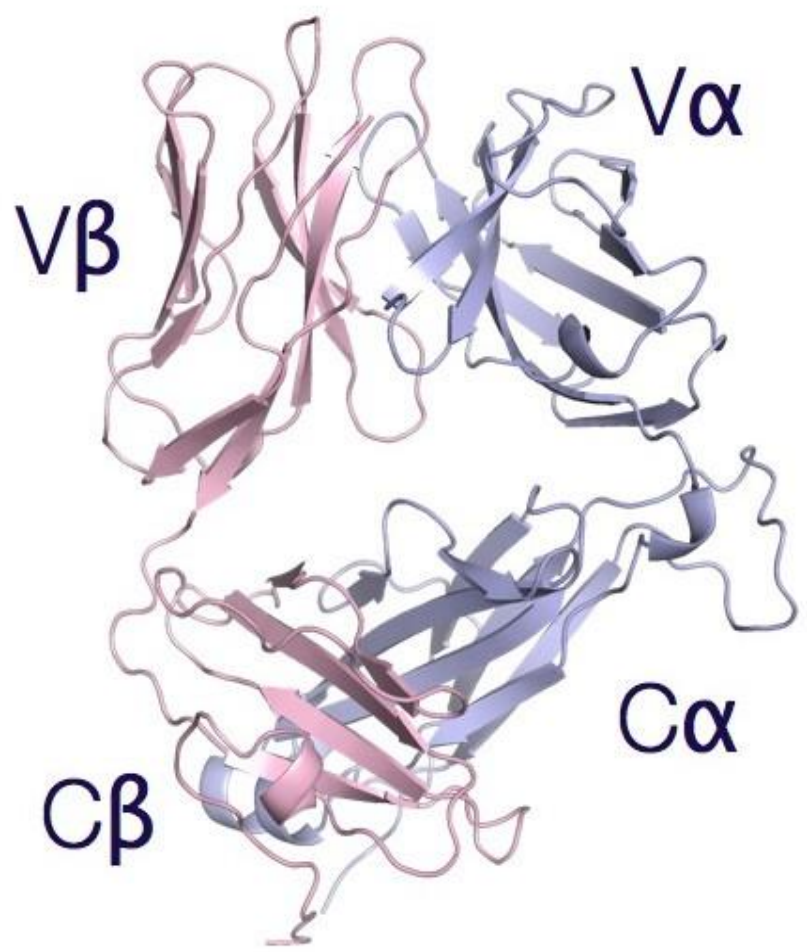

# T Hücre Antijen Reseptör Kompleksi

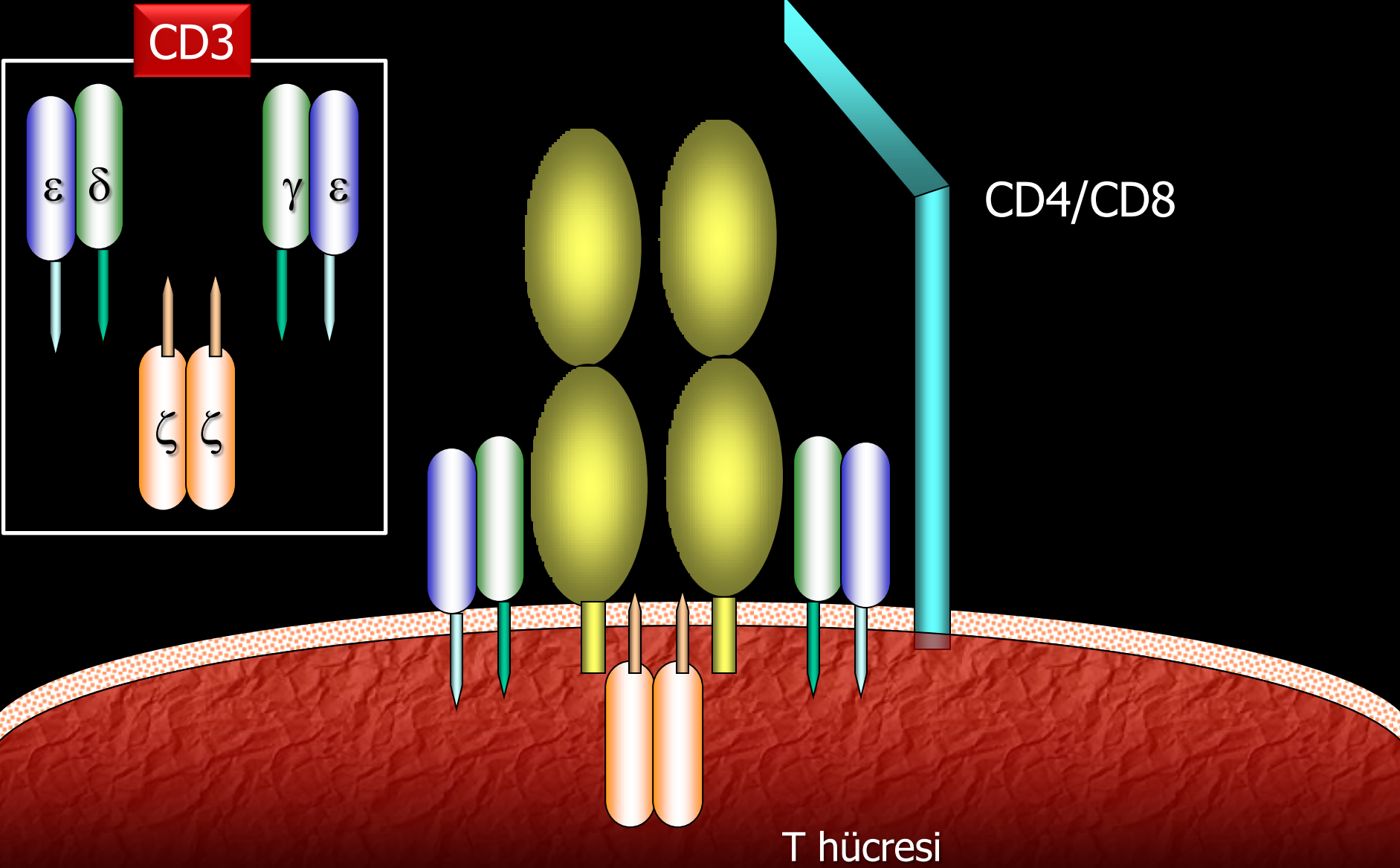

antijen sunan hücre

MHC-antijen

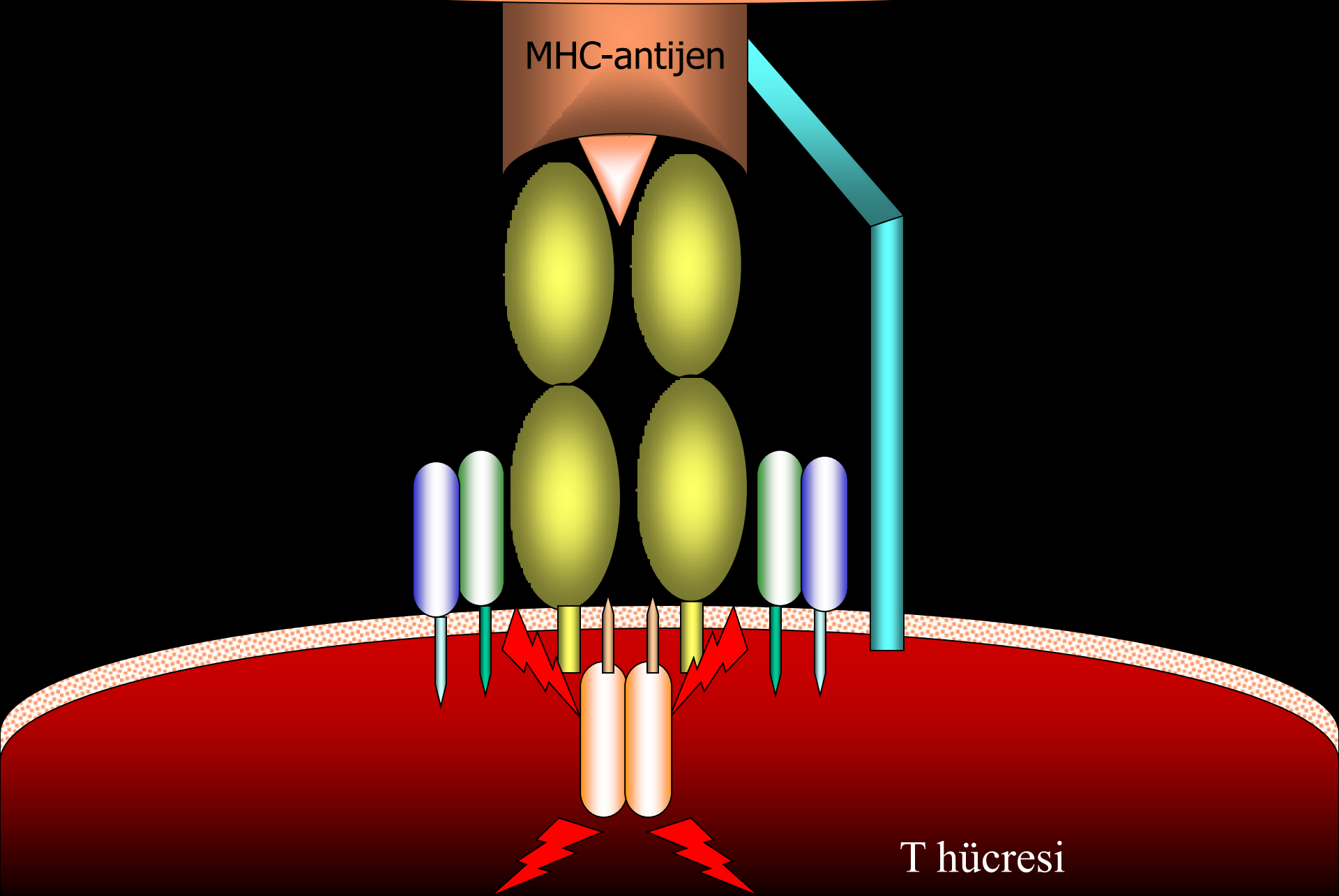

T hücresi



# TCR/CD4/CD8-MHC Bağlantısı

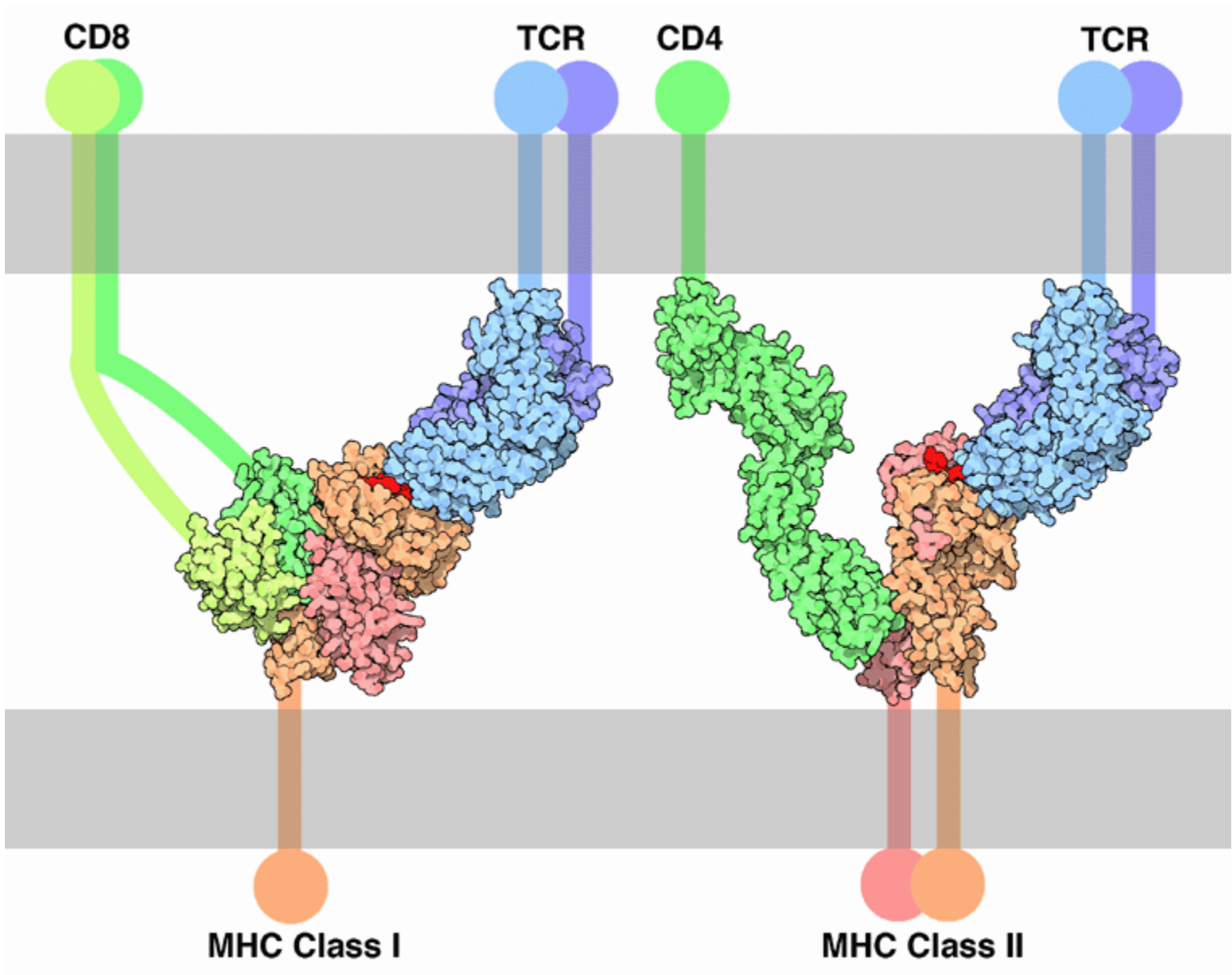

# TCR-MHC Bağlantısı

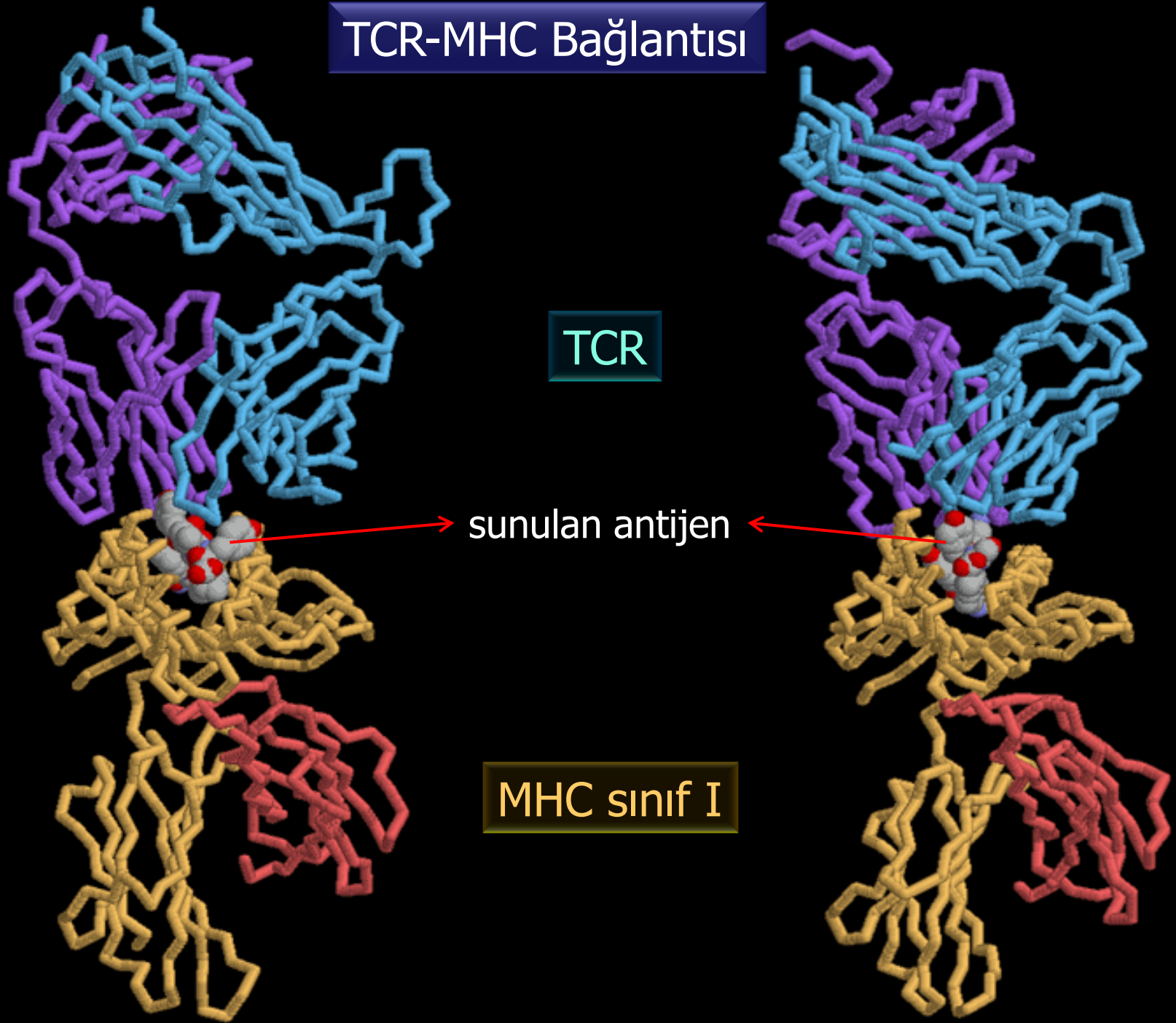

TCR

sunulan antijen

MHC sınıf I

# TCR-MHC Bağlantısı

TCR

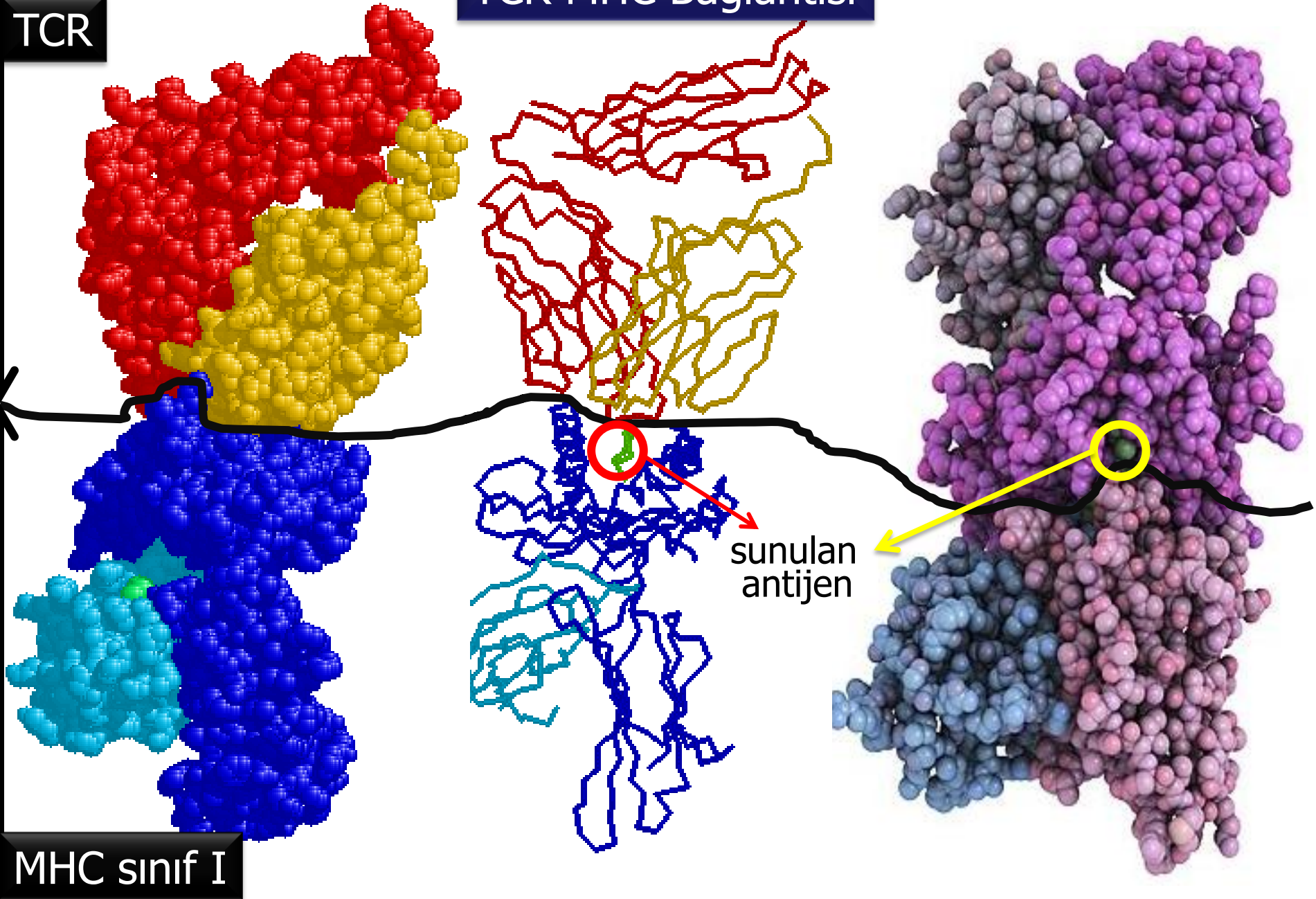

MHC sınıf I

sunulan antijen

sunulan antijen

TCR

TCR-MHC Bağlantısı

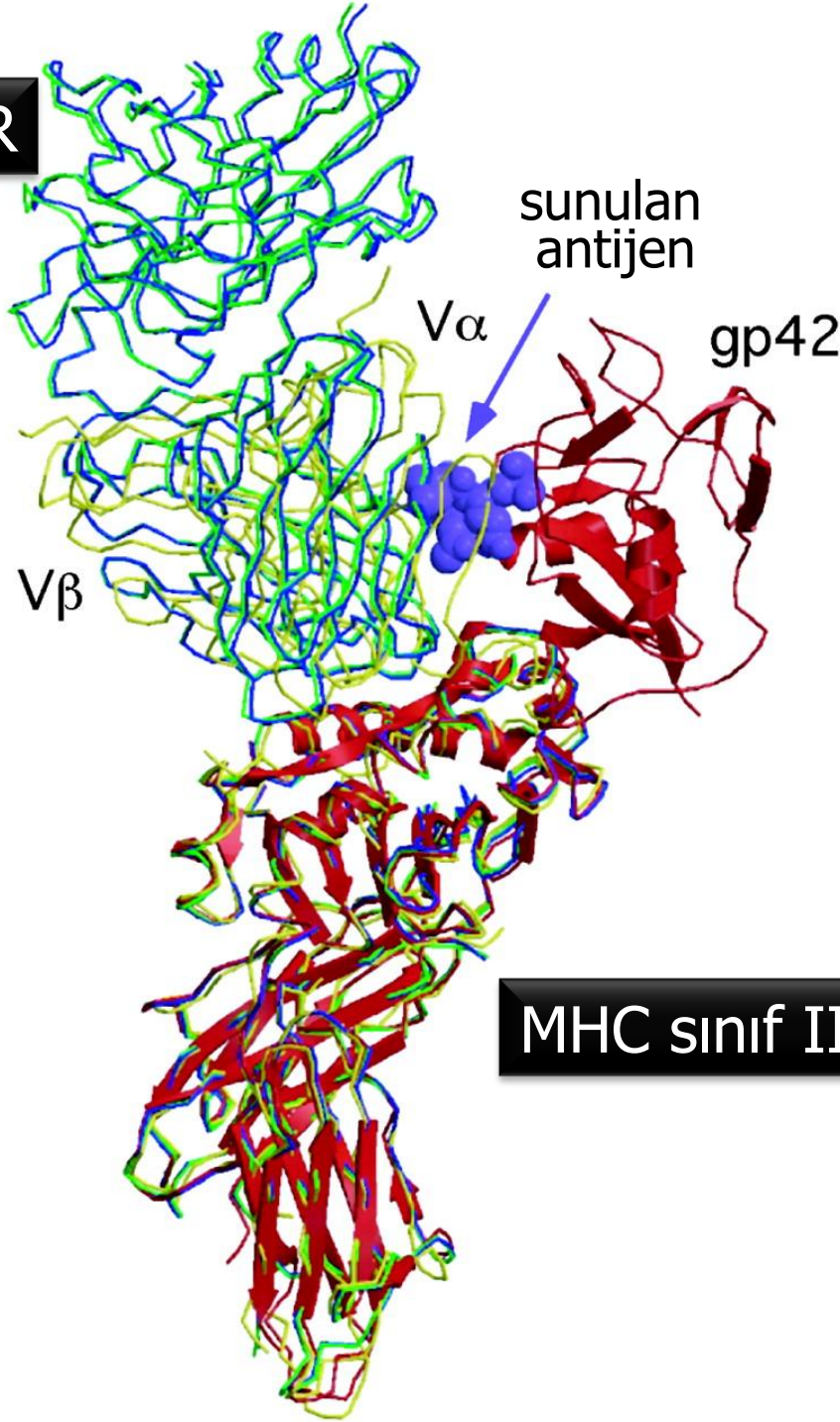

# TCR Uyarımı ve Kontrol Aşamaları

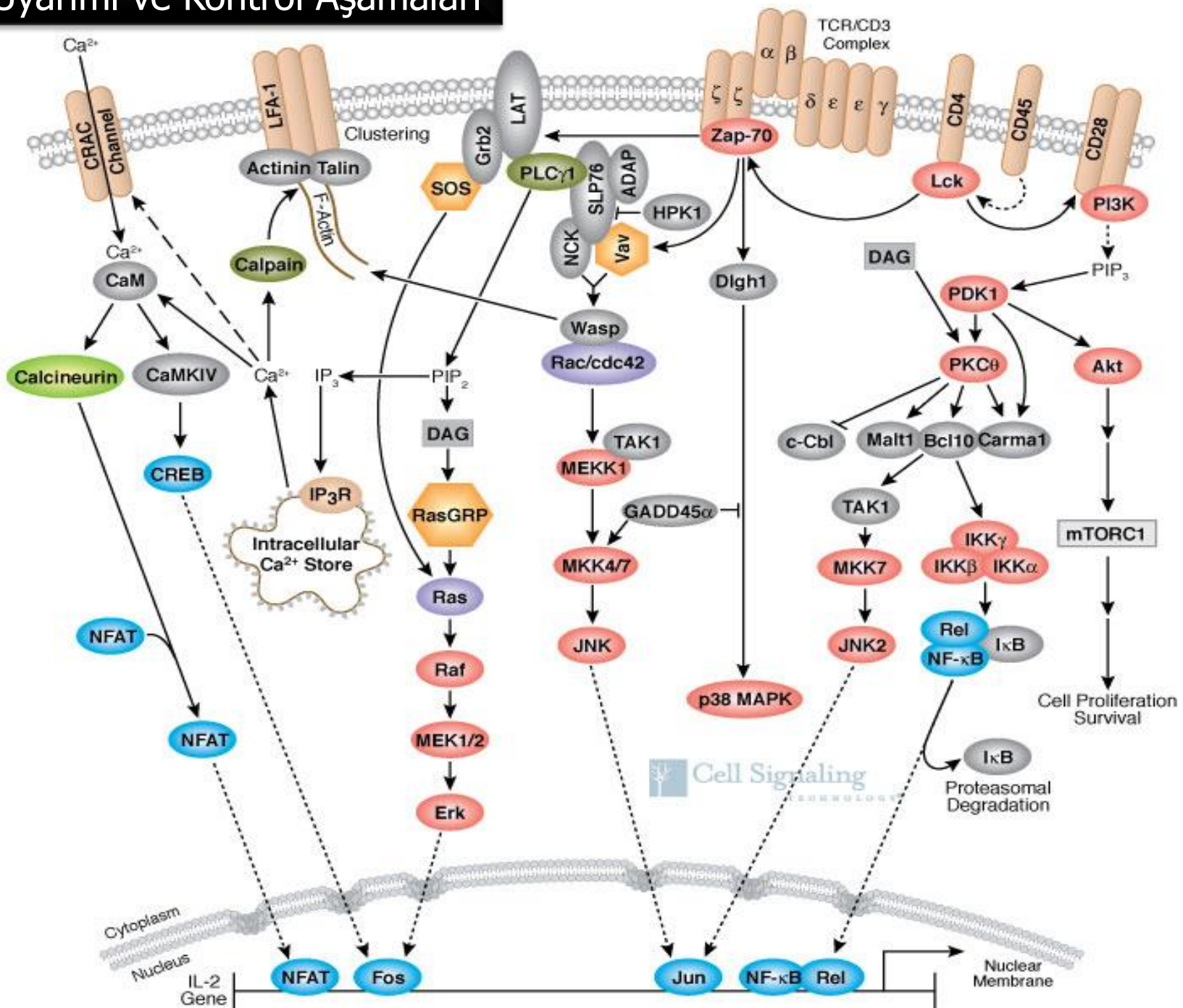

## T hücre Uyarımı ve Kontrol Molekülleri

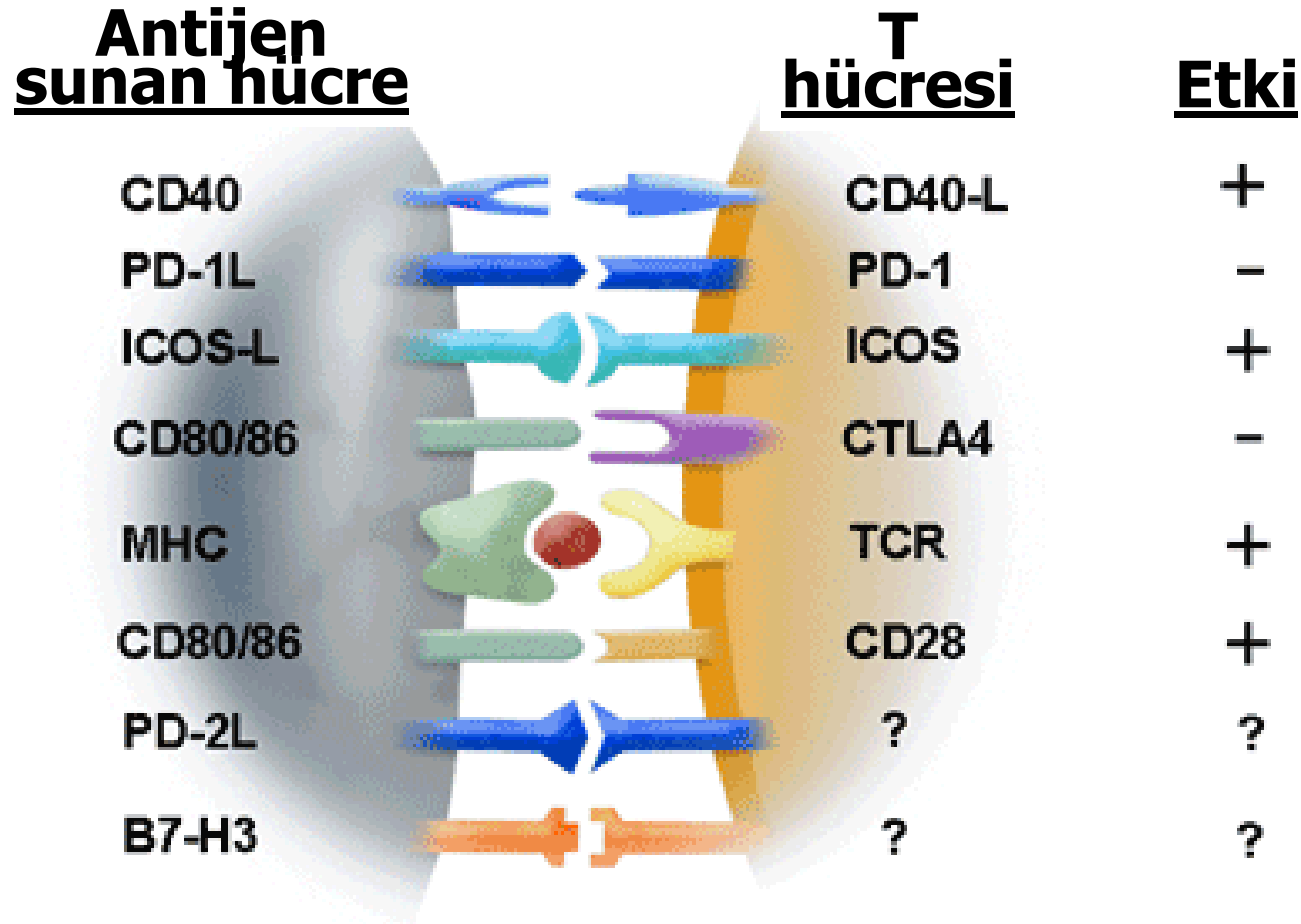

# İmmun Sistemde Makromoleküler Bağlar



- Antijen-Antikor
- Antijen-BCR
- MHC-TCR
- MHC-CD4/CD8
- Sitokin-Reseptör
- Sinyal molekülü-Reseptör
- Adhezyon molekülü-Reseptör
- FcR-Antikor

**Nonkovalent Bağlar**

# Nonkovalent Bağlar

elektron bulutu

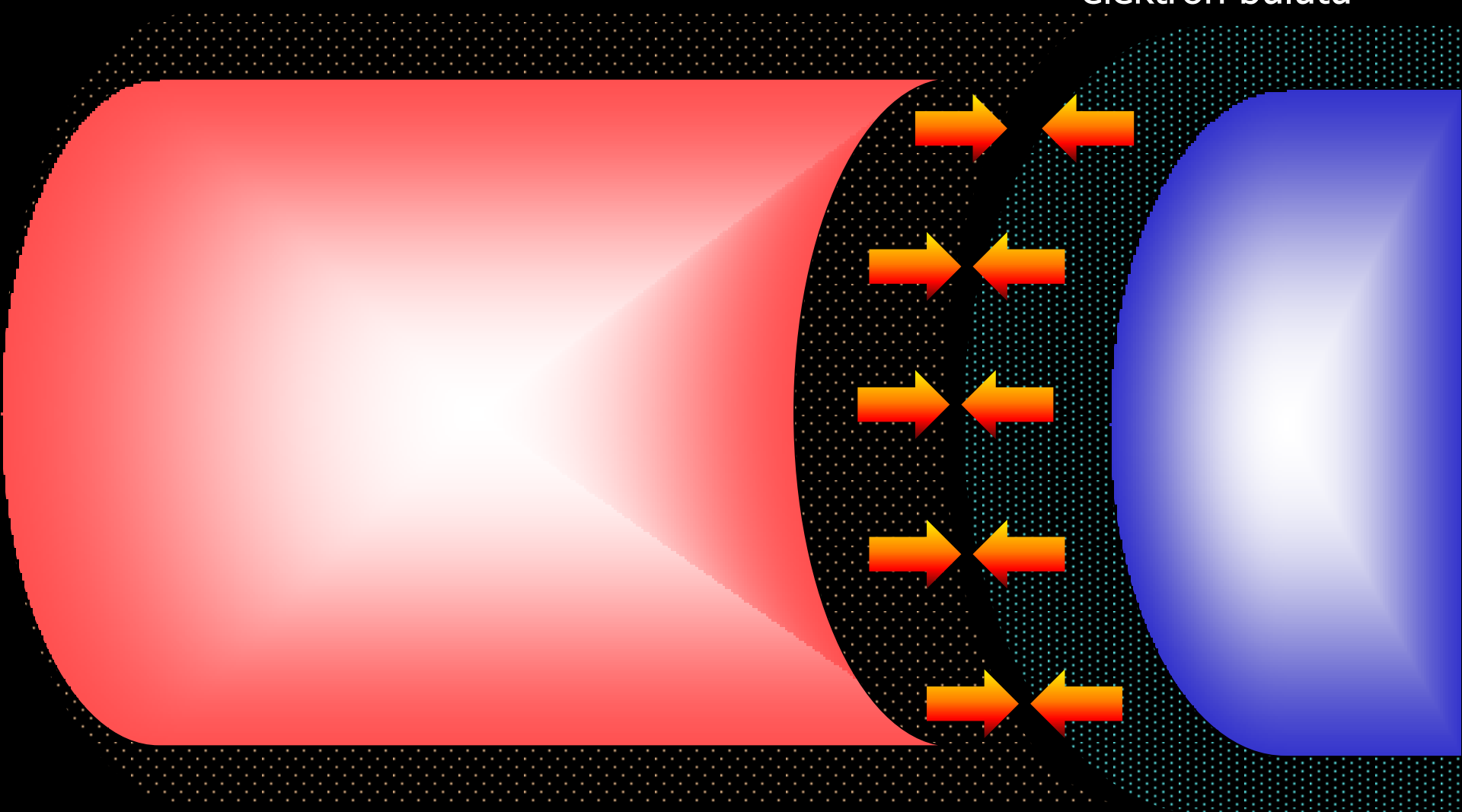

elektron bulutu



## Nonkovalent Baęlar

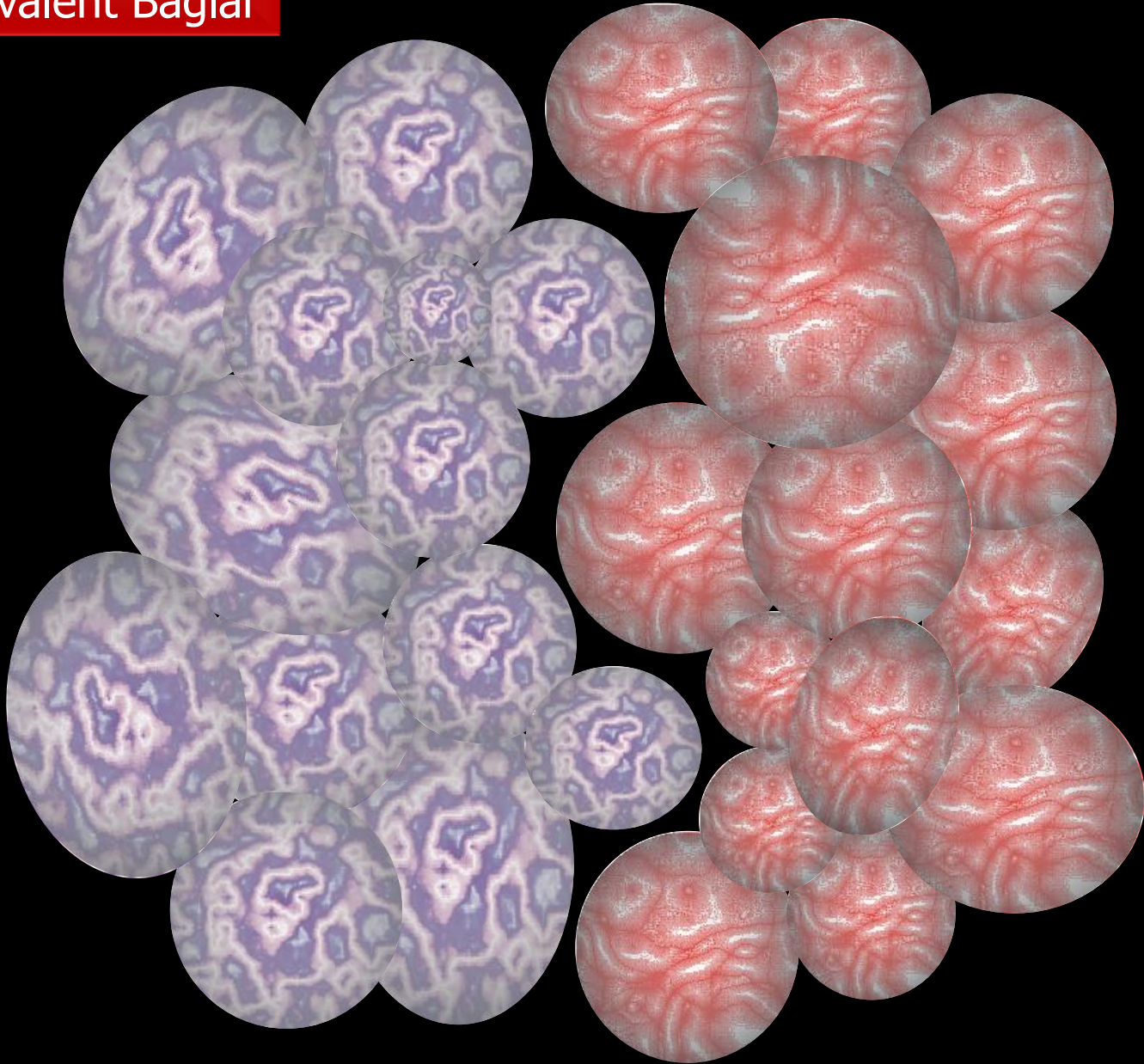

Temas yüzeyinin uyumu – Yüzey topografisinin uyumu

# Nonkovalent Baęlar

Temas yüzeyinin uyumu

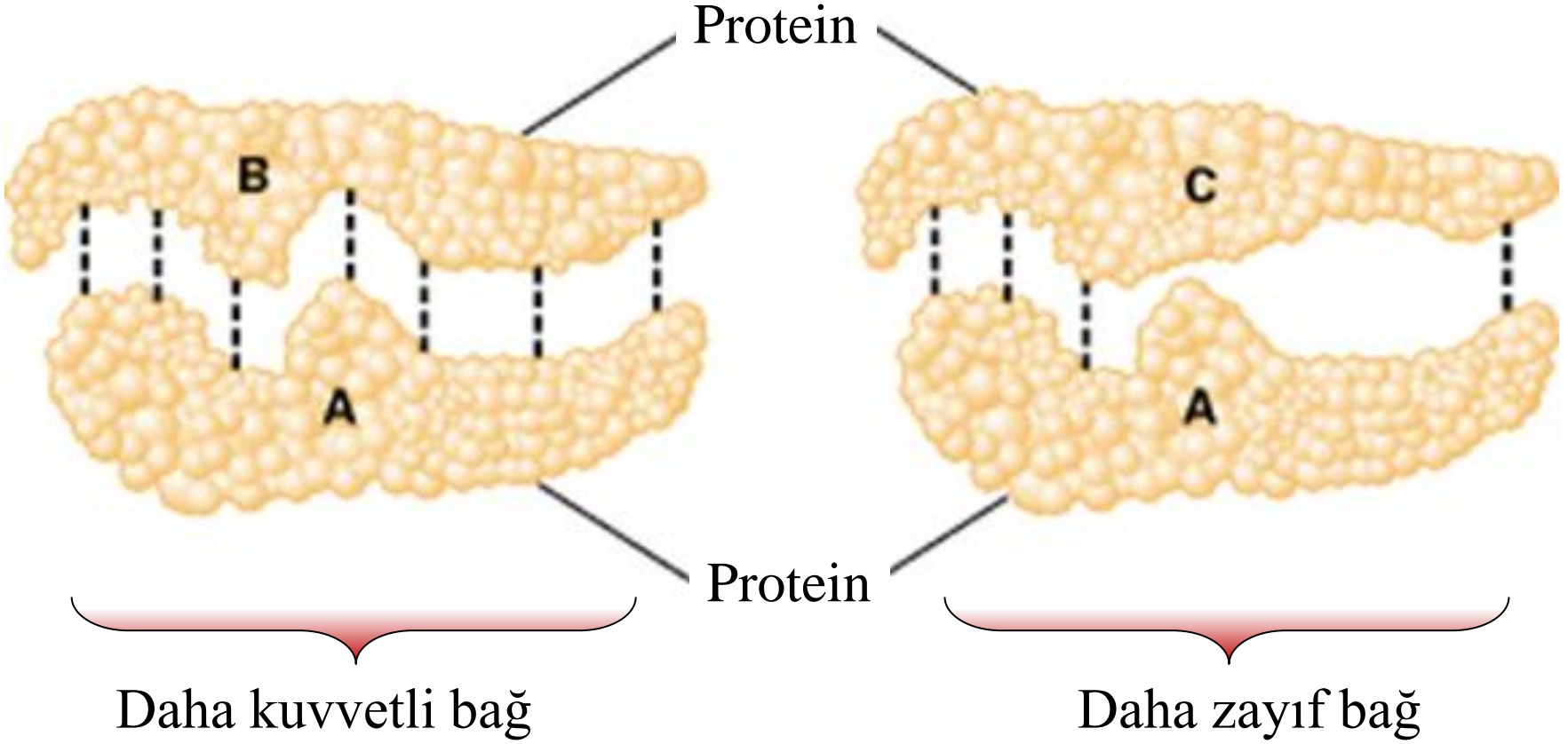

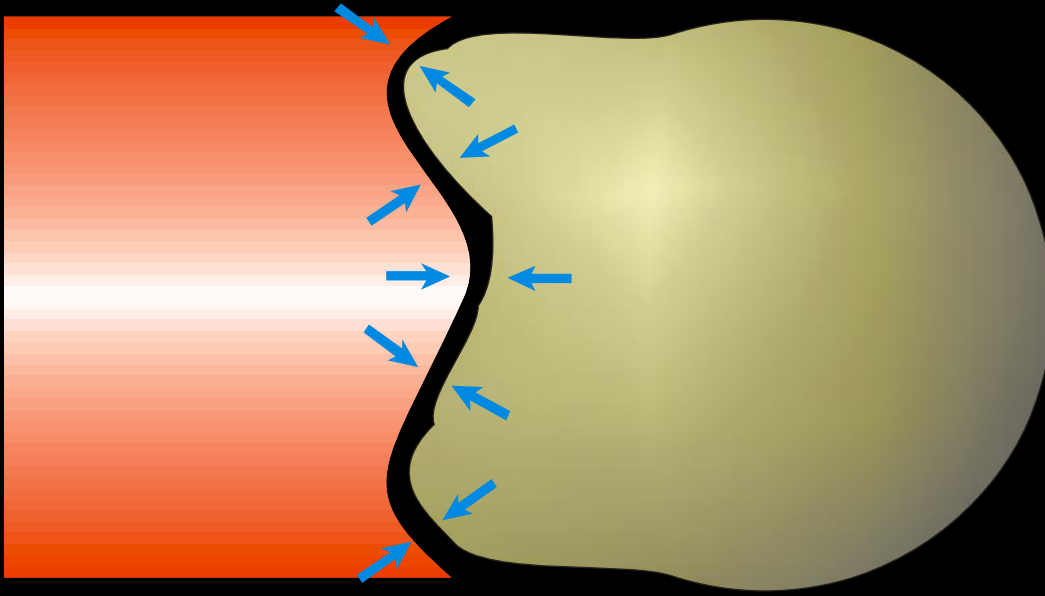

Daha kuvvetli bađ

Nonkovalent Bađlar

Temas yüzeyinin uyumu

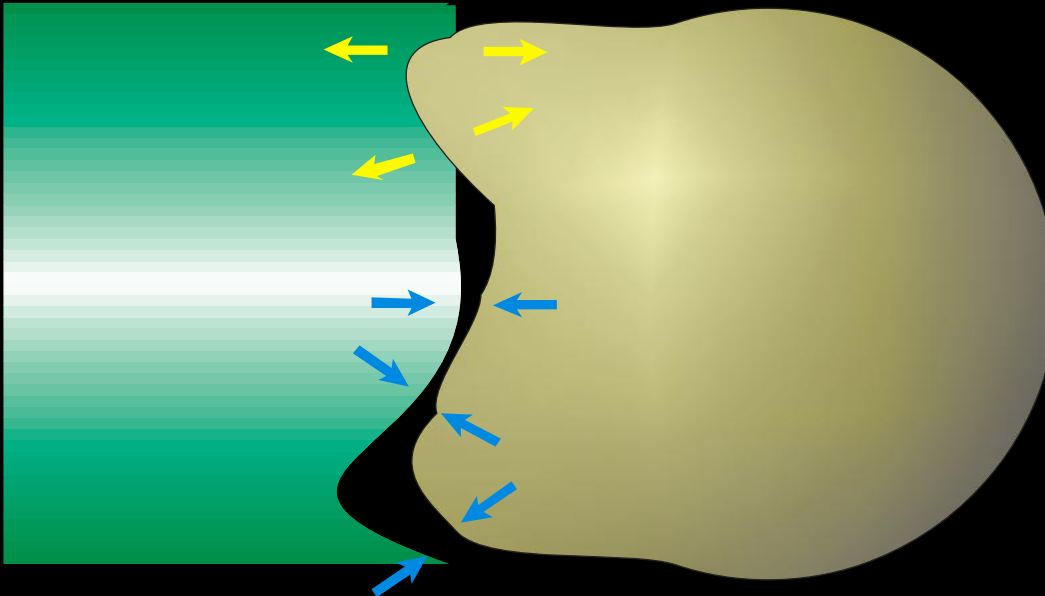

Daha zayıf bađ

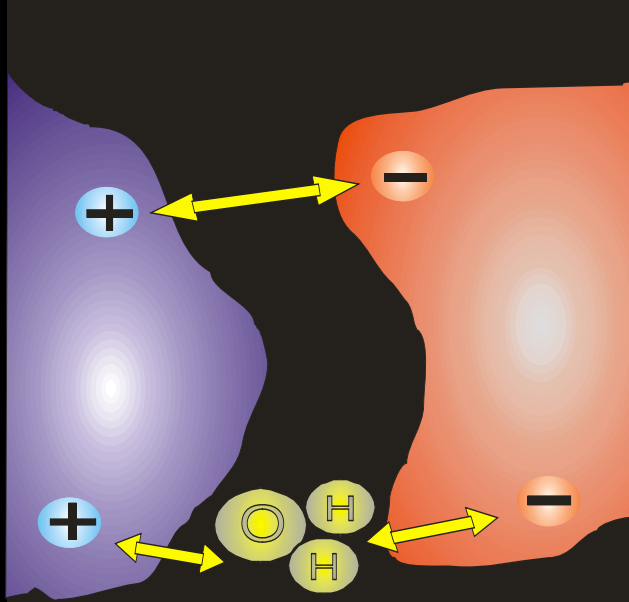

İyonik bağ

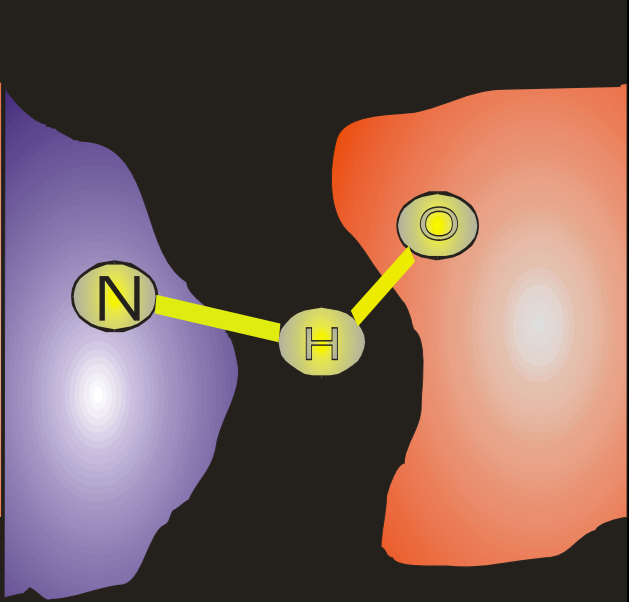

Hidrojen bağı

Nonkovalent Bağlar

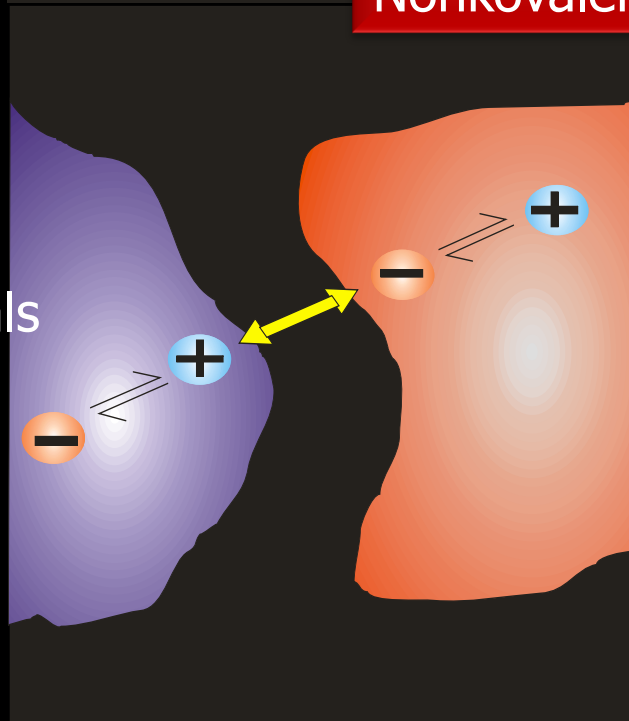

VanDerWaals bağı

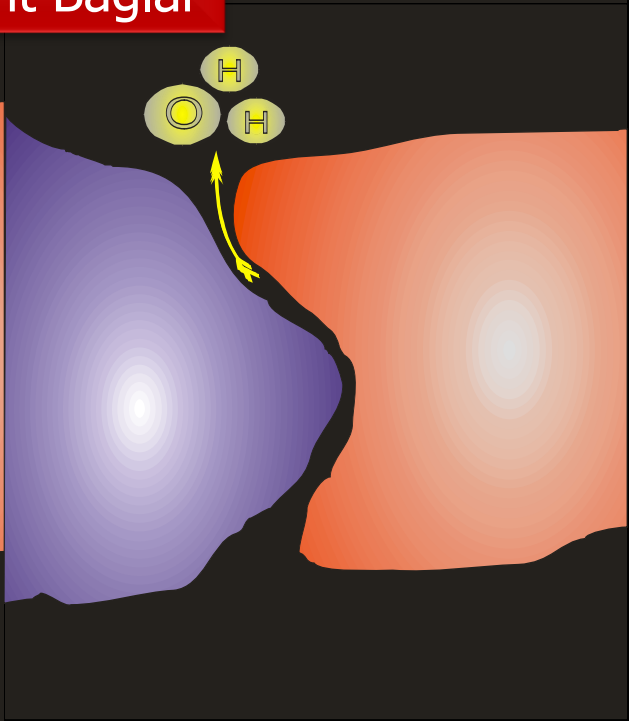

Hidrofobik bağ

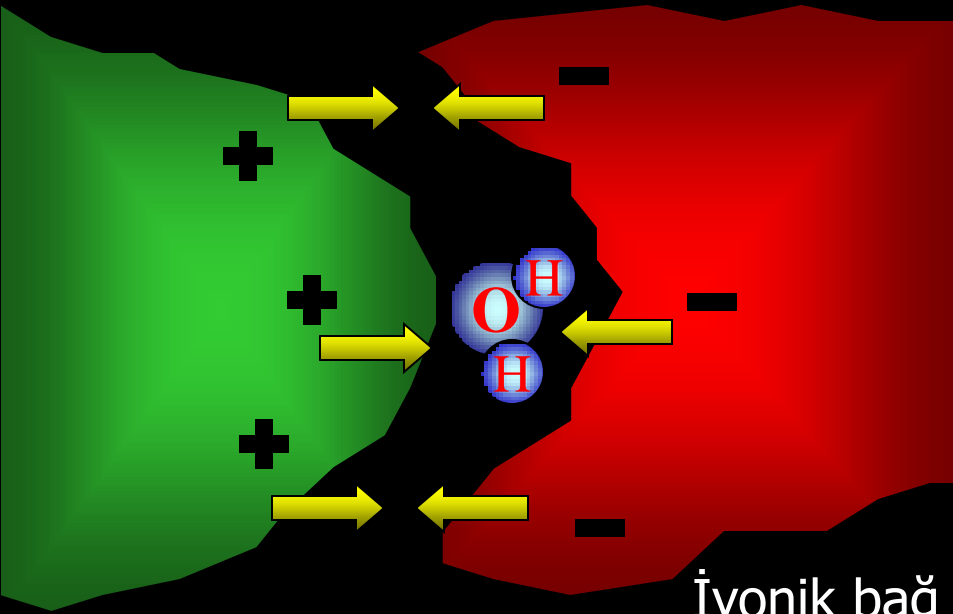

İyonik bağ  
VanDerWaals bağı

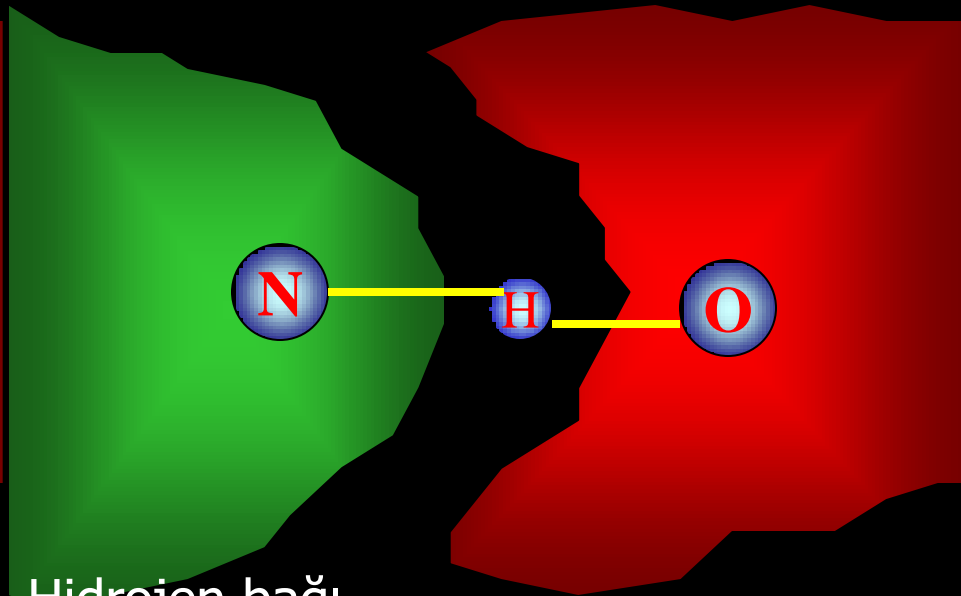

Hidrojen bağı  
Hidrofobik bağ

