

COM/BLM 453

Data Mining

Asst. Prof. Dr. Bulent TUGRUL

btugrul@eng.ankara.edu.tr

Slides are mainly based on:

Introduction to Data Mining

by Pang-Ning Tan, Michael Steinbach, Vipin Kumar

Pearson, 1st Edition, 2005

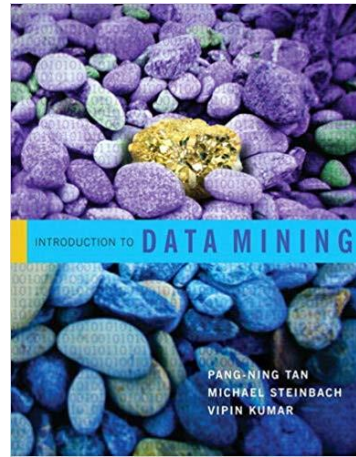

Data Mining

Classification: Basic Concepts, Decision Trees, and Model Evaluation

Lecture Notes for Chapter 4

Introduction to Data Mining

by

Tan, Steinbach, Kumar

Classification: Definition

- Given a collection of records (*training set*)
 - Each record contains a set of *attributes*, one of the attributes is the *class*.
- Find a *model* for class attribute as a function of the values of other attributes.
- Goal: previously unseen records should be assigned a class as accurately as possible.
 - A *test set* is used to determine the accuracy of the model. Usually, the given data set is divided into training and test sets, with training set used to build the model and test set used to validate it.

Illustrating Classification Task

Tid	Attrib1	Attrib2	Attrib3	Class
1	Yes	Large	125K	No
2	No	Medium	100K	No
3	No	Small	70K	No
4	Yes	Medium	120K	No
5	No	Large	95K	Yes
6	No	Medium	60K	No
7	Yes	Large	220K	No
8	No	Small	85K	Yes
9	No	Medium	75K	No
10	No	Small	90K	Yes

Training Set

Tid	Attrib1	Attrib2	Attrib3	Class
11	No	Small	55K	?
12	Yes	Medium	80K	?
13	Yes	Large	110K	?
14	No	Small	95K	?
15	No	Large	67K	?

Test Set

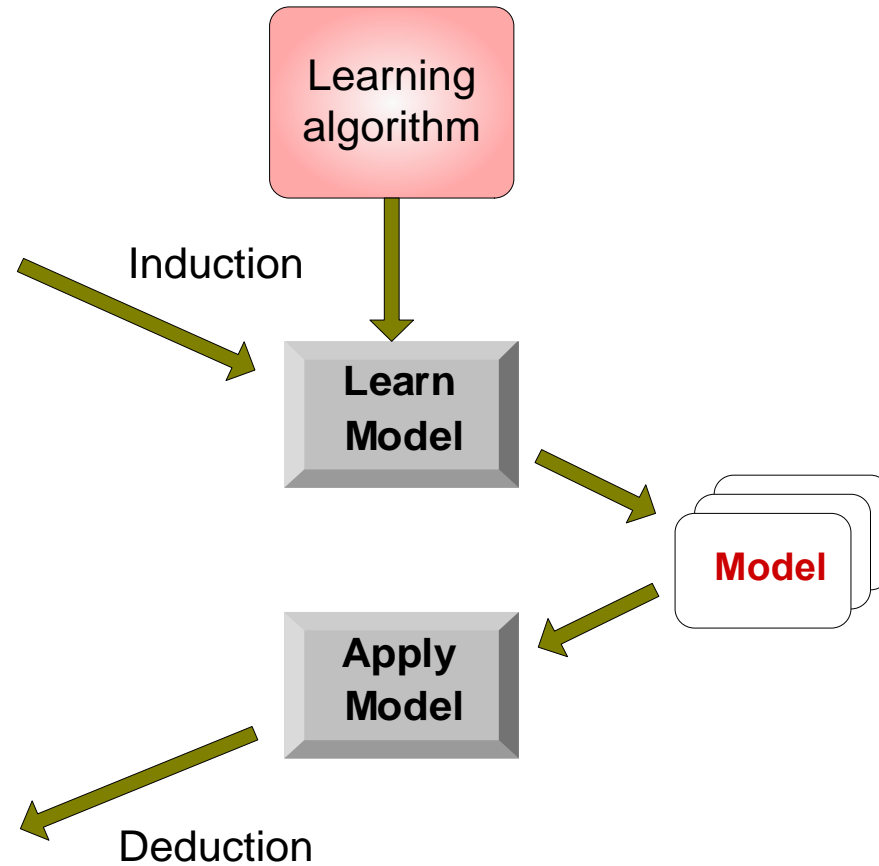

Examples of Classification Task

- Predicting tumor cells as benign or malignant
- Classifying credit card transactions as legitimate or fraudulent
- Classifying secondary structures of protein as alpha-helix, beta-sheet, or random coil
- Categorizing news stories as finance, weather, entertainment, sports, etc

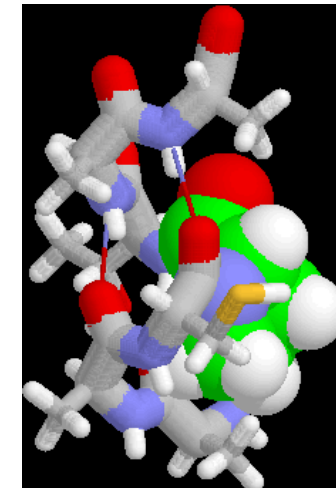

Classification Techniques

- Decision Tree based Methods
- Rule-based Methods
- Memory based reasoning
- Neural Networks
- Naïve Bayes and Bayesian Belief Networks
- Support Vector Machines

Example of a Decision Tree

<i>Tid</i>	Refund	Marital Status	Taxable Income	Cheat
1	Yes	Single	125K	No
2	No	Married	100K	No
3	No	Single	70K	No
4	Yes	Married	120K	No
5	No	Divorced	95K	Yes
6	No	Married	60K	No
7	Yes	Divorced	220K	No
8	No	Single	85K	Yes
9	No	Married	75K	No
10	No	Single	90K	Yes

categorical
categorical
continuous
class

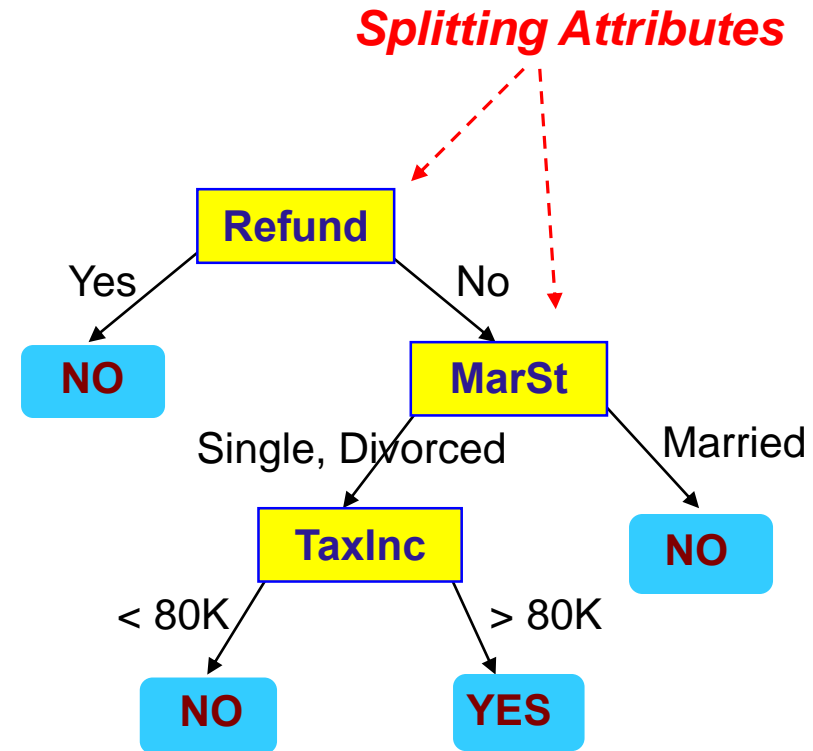

Training Data

Model: Decision Tree

Another Example of Decision Tree

categorical
categorical
continuous
class

<i>Tid</i>	Refund	Marital Status	Taxable Income	Cheat
1	Yes	Single	125K	No
2	No	Married	100K	No
3	No	Single	70K	No
4	Yes	Married	120K	No
5	No	Divorced	95K	Yes
6	No	Married	60K	No
7	Yes	Divorced	220K	No
8	No	Single	85K	Yes
9	No	Married	75K	No
10	No	Single	90K	Yes

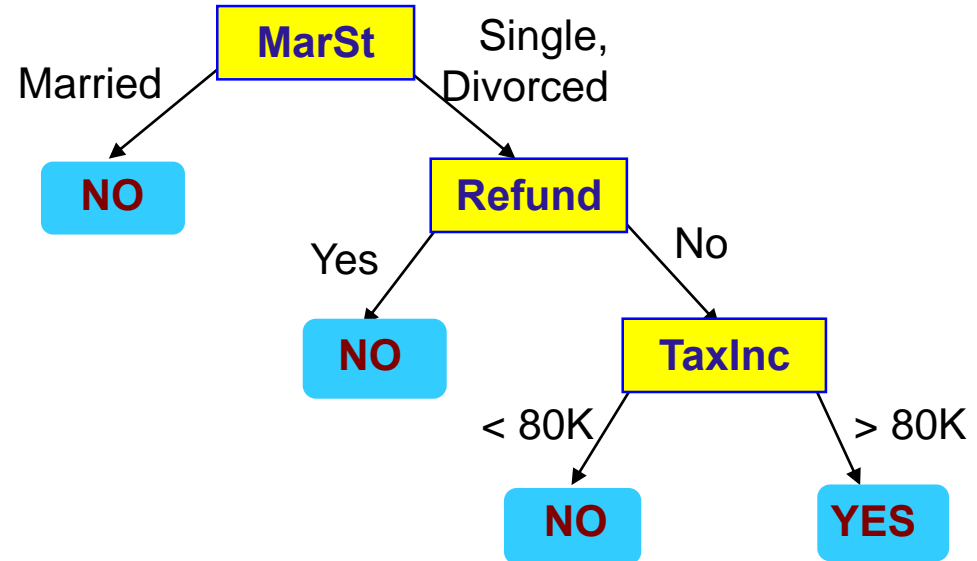

There could be more than one tree that fits the same data!

Decision Tree Classification Task

Tid	Attrib1	Attrib2	Attrib3	Class
1	Yes	Large	125K	No
2	No	Medium	100K	No
3	No	Small	70K	No
4	Yes	Medium	120K	No
5	No	Large	95K	Yes
6	No	Medium	60K	No
7	Yes	Large	220K	No
8	No	Small	85K	Yes
9	No	Medium	75K	No
10	No	Small	90K	Yes

Training Set

Tid	Attrib1	Attrib2	Attrib3	Class
11	No	Small	55K	?
12	Yes	Medium	80K	?
13	Yes	Large	110K	?
14	No	Small	95K	?
15	No	Large	67K	?

Test Set

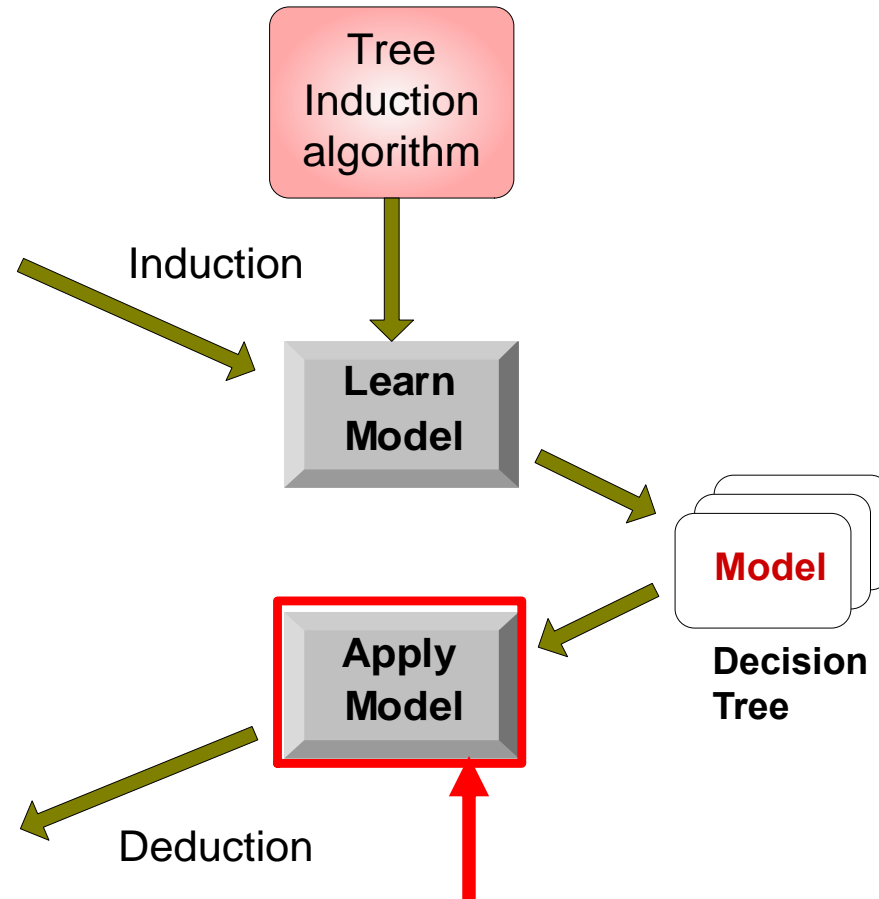

Apply Model to Test Data

Start from the root of tree.

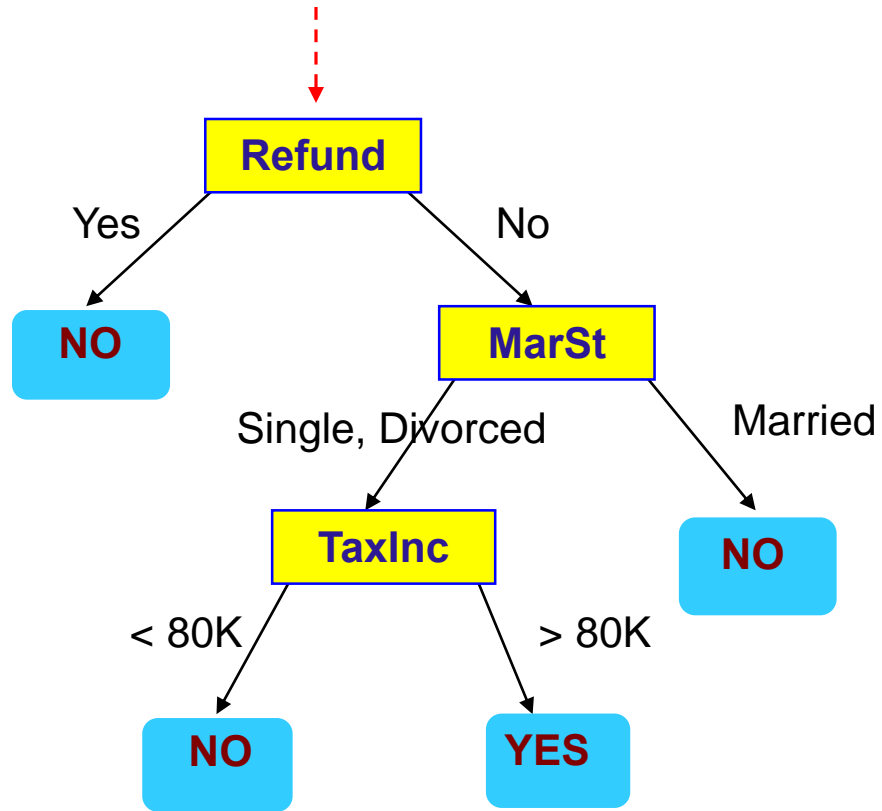

Test Data

Refund	Marital Status	Taxable Income	Cheat
No	Married	80K	?

Apply Model to Test Data

Test Data

Refund	Marital Status	Taxable Income	Cheat
No	Married	80K	?

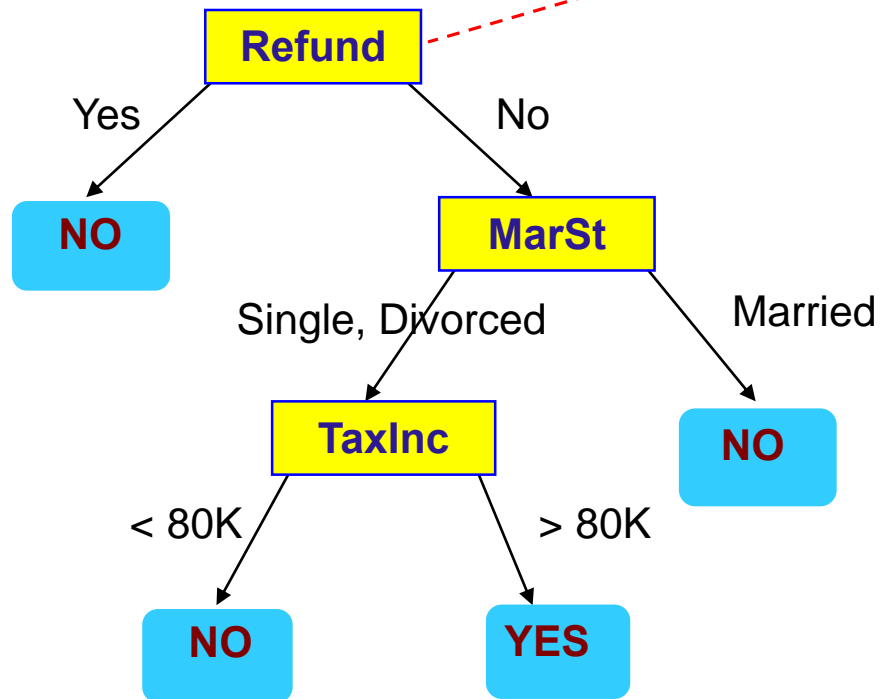

Apply Model to Test Data

Test Data

Refund	Marital Status	Taxable Income	Cheat
No	Married	80K	?

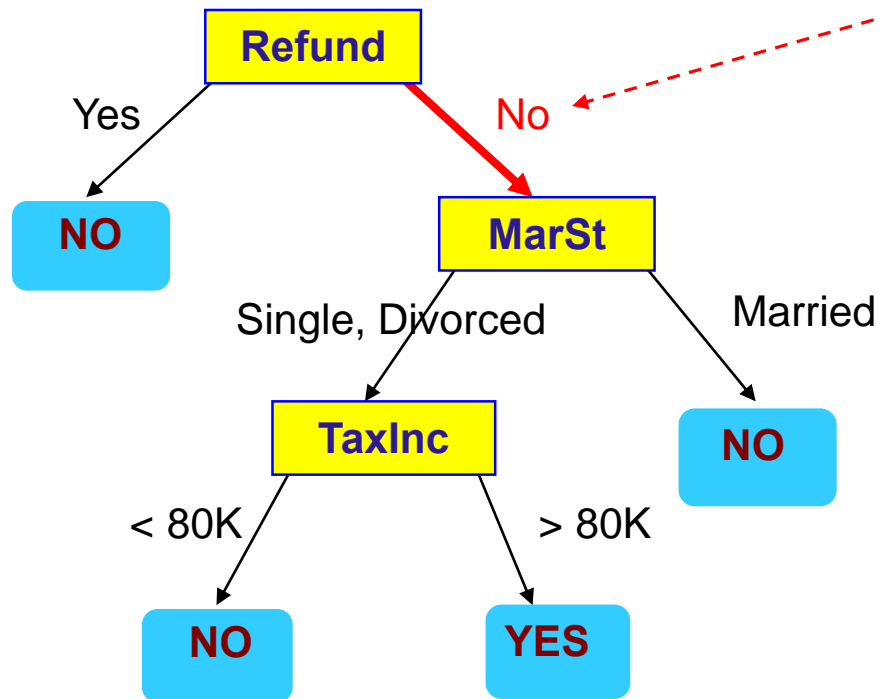

Apply Model to Test Data

Test Data

Refund	Marital Status	Taxable Income	Cheat
No	Married	80K	?

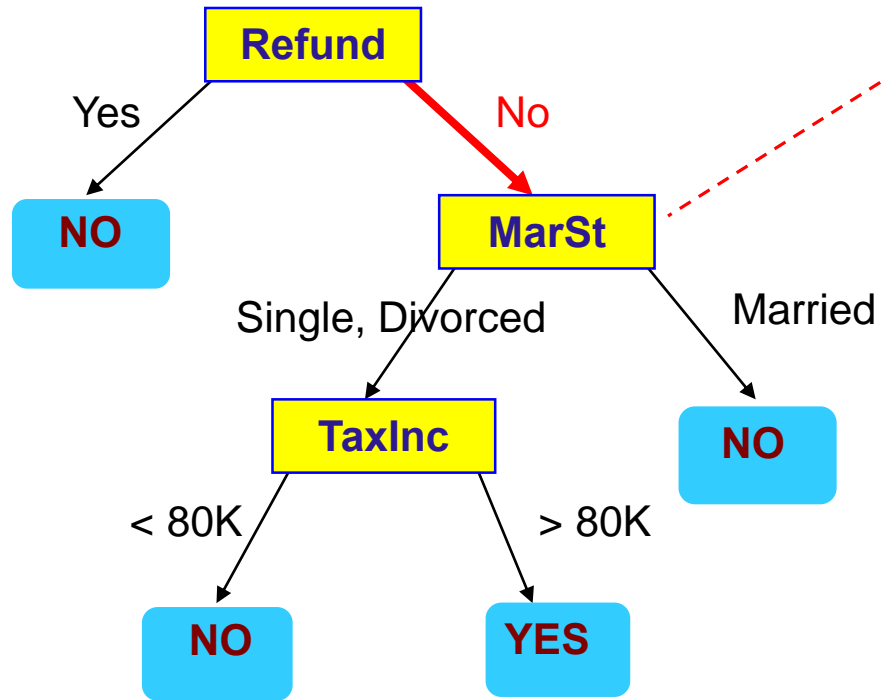

Apply Model to Test Data

Test Data

Refund	Marital Status	Taxable Income	Cheat
No	Married	80K	?

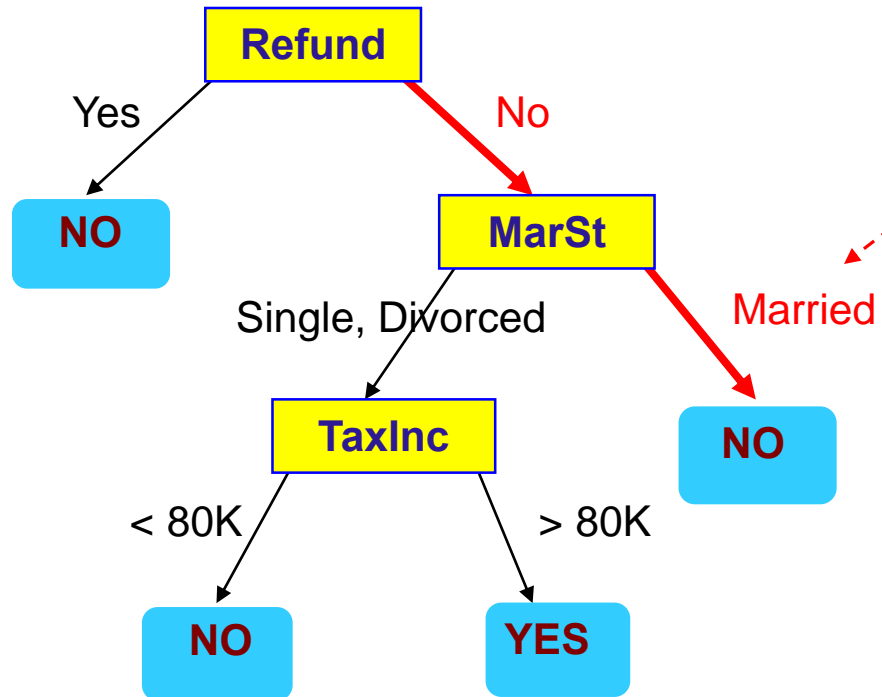

Apply Model to Test Data

Test Data

Refund	Marital Status	Taxable Income	Cheat
No	Married	80K	?

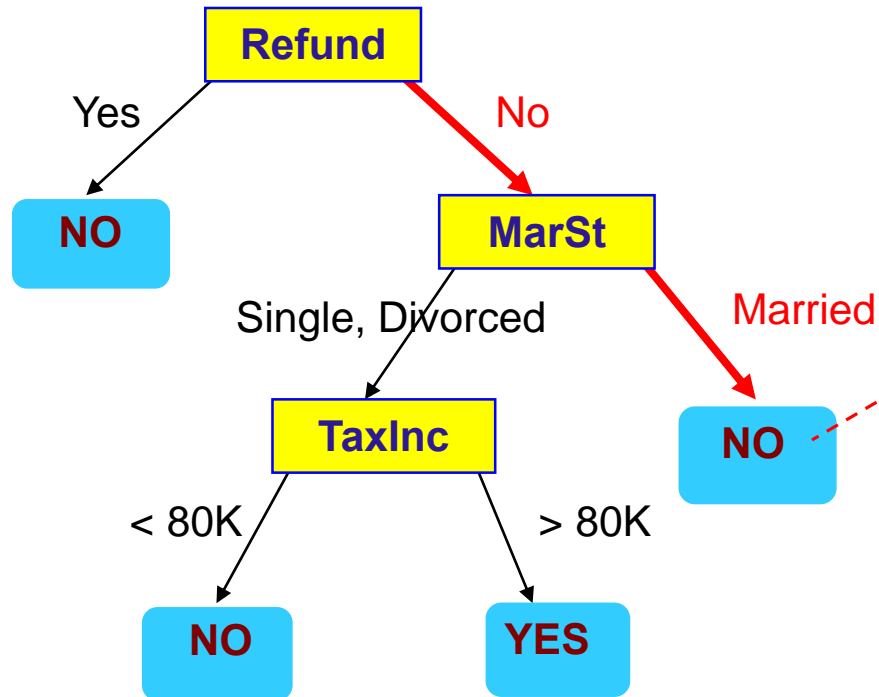

Assign Cheat to "No"

Decision Tree Classification Task

Tid	Attrib1	Attrib2	Attrib3	Class
1	Yes	Large	125K	No
2	No	Medium	100K	No
3	No	Small	70K	No
4	Yes	Medium	120K	No
5	No	Large	95K	Yes
6	No	Medium	60K	No
7	Yes	Large	220K	No
8	No	Small	85K	Yes
9	No	Medium	75K	No
10	No	Small	90K	Yes

Training Set

Tid	Attrib1	Attrib2	Attrib3	Class
11	No	Small	55K	?
12	Yes	Medium	80K	?
13	Yes	Large	110K	?
14	No	Small	95K	?
15	No	Large	67K	?

Test Set

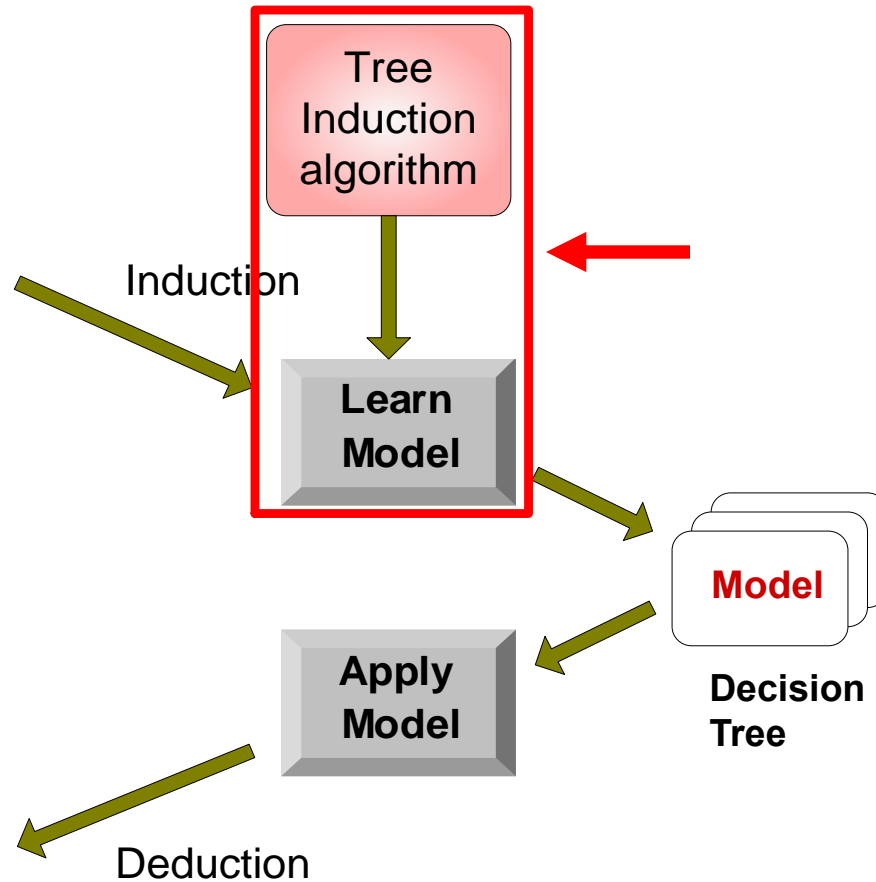

Decision Tree Induction

- Many Algorithms:
 - Hunt's Algorithm (one of the earliest)
 - CART
 - ID3, C4.5
 - SLIQ, SPRINT

General Structure of Hunt's Algorithm

- Let D_t be the set of training records that reach a node t
- General Procedure:
 - If D_t contains records that belong the same class y_t , then t is a leaf node labeled as y_t
 - If D_t is an empty set, then t is a leaf node labeled by the default class, y_d
 - If D_t contains records that belong to more than one class, use an attribute test to split the data into smaller subsets. Recursively apply the procedure to each subset.

<i>Tid</i>	Refund	Marital Status	Taxable Income	Cheat
1	Yes	Single	125K	No
2	No	Married	100K	No
3	No	Single	70K	No
4	Yes	Married	120K	No
5	No	Divorced	95K	Yes
6	No	Married	60K	No
7	Yes	Divorced	220K	No
8	No	Single	85K	Yes
9	No	Married	75K	No
10	No	Single	90K	Yes

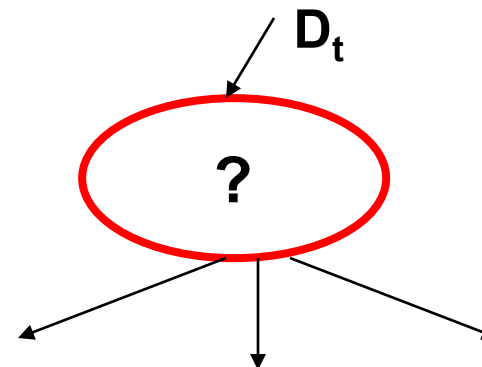

Hunt's Algorithm

Tid	Refund	Marital Status	Taxable Income	Cheat
1	Yes	Single	125K	No
2	No	Married	100K	No
3	No	Single	70K	No
4	Yes	Married	120K	No
5	No	Divorced	95K	Yes
6	No	Married	60K	No
7	Yes	Divorced	220K	No
8	No	Single	85K	Yes
9	No	Married	75K	No
10	No	Single	90K	Yes

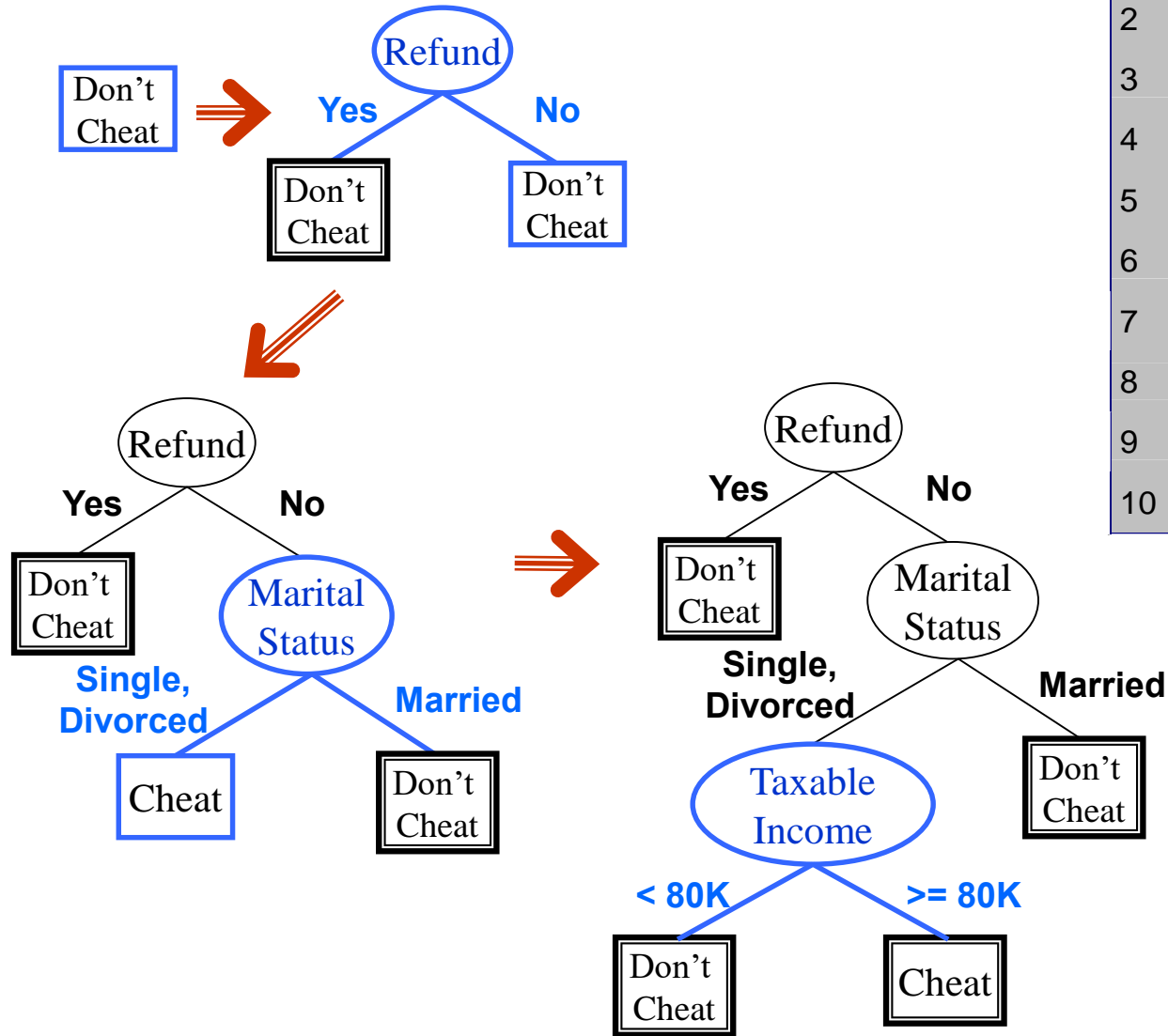

Tree Induction

- Greedy strategy.
 - Split the records based on an attribute test that optimizes certain criterion.

- Issues
 - Determine how to split the records
 - ◆ How to specify the attribute test condition?
 - ◆ How to determine the best split?
 - Determine when to stop splitting

Tree Induction

- Greedy strategy.
 - Split the records based on an attribute test that optimizes certain criterion.

- Issues
 - Determine how to split the records
 - ◆ How to specify the attribute test condition?
 - ◆ How to determine the best split?
 - Determine when to stop splitting

How to Specify Test Condition?

- Depends on attribute types
 - Nominal
 - Ordinal
 - Continuous

- Depends on number of ways to split
 - 2-way split
 - Multi-way split

Splitting Based on Nominal Attributes

- **Multi-way split:** Use as many partitions as distinct values.

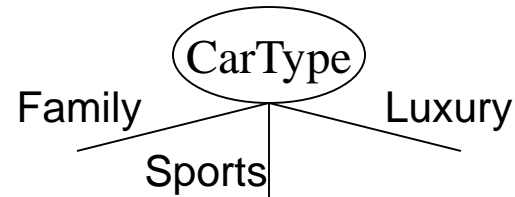

- **Binary split:** Divides values into two subsets. Need to find optimal partitioning.

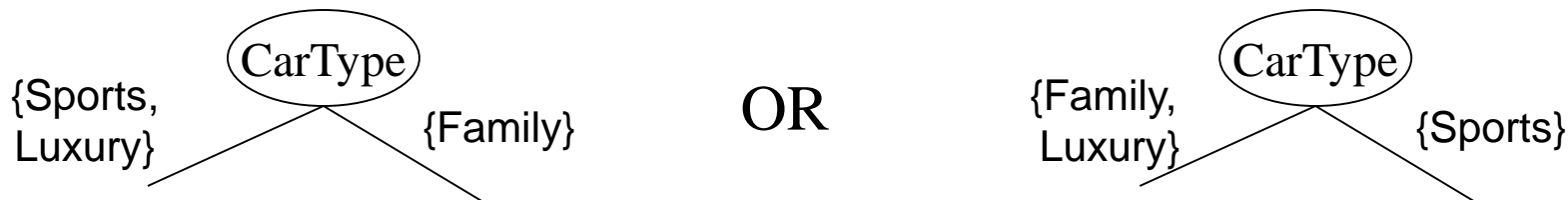

Splitting Based on Ordinal Attributes

- **Multi-way split:** Use as many partitions as distinct values.

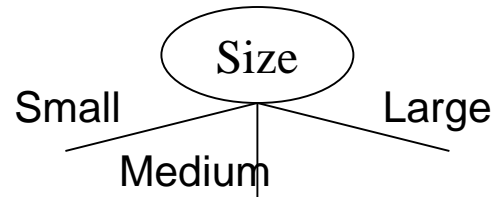

- **Binary split:** Divides values into two subsets. Need to find optimal partitioning.

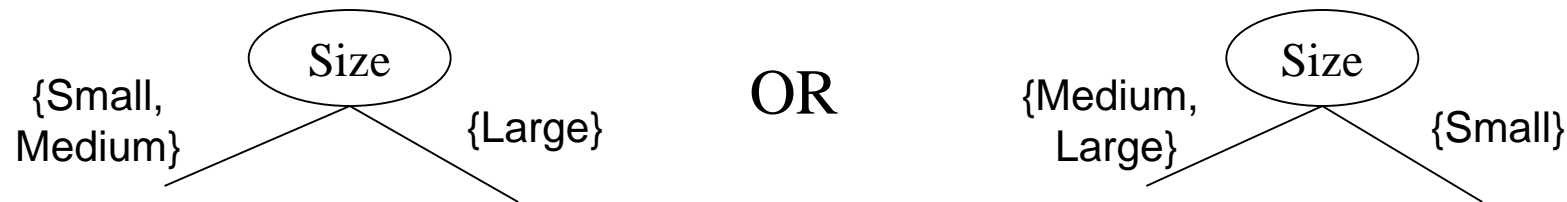

- **What about this split?**

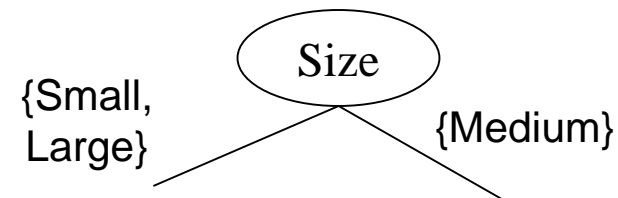

Splitting Based on Continuous Attributes

- Different ways of handling
 - **Discretization** to form an ordinal categorical attribute
 - ◆ Static – discretize once at the beginning
 - ◆ Dynamic – ranges can be found by equal interval bucketing, equal frequency bucketing (percentiles), or clustering.
 - **Binary Decision**: $(A < v)$ or $(A \geq v)$
 - ◆ consider all possible splits and finds the best cut
 - ◆ can be more compute intensive

Splitting Based on Continuous Attributes

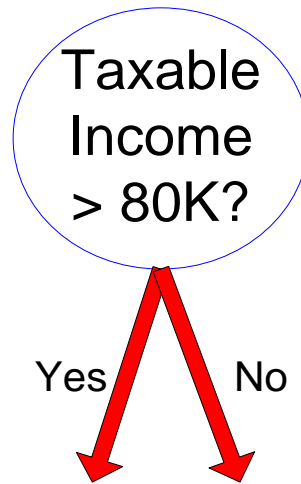

(i) Binary split

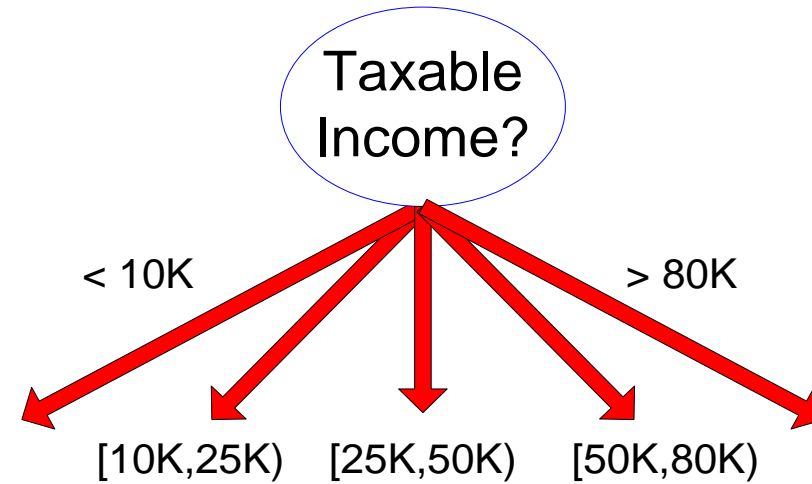

(ii) Multi-way split

Tree Induction

- Greedy strategy.
 - Split the records based on an attribute test that optimizes certain criterion.

- Issues
 - Determine how to split the records
 - ◆ How to specify the attribute test condition?
 - ◆ **How to determine the best split?**
 - Determine when to stop splitting

How to determine the Best Split

Before Splitting: 10 records of class 0,
10 records of class 1

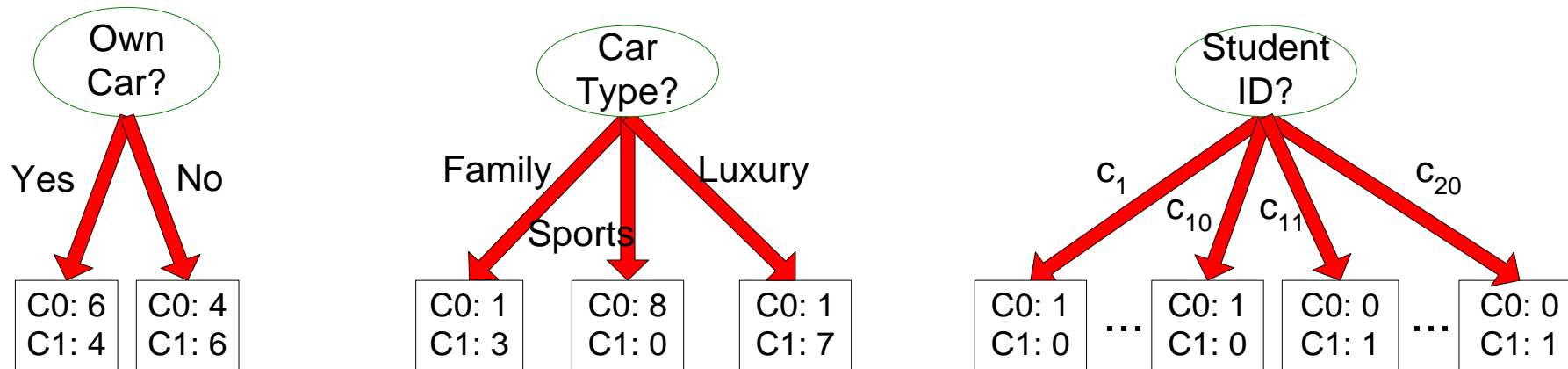

Which test condition is the best?

How to determine the Best Split

- Greedy approach:
 - Nodes with **homogeneous** class distribution are preferred
- Need a measure of node impurity:

C0: 5
C1: 5

**Non-homogeneous,
High degree of impurity**

C0: 9
C1: 1

**Homogeneous,
Low degree of impurity**

Measures of Node Impurity

- Gini Index
- Entropy
- Misclassification error

How to Find the Best Split

Before Splitting:

C0	N00
C1	N01

→ **M0**

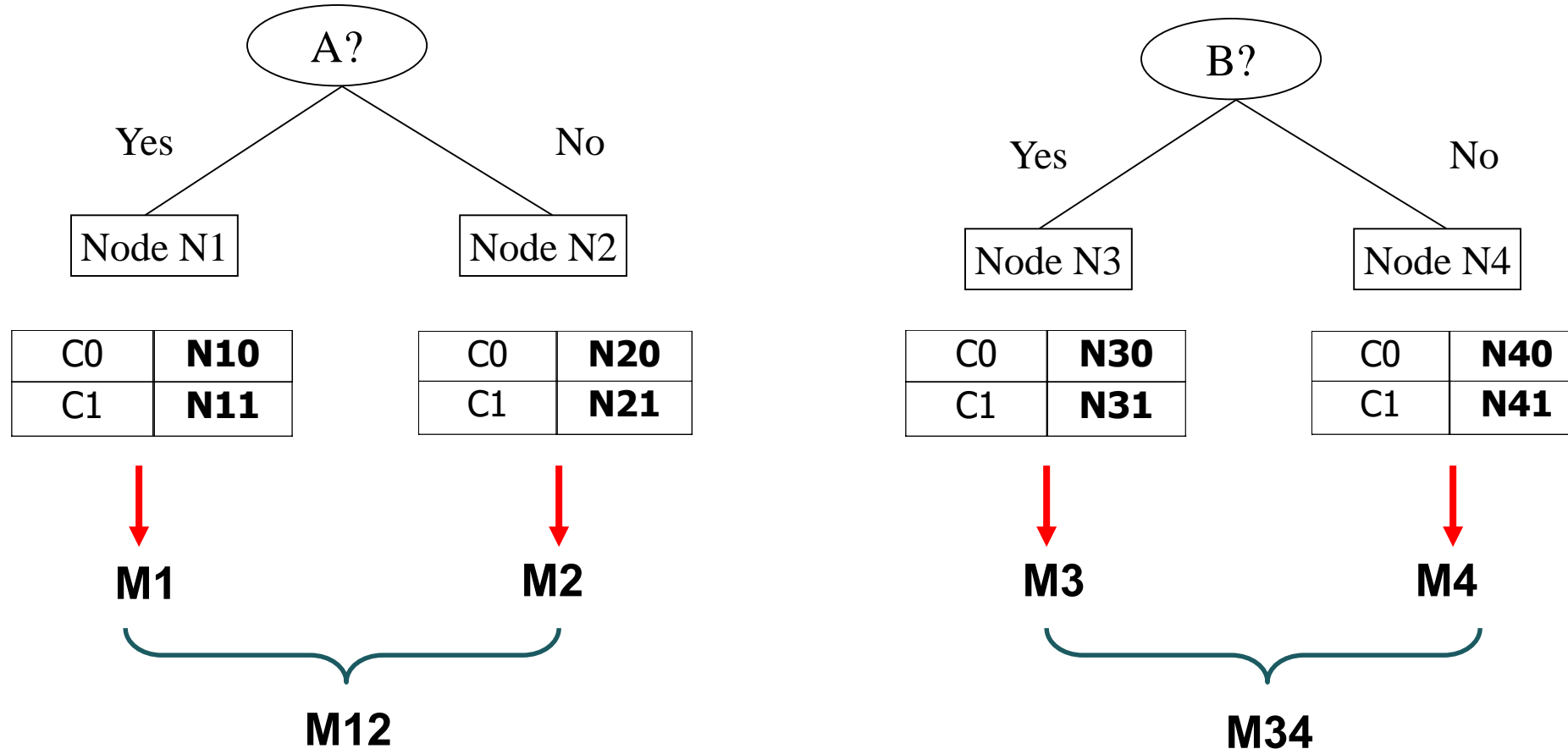

Gain = M0 – M12 vs M0 – M34

Measure of Impurity: GINI

- Gini Index for a given node t :

$$GINI(t) = 1 - \sum_j [p(j|t)]^2$$

(NOTE: $p(j|t)$ is the relative frequency of class j at node t).

- Maximum ($1 - 1/n_c$) when records are equally distributed among all classes, implying least interesting information
- Minimum (0.0) when all records belong to one class, implying most interesting information

C1	0
C2	6
Gini=0.000	

C1	1
C2	5
Gini=0.278	

C1	2
C2	4
Gini=0.444	

C1	3
C2	3
Gini=0.500	

Examples for computing GINI

$$GINI(t) = 1 - \sum_j [p(j|t)]^2$$

C1	0
C2	6

$$P(C1) = 0/6 = 0 \quad P(C2) = 6/6 = 1$$

$$Gini = 1 - P(C1)^2 - P(C2)^2 = 1 - 0 - 1 = 0$$

C1	1
C2	5

$$P(C1) = 1/6 \quad P(C2) = 5/6$$

$$Gini = 1 - (1/6)^2 - (5/6)^2 = 0.278$$

C1	2
C2	4

$$P(C1) = 2/6 \quad P(C2) = 4/6$$

$$Gini = 1 - (2/6)^2 - (4/6)^2 = 0.444$$

Splitting Based on GINI

- Used in CART, SLIQ, SPRINT.
- When a node p is split into k partitions (children), the quality of split is computed as,

$$GINI_{split} = \sum_{i=1}^k \frac{n_i}{n} GINI(i)$$

where, n_i = number of records at child i ,
 n = number of records at node p .

Binary Attributes: Computing GINI Index

- Splits into two partitions
- Effect of Weighing partitions:
 - Larger and Purer Partitions are sought for.

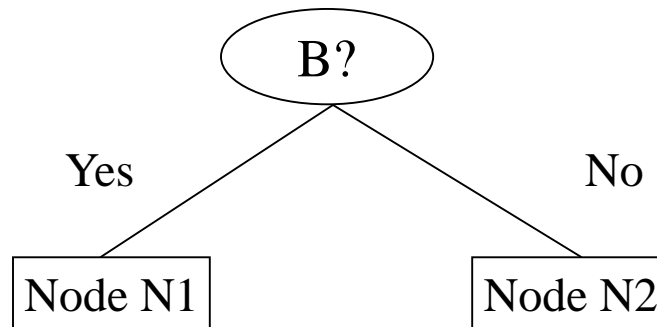

	Parent
C1	6
C2	6
Gini = 0.500	

$$\begin{aligned} \text{Gini}(N1) &= 1 - (5/7)^2 - (2/7)^2 \\ &= 0.408 \end{aligned}$$

$$\begin{aligned} \text{Gini}(N2) &= 1 - (1/5)^2 - (4/5)^2 \\ &= 0.320 \end{aligned}$$

	N1	N2
C1	5	1
C2	2	4
Gini=0.371		

$$\begin{aligned} \text{Gini(Children)} &= 7/12 * 0.408 + \\ &\quad 5/12 * 0.320 \\ &= 0.371 \end{aligned}$$

Categorical Attributes: Computing Gini Index

- For each distinct value, gather counts for each class in the dataset
- Use the count matrix to make decisions

Multi-way split

	CarType		
	Family	Sports	Luxury
C1	1	2	1
C2	4	1	1
Gini	0.393		

Two-way split
(find best partition of values)

	CarType	
	{Sports, Luxury}	{Family}
C1	3	1
C2	2	4
Gini	0.400	

	CarType	
	{Sports}	{Family, Luxury}
C1	2	2
C2	1	5
Gini	0.419	

Continuous Attributes: Computing Gini Index

- Use Binary Decisions based on one value
- Several Choices for the splitting value
 - Number of possible splitting values = Number of distinct values
- Each splitting value has a count matrix associated with it
 - Class counts in each of the partitions, $A < v$ and $A \geq v$
- Simple method to choose best v
 - For each v , scan the database to gather count matrix and compute its Gini index
 - Computationally Inefficient! Repetition of work.

Tid	Refund	Marital Status	Taxable Income	Cheat
1	Yes	Single	125K	No
2	No	Married	100K	No
3	No	Single	70K	No
4	Yes	Married	120K	No
5	No	Divorced	95K	Yes
6	No	Married	60K	No
7	Yes	Divorced	220K	No
8	No	Single	85K	Yes
9	No	Married	75K	No
10	No	Single	90K	Yes

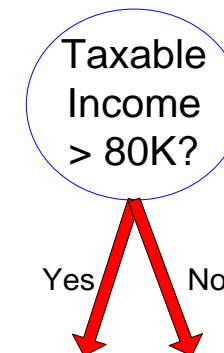

Continuous Attributes: Computing Gini Index...

- For efficient computation: for each attribute,
 - Sort the attribute on values
 - Linearly scan these values, each time updating the count matrix and computing gini index
 - Choose the split position that has the least gini index

Cheat	No	No	No	Yes	Yes	Yes	No	No	No	No												
		Taxable Income																				
Sorted Values	60	70	75	85	90	95	100	120	125	220												
Split Positions	55	65	72	80	87	92	97	110	122	172	230											
	<=	>	<=	>	<=	>	<=	>	<=	>	<=	>	<=	>	<=	>						
Yes	0	3	0	3	0	3	0	3	1	2	2	1	3	0	3	0	3	0	3	0		
No	0	7	1	6	2	5	3	4	3	4	3	4	3	4	4	3	5	2	6	1	7	0
Gini	0.420	0.400	0.375	0.343	0.417	0.400	<u>0.300</u>	0.343	0.375	0.400	0.420											

Alternative Splitting Criteria based on INFO

- Entropy at a given node t :

$$Entropy(t) = -\sum_j p(j | t) \log p(j | t)$$

(NOTE: $p(j | t)$ is the relative frequency of class j at node t).

- Measures homogeneity of a node.
 - ◆ Maximum ($\log n_c$) when records are equally distributed among all classes implying least information
 - ◆ Minimum (0.0) when all records belong to one class, implying most information
- Entropy based computations are similar to the GINI index computations

Examples for computing Entropy

$$Entropy(t) = -\sum_j p(j|t) \log_2 p(j|t)$$

C1	0
C2	6

$$P(C1) = 0/6 = 0 \quad P(C2) = 6/6 = 1$$

$$Entropy = -0 \log 0 - 1 \log 1 = -0 - 0 = 0$$

C1	1
C2	5

$$P(C1) = 1/6 \quad P(C2) = 5/6$$

$$Entropy = - (1/6) \log_2 (1/6) - (5/6) \log_2 (5/6) = 0.65$$

C1	2
C2	4

$$P(C1) = 2/6 \quad P(C2) = 4/6$$

$$Entropy = - (2/6) \log_2 (2/6) - (4/6) \log_2 (4/6) = 0.92$$

Splitting Based on INFO...

- Information Gain:

$$GAIN_{split} = Entropy(p) - \left(\sum_{i=1}^k \frac{n_i}{n} Entropy(i) \right)$$

Parent Node, p is split into k partitions;

n_i is number of records in partition i

- Measures Reduction in Entropy achieved because of the split. Choose the split that achieves most reduction (maximizes GAIN)
- Used in ID3 and C4.5
- Disadvantage: Tends to prefer splits that result in large number of partitions, each being small but pure.

Splitting Based on INFO...

- Gain Ratio:

$$\text{GainRATIO}_{split} = \frac{GAIN_{split}}{SplitINFO} \quad \text{SplitINFO} = -\sum_{i=1}^k \frac{n_i}{n} \log \frac{n_i}{n}$$

Parent Node, p is split into k partitions

n_i is the number of records in partition i

- Adjusts Information Gain by the entropy of the partitioning (SplitINFO). Higher entropy partitioning (large number of small partitions) is penalized!
- Used in C4.5
- Designed to overcome the disadvantage of Information Gain

Splitting Criteria based on Classification Error

- Classification error at a node t :

$$Error(t) = 1 - \max_i P(i | t)$$

- Measures misclassification error made by a node.
 - ◆ Maximum ($1 - 1/n_c$) when records are equally distributed among all classes, implying least interesting information
 - ◆ Minimum (0.0) when all records belong to one class, implying most interesting information

Examples for Computing Error

$$Error(t) = 1 - \max_i P(i | t)$$

C1	0
C2	6

$$P(C1) = 0/6 = 0 \quad P(C2) = 6/6 = 1$$

$$Error = 1 - \max(0, 1) = 1 - 1 = 0$$

C1	1
C2	5

$$P(C1) = 1/6 \quad P(C2) = 5/6$$

$$Error = 1 - \max(1/6, 5/6) = 1 - 5/6 = 1/6$$

C1	2
C2	4

$$P(C1) = 2/6 \quad P(C2) = 4/6$$

$$Error = 1 - \max(2/6, 4/6) = 1 - 4/6 = 1/3$$

Comparison among Splitting Criteria

For a 2-class problem:

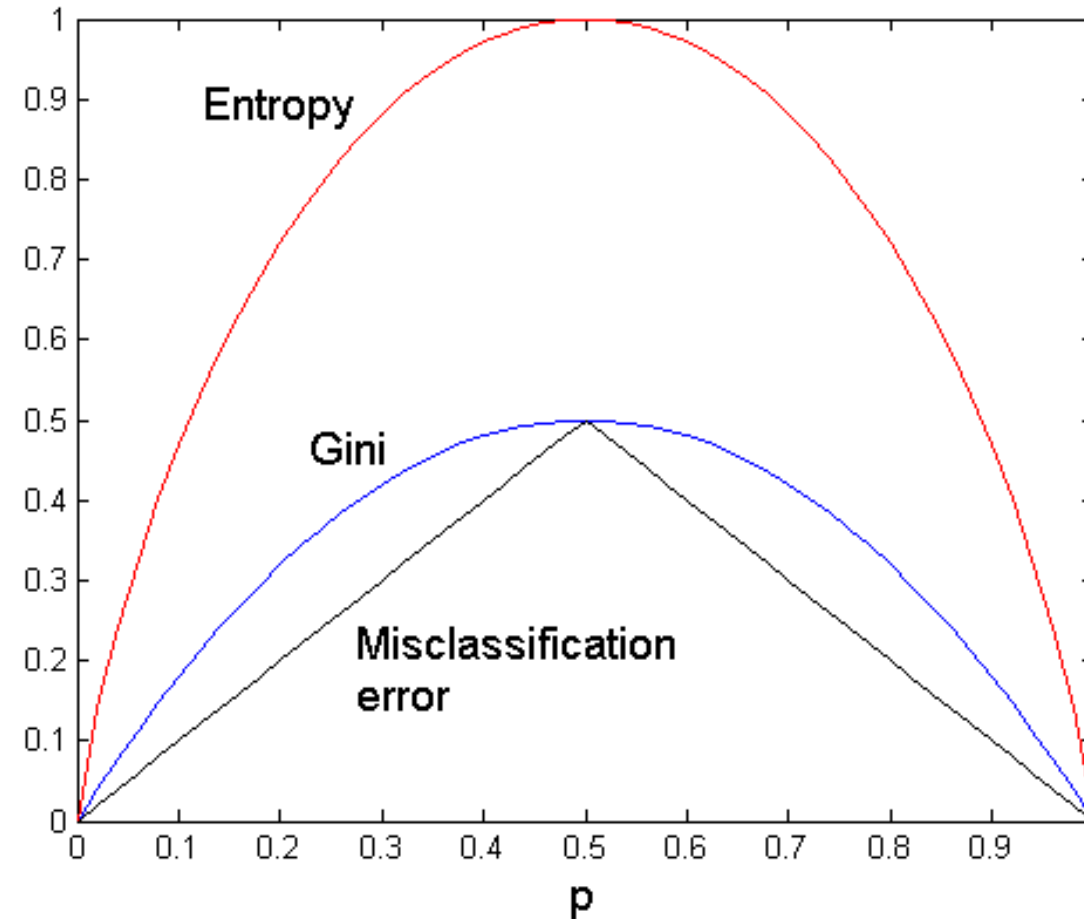

Tree Induction

- Greedy strategy.
 - Split the records based on an attribute test that optimizes certain criterion.

- Issues
 - Determine how to split the records
 - ◆ How to specify the attribute test condition?
 - ◆ How to determine the best split?
 - **Determine when to stop splitting**

Stopping Criteria for Tree Induction

- Stop expanding a node when all the records belong to the same class
- Stop expanding a node when all the records have similar attribute values
- Early termination (to be discussed later)

Decision Tree Based Classification

- Advantages:
 - Inexpensive to construct
 - Extremely fast at classifying unknown records
 - Easy to interpret for small-sized trees
 - Accuracy is comparable to other classification techniques for many simple data sets

Example: C4.5

- Simple depth-first construction.
- Uses Information Gain
- Sorts Continuous Attributes at each node.
- Needs entire data to fit in memory.
- Unsuitable for Large Datasets.
 - Needs out-of-core sorting.

- You can download the software from:
<http://www.cse.unsw.edu.au/~quinlan/c4.5r8.tar.gz>

Practical Issues of Classification

- Underfitting and Overfitting
- Missing Values
- Costs of Classification

Underfitting and Overfitting

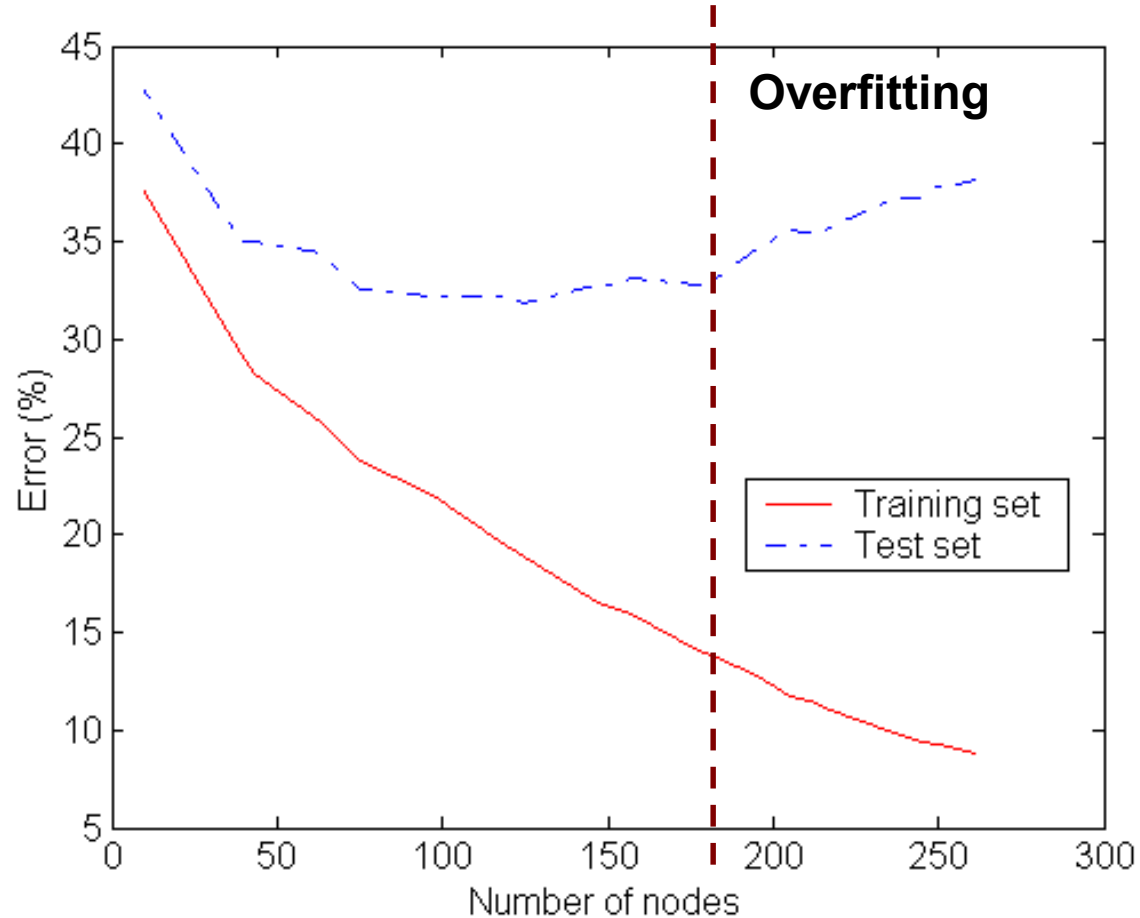

Underfitting: when model is too simple, both training and test errors are large

Overfitting due to Noise

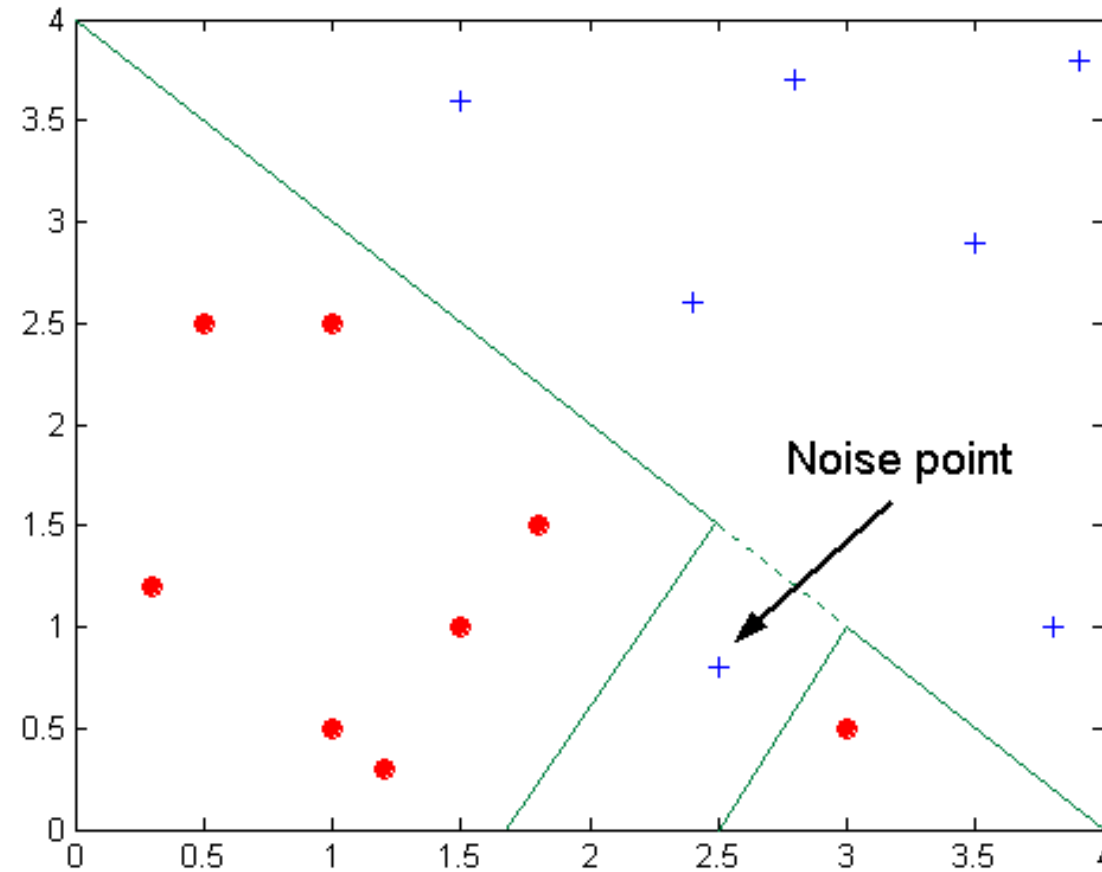

Decision boundary is distorted by noise point

Notes on Overfitting

- Overfitting results in decision trees that are more complex than necessary
- Training error no longer provides a good estimate of how well the tree will perform on previously unseen records
- Need new ways for estimating errors

Decision Boundary

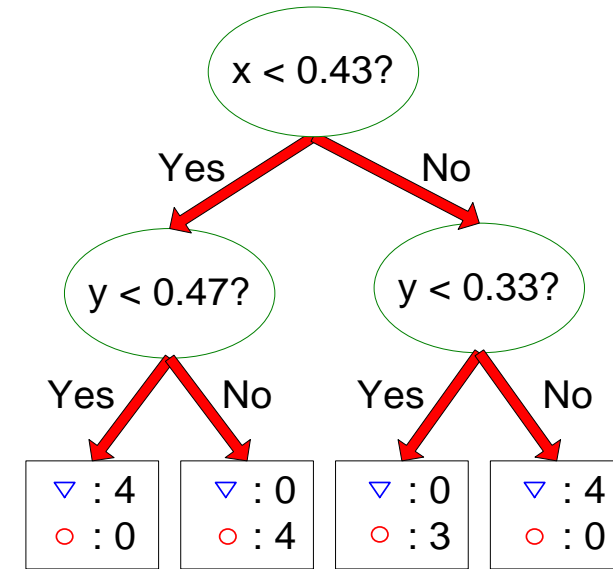
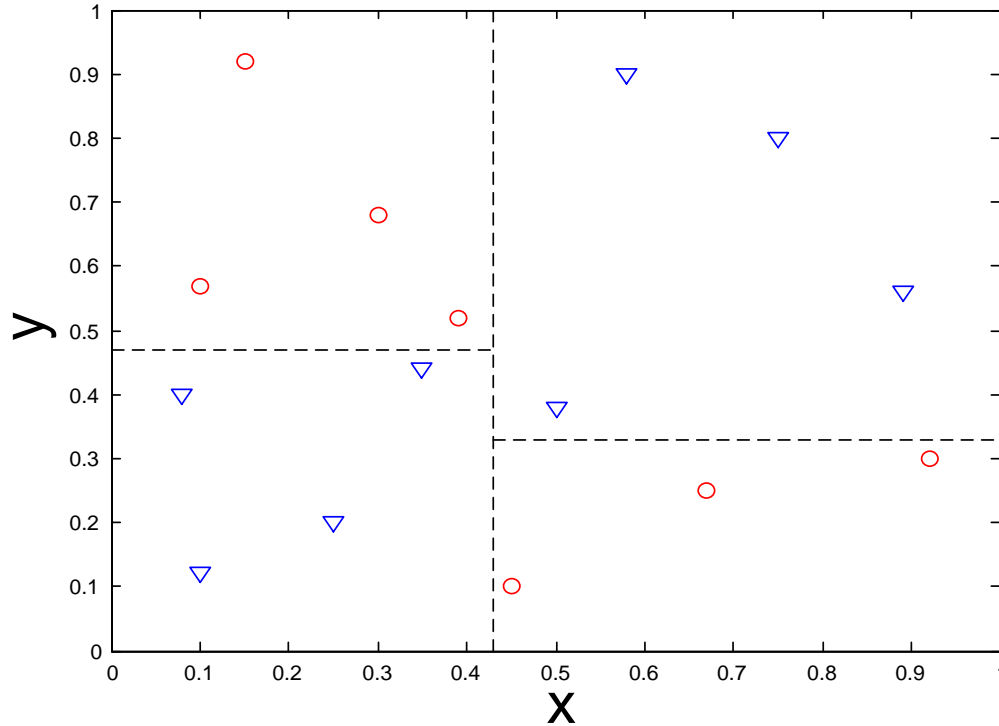

- Border line between two neighboring regions of different classes is known as decision boundary
- Decision boundary is parallel to axes because test condition involves a single attribute at-a-time

Oblique Decision Trees

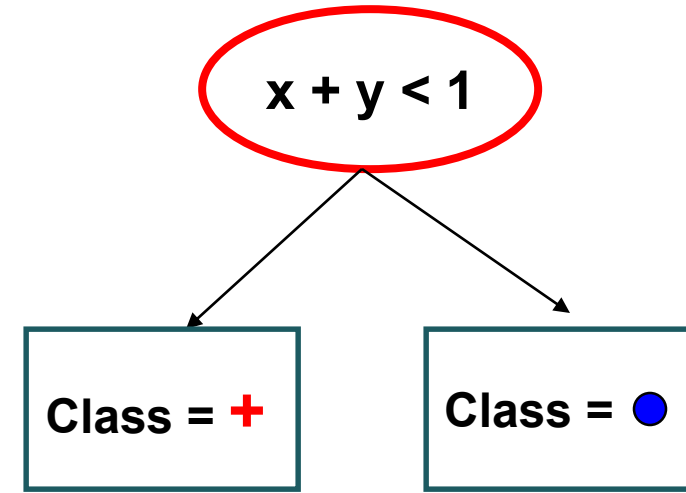
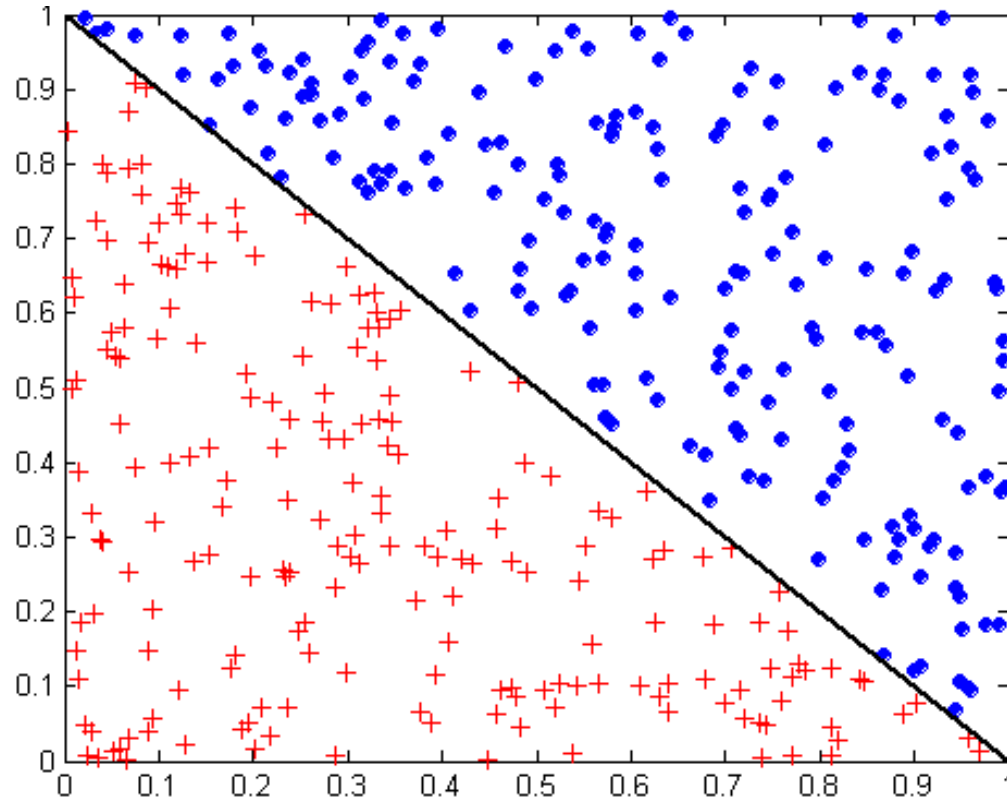

- Test condition may involve multiple attributes
- More expressive representation
- Finding optimal test condition is computationally expensive

Model Evaluation

- Metrics for Performance Evaluation
 - How to evaluate the performance of a model?
- Methods for Performance Evaluation
 - How to obtain reliable estimates?

Metrics for Performance Evaluation

- Focus on the predictive capability of a model
 - Rather than how fast it takes to classify or build models, scalability, etc.
- Confusion Matrix:

		PREDICTED CLASS	
		Class=Yes	Class=No
ACTUAL CLASS	Class=Yes	a	b
	Class=No	c	d

a: TP (true positive)
b: FN (false negative)
c: FP (false positive)
d: TN (true negative)

Metrics for Performance Evaluation...

	PREDICTED CLASS		
	Class=Yes	Class=No	
ACTUAL CLASS	Class=Yes	a (TP)	b (FN)
	Class=No	c (FP)	d (TN)

- Most widely-used metric:

$$\text{Accuracy} = \frac{a + d}{a + b + c + d} = \frac{TP + TN}{TP + TN + FP + FN}$$

Limitation of Accuracy

- Consider a 2-class problem
 - Number of Class 0 examples = 9990
 - Number of Class 1 examples = 10
- If model predicts everything to be class 0, accuracy is $9990/10000 = 99.9\%$
 - Accuracy is misleading because model does not detect any class 1 example

Cost Matrix

	PREDICTED CLASS		
	$C(i j)$	Class=Yes	Class=No
ACTUAL CLASS	Class=Yes	$C(\text{Yes} \text{Yes})$	$C(\text{No} \text{Yes})$
	Class=No	$C(\text{Yes} \text{No})$	$C(\text{No} \text{No})$

$C(i|j)$: Cost of misclassifying class j example as class i

Computing Cost of Classification

Cost Matrix	PREDICTED CLASS		
	C(i j)	+	-
ACTUAL CLASS	+	-1	100
	-	1	0

Model M_1	PREDICTED CLASS		
ACTUAL CLASS		+	-
	+	150	40
	-	60	250

Accuracy = 80%

Cost = 3910

Model M_2	PREDICTED CLASS		
ACTUAL CLASS		+	-
	+	250	45
	-	5	200

Accuracy = 90%

Cost = 4255

Cost vs Accuracy

Count	PREDICTED CLASS		
	Class=Yes	Class=No	
ACTUAL CLASS	Class=Yes	a	b
	Class=No	c	d

Accuracy is proportional to cost if

1. $C(\text{Yes}|\text{No})=C(\text{No}|\text{Yes}) = q$
2. $C(\text{Yes}|\text{Yes})=C(\text{No}|\text{No}) = p$

$$N = a + b + c + d$$

$$\text{Accuracy} = (a + d)/N$$

Cost	PREDICTED CLASS		
	Class=Yes	Class=No	
ACTUAL CLASS	Class=Yes	p	q
	Class=No	q	p

$$\text{Cost} = p(a + d) + q(b + c)$$

$$= p(a + d) + q(N - a - d)$$

$$= qN - (q - p)(a + d)$$

$$= N[q - (q - p) \times \text{Accuracy}]$$

Model Evaluation

- Metrics for Performance Evaluation
 - How to evaluate the performance of a model?
- **Methods for Performance Evaluation**
 - How to obtain reliable estimates?

Methods of Estimation

- Holdout
 - Reserve 2/3 for training and 1/3 for testing
- Random subsampling
 - Repeated holdout
- Cross validation
 - Partition data into k disjoint subsets
 - k -fold: train on $k-1$ partitions, test on the remaining one
 - Leave-one-out: $k = n$
- Stratified sampling
 - oversampling vs undersampling
- Bootstrap
 - Sampling with replacement