

COM/BLM 426
Information Security
Asst. Prof. Dr. Bulent TUGRUL
btugrul@eng.ankara.edu.tr

Slides are mainly based on:

[Understanding Cryptography: A Textbook for Students and Practitioners](#)

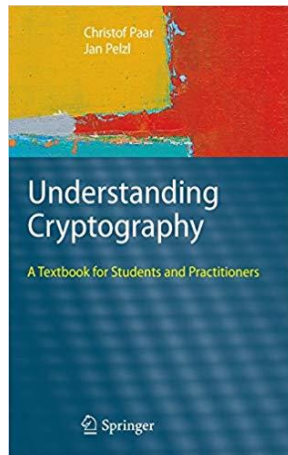

by Christof Paar and Jan Pelzl
Springer, 1st Edition, 2010

Understanding Cryptography – A Textbook for Students and Practitioners

by Christof Paar and Jan Pelzl

www.crypto-textbook.com

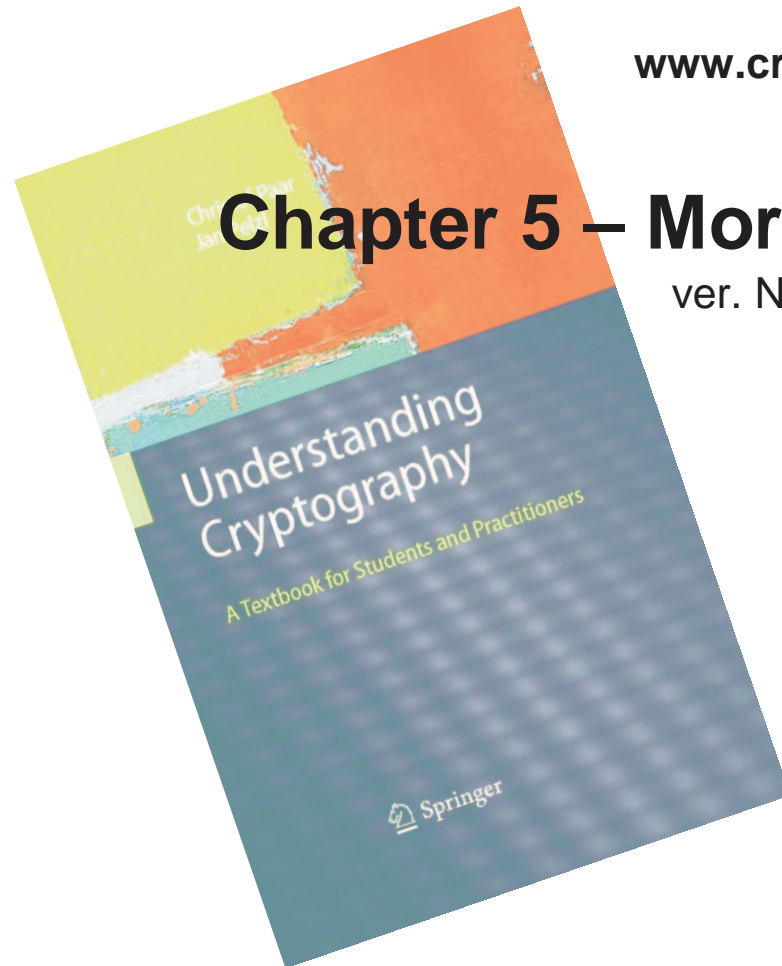

Chapter 5 – More About Block Ciphers

ver. November 26, 2010

These slides were prepared by Amir Moradi, Christof Paar and Jan Pelzl

Some legal stuff (sorry): Terms of Use

- The slides can be used free of charge. All copyrights for the slides remain with Christof Paar and Jan Pelzl.
- The title of the accompanying book “Understanding Cryptography” by Springer and the author’s names must remain on each slide.
- If the slides are modified, appropriate credits to the book authors and the book title must remain within the slides.
- It is not permitted to reproduce parts or all of the slides in printed form whatsoever without written consent by the authors.

Content of this Chapter

- Encryption with Block Ciphers: Modes of Operation
 - Electronic Code Book mode (ECB)
 - Cipher Block Chaining mode (CBC)
 - Output Feedback mode (OFB)
 - Cipher Feedback mode (CFB)
 - Counter mode (CTR)
 - Galois Counter Mode (GCM)
- Exhaustive Key Search Revisited
- Increasing the Security of Block Ciphers

■ Block Ciphers

- A block cipher is much more than just an encryption algorithm, it can be used ...
 - to build different types of block-based encryption schemes
 - to realize stream ciphers
 - to construct hash functions
 - to make message authentication codes
 - to build key establishment protocols
 - to make a pseudo-random number generator
 - ...
- The security of block ciphers also can be increased by
 - key whitening
 - multiple encryption

Content of this Chapter

- **Encryption with Block Ciphers: Modes of Operation**
 - Electronic Code Book mode (ECB)
 - Cipher Block Chaining mode (CBC)
 - Output Feedback mode (OFB)
 - Cipher Feedback mode (CFB)
 - Counter mode (CTR)
 - Galois Counter Mode (GCM)
- Exhaustive Key Search Revisited
- Increasing the Security of Block Ciphers

■ Encryption with Block Ciphers

- There are several ways of encrypting long plaintexts, e.g., an e-mail or a computer file, with a block cipher (“modes of operation”)
 - Electronic Code Book mode (ECB)
 - Cipher Block Chaining mode (CBC)
 - Output Feedback mode (OFB)
 - Cipher Feedback mode (CFB)
 - Counter mode (CTR)
 - Galois Counter Mode (GCM)
- All of the 6 modes have one goal:
 - In addition to confidentiality, they provide authenticity and integrity:
 - Is the message really coming from the original sender? (authenticity)
 - Was the ciphertext altered during transmission? (integrity)

Content of this Chapter

- **Encryption with Block Ciphers: Modes of Operation**
 - **Electronic Code Book mode (ECB)**
 - Cipher Block Chaining mode (CBC)
 - Output Feedback mode (OFB)
 - Cipher Feedback mode (CFB)
 - Counter mode (CTR)
 - Galois Counter Mode (GCM)
- Exhaustive Key Search Revisited
- Increasing the Security of Block Ciphers

■ Electronic Code Book mode (ECB)

- $e_k(x_i)$ denote the encryption of a b -bit plaintext block x_i with key k
- $e_k^{-1}(y_i)$ denote the decryption of b -bit ciphertext block y_i with key k
- Messages which exceed b bits are partitioned into b -bit blocks
- **Each Block is encrypted separately**

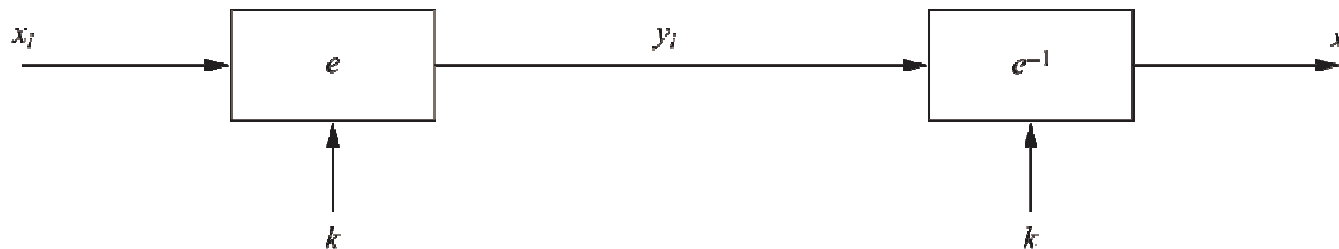

Encryption: $y_i = e_k(x_i), i \geq 1$

Decryption: $x_i = e_k^{-1}(y_i) = e_k^{-1}(e_k(x_i)), i \geq 1$

■ ECB: advantages/disadvantages

- Advantages
 - no block synchronization between sender and receiver is required
 - bit errors caused by noisy channels only affect the corresponding block but not succeeding blocks
 - Block cipher operating can be parallelized
 - advantage for high-speed implementations
- Disadvantages
 - ECB encrypts highly deterministically
 - identical plaintexts result in identical ciphertexts
 - an attacker recognizes if the same message has been sent twice
 - plaintext blocks are encrypted independently of previous blocks
 - an attacker may reorder ciphertext blocks which results in valid plaintext

■ Substitution Attack on ECB

- Once a particular plaintext to ciphertext block mapping $x_i \rightarrow y_i$ is known, a sequence of ciphertext blocks can easily be manipulated
- Suppose an *electronic bank transfer*

Block #	1	2	3	4	5
	Sending Bank A	Sending Account #	Receiving Bank B	Receiving Account #	Amount \$

- the encryption key between the two banks does not change too frequently
- The attacker sends \$1.00 transfers from his account at bank A to his account at bank B repeatedly
 - He can check for ciphertext blocks that repeat, and he stores blocks 1,3 and 4 of these transfers
- He now simply replaces block 4 of other transfers with the block 4 that he stored before
 - *all transfers* from some account of bank A to some account of bank B are redirected to go into the attacker's B account!

■ Example of encrypting bitmaps in ECB mode

- Identical plaintexts are mapped to identical ciphertexts

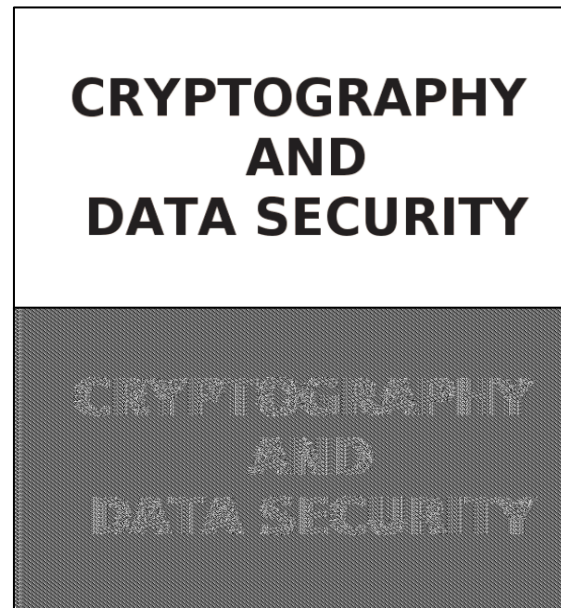

- Statistical properties in the plaintext are preserved in the ciphertext

Content of this Chapter

- **Encryption with Block Ciphers: Modes of Operation**
 - Electronic Code Book mode (ECB)
 - **Cipher Block Chaining mode (CBC)**
 - Output Feedback mode (OFB)
 - Cipher Feedback mode (CFB)
 - Counter mode (CTR)
 - Galois Counter Mode (GCM)
- Exhaustive Key Search Revisited
- Increasing the Security of Block Ciphers

■ Cipher Block Chaining mode (CBC)

- There are two main ideas behind the CBC mode:
 - The encryption of all blocks are “chained together”
 - ciphertext y_i depends not only on block x_i but on all previous plaintext blocks as well
 - The encryption is randomized by using an initialization vector (IV)

Encryption (first block): $y_1 = e_k(x_1 \oplus \text{IV})$

Encryption (general block): $y_i = e_k(x_i \oplus y_{i-1}), i \geq 2$

Decryption (first block): $x_1 = e_k^{-1}(y_1) \oplus \text{IV}$

Decryption (general block): $x_i = e_k^{-1}(y_i) \oplus y_{i-1}, i \geq 2$

■ Cipher Block Chaining mode (CBC)

- For the first plaintext block x_1 there is no previous ciphertext
 - an IV is added to the first plaintext to make each CBC encryption nondeterministic
 - the first ciphertext y_1 depends on plaintext x_1 and the IV
- The second ciphertext y_2 depends on the IV, x_1 and x_2
- The third ciphertext y_3 depends on the IV and x_1, x_2 and x_3 , and so on

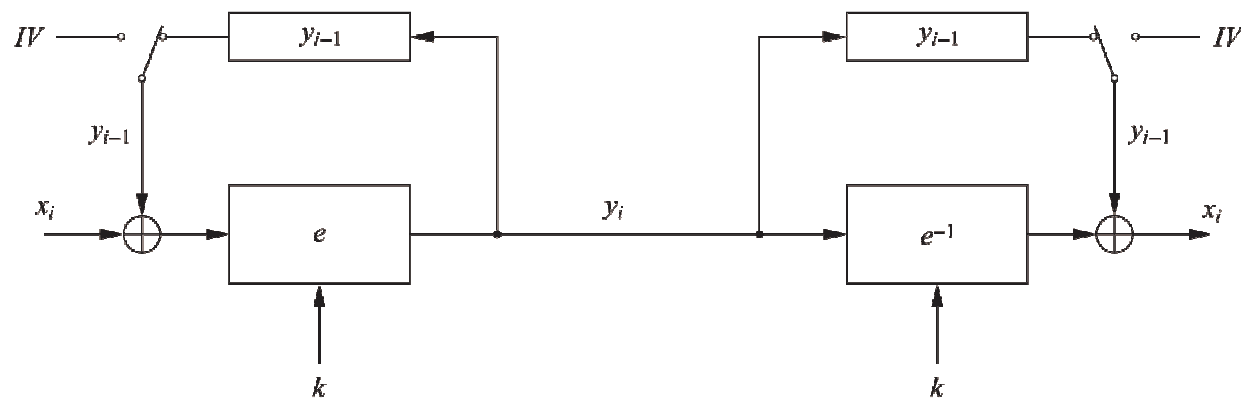

■ Substitution Attack on CBC

- Suppose the last example (*electronic bank transfer*)
- If the IV is properly chosen for every wire transfer, the attack will not work at all
- If the IV is kept the same for several transfers, the attacker would recognize the transfers from his account at bank A to bank B
- If we choose a new IV every time we encrypt, the CBC mode becomes a probabilistic encryption scheme, i.e., two encryptions of the same plaintext look entirely different
- It is not needed to keep the IV *secret!*
- Typically, the IV should be a non-secret nonce (value used only once)

Content of this Chapter

- **Encryption with Block Ciphers: Modes of Operation**
 - Electronic Code Book mode (ECB)
 - Cipher Block Chaining mode (CBC)
 - **Output Feedback mode (OFB)**
 - Cipher Feedback mode (CFB)
 - Counter mode (CTR)
 - Galois Counter Mode (GCM)
- Exhaustive Key Search Revisited
- Increasing the Security of Block Ciphers

■ Output Feedback mode (OFB)

- It is used to build a *synchronous stream cipher* from a block cipher
- The key stream is not generated bitwise but instead in a blockwise fashion
- The output of the cipher gives us key stream bits S_i with which we can encrypt plaintext bits using the XOR operation

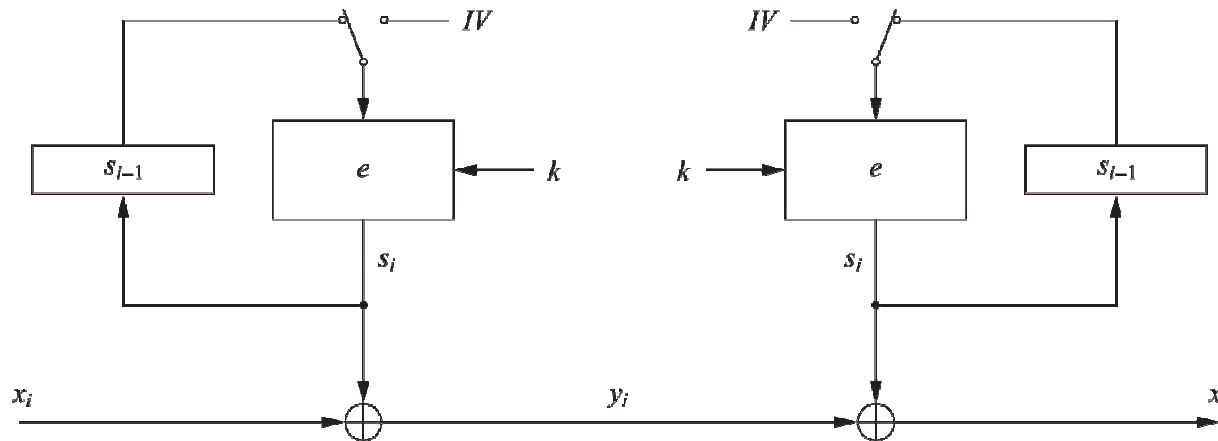

Encryption (first block): $s_1 = e_k(IV)$ and $y_1 = s_1 \oplus x_1$
Encryption (general block): $s_i = e_k(s_{i-1})$ and $y_i = s_i \oplus x_i$, $i \geq 2$
Decryption (first block): $s_1 = e_k(IV)$ and $x_1 = s_1 \oplus y_1$
Decryption (general block): $s_i = e_k(s_{i-1})$ and $x_i = s_i \oplus y_i$, $i \geq 2$

Content of this Chapter

- **Encryption with Block Ciphers: Modes of Operation**
 - Electronic Code Book mode (ECB)
 - Cipher Block Chaining mode (CBC)
 - Output Feedback mode (OFB)
 - **Cipher Feedback mode (CFB)**
 - Counter mode (CTR)
 - Galois Counter Mode (GCM)
- Exhaustive Key Search Revisited
- Increasing the Security of Block Ciphers

■ Cipher Feedback mode (CFB)

- It uses a block cipher as a building block for an asynchronous **stream cipher** (similar to the OFB mode), more accurate name: “Ciphertext Feedback Mode”
- The key stream S_i is generated in a blockwise fashion and is also a function of the ciphertext
- As a result of the use of an IV, the CFB encryption is also nondeterministic

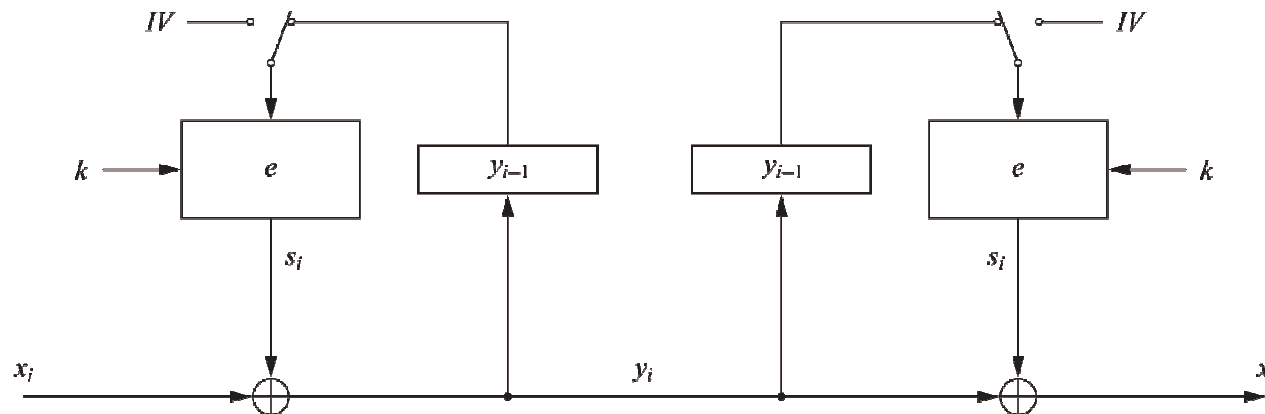

Encryption (first block):	$y_1 = e_k(IV) \oplus x_1$
Encryption (general block):	$y_i = e_k(y_{i-1}) \oplus x_i, \quad i \geq 2$
Decryption (first block):	$x_1 = e_k(IV) \oplus y_1$
Decryption (general block):	$x_i = e_k(y_{i-1}) \oplus y_i, \quad i \geq 2$

- It can be used in situations where short plaintext blocks are to be encrypted

Content of this Chapter

- **Encryption with Block Ciphers: Modes of Operation**
 - Electronic Code Book mode (ECB)
 - Cipher Block Chaining mode (CBC)
 - Output Feedback mode (OFB)
 - Cipher Feedback mode (CFB)
 - **Counter mode (CTR)**
 - Galois Counter Mode (GCM)
- Exhaustive Key Search Revisited
- Increasing the Security of Block Ciphers

■ Counter mode (CTR)

- It uses a block cipher as a **stream cipher** (like the OFB and CFB modes)
- The key stream is computed in a blockwise fashion
- The input to the block cipher is a counter which assumes a different value every time the block cipher computes a new key stream block

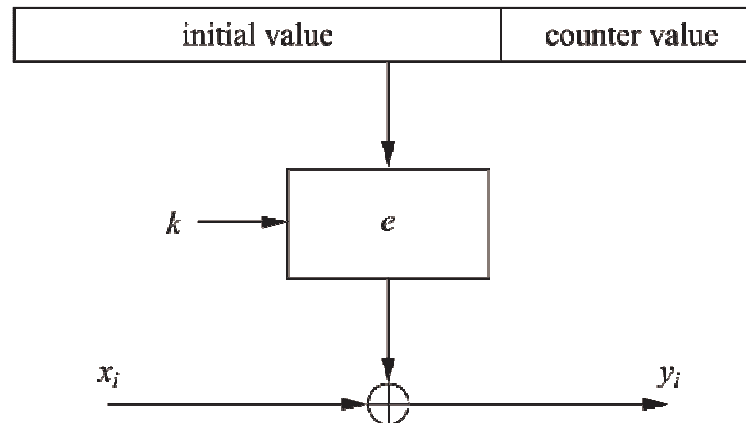

- Unlike CFB and OFB modes, the CTR mode can be parallelized since the 2nd encryption can begin before the 1st one has finished
 - Desirable for high-speed implementations, e.g., in network routers

$$\begin{array}{l} \mathbf{Encryption:} \quad y_i = e_k(\text{IV} \parallel \text{CTR}_i) \oplus x_i \quad i \geq 1 \\ \mathbf{Decryption:} \quad x_i = e_k(\text{IV} \parallel \text{CTR}_i) \oplus y_i \quad i \geq 1 \end{array}$$

Content of this Chapter

- **Encryption with Block Ciphers: Modes of Operation**
 - Electronic Code Book mode (ECB)
 - Cipher Block Chaining mode (CBC)
 - Output Feedback mode (OFB)
 - Cipher Feedback mode (CFB)
 - Counter mode (CTR)
 - **Galois Counter Mode (GCM)**
- Exhaustive Key Search Revisited
- Increasing the Security of Block Ciphers

■ Galois Counter Mode (GCM)

- It also computes a *message authentication code* (MAC), i.e., a cryptographic checksum is computed for a message (for more information see Chapter 12 in *Understanding Cryptography*)
- By making use of GCM, two additional services are provided:
 - Message Authentication
 - the receiver can make sure that the message was really created by the original sender
 - Message Integrity
 - the receiver can make sure that nobody tampered with the ciphertext during transmission

■ Galois Counter Mode (GCM)

- For encryption
 - An initial counter is derived from an IV and a serial number
 - The initial counter value is incremented then encrypted and XORed with the first plaintext block
 - For subsequent plaintexts, the counter is incremented and then encrypted
- For authentication
 - A chained Galois field multiplication is performed (for more information Galois field see Chapter 4.3 in *Understanding Cryptography*)
 - For every plaintext an intermediate authentication parameter g_i is derived
 - g_i is computed as the XOR of the current ciphertext and the last g_{i-1} , and multiplied by the constant H
 - H is generated by encryption of the zero input with the block cipher
 - All multiplications are in the 128-bit Galois field $\text{GF}(2^{128})$

■ Galois Counter Mode (GCM)

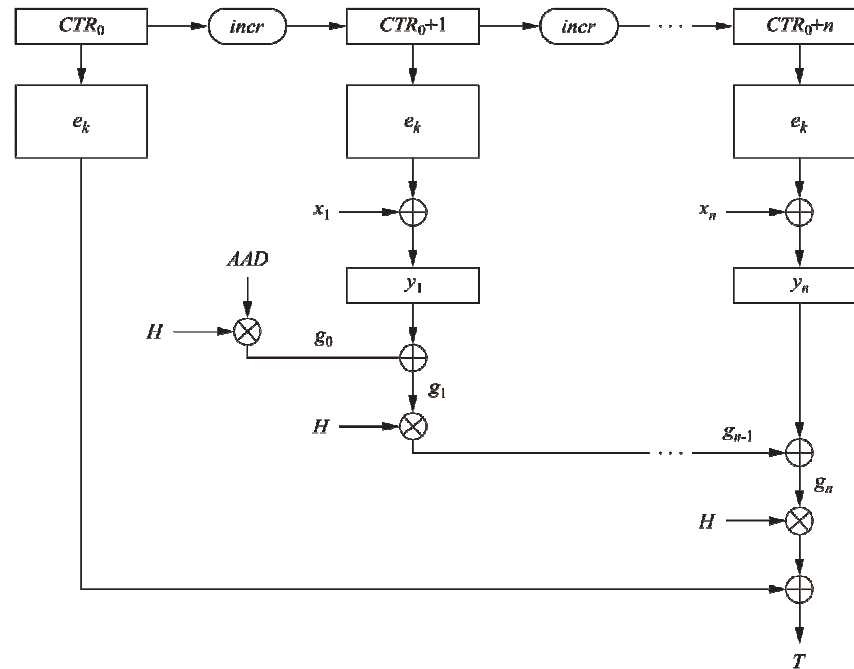

Encryption:

- Derive a counter value CTR_0 from the IV and compute $CTR_1 = CTR_0 + 1$
- Compute ciphertext: $y_i = e_k(CTR_i) \oplus x_i, \quad i \geq 1$

Authentication:

- Generate authentication subkey $H = e_k(0)$
- Compute $g_0 = AAD \times H$ (Galois field multiplication)
- Compute $g_i = (g_{i-1} \oplus y_i) \times H, \quad 1 \leq i \leq n$ (Galois field multiplication)
- Final authentication tag: $T = (g_n \times H) \oplus e_k(CTR_0)$

Content of this Chapter

- Encryption with Block Ciphers: Modes of Operation
- **Exhaustive Key Search Revisited**
- Increasing the Security of Block Ciphers

■ Exhaustive Key Search Revisited

- A simple exhaustive search for a DES key knowing one pair (x_1, y_1) :

$$DES_k^{(i)}(x_1) \stackrel{?}{=} y_1, \quad i = 0, 1, \dots, 2^{56} - 1$$

- However, for most other block ciphers a key search is somewhat more complicated
- A brute-force attack can produce *false positive* results
 - keys k_i that are found are not the one used for the encryption

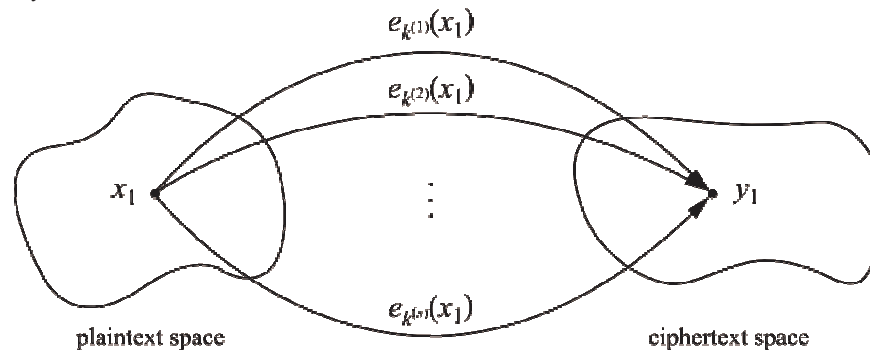

- The likelihood of this is related to the relative size of the key space and the plaintext space
- A brute-force attack is still *possible*, but several pairs of plaintext–ciphertext are needed

■ An Exhaustive Key Search Example

- Assume a cipher with a block width of 64 bit and a key size of 80 bit
- If we encrypt x_1 under all possible 2^{80} keys, we obtain 2^{80} ciphertexts
 - However, there exist only 2^{64} different ones
- If we run through all keys for a given plaintext–ciphertext pair, we find on average $2^{80}/2^{64} = 2^{16}$ keys that perform the mapping $e_k(x_1) = y_1$

Given a block cipher with a key length of k bits and block size of n bits, as well as t plaintext–ciphertext pairs $(x_1, y_1), \dots, (x_t, y_t)$, the expected number of *false* keys which encrypt all plaintexts to the corresponding ciphertexts is:

$$2^{k-tn}$$

- In this example assuming two plaintext-ciphertext pairs, the likelihood is

$$2^{80-2 \cdot 64} = 2^{-48}$$

- for almost all practical purposes two plaintext-ciphertext pairs are sufficient

Content of this Chapter

- Encryption with Block Ciphers: Modes of Operation
- Exhaustive Key Search Revisited
- **Increasing the Security of Block Ciphers**
 - Double Encryption and Meet-in-the-Middle Attack
 - Triple Encryption
 - Key Whitening

■ Increasing the Security of Block Ciphers

- In some situations we wish to increase the security of block ciphers, e.g., if a cipher such as DES is available in hardware or software for legacy reasons in a given application
- Two approaches are possible
 - Multiple encryption
 - theoretically much more secure, but **sometimes** in practice increases the security very little
 - Key whitening

Content of this Chapter

- Encryption with Block Ciphers: Modes of Operation
- Exhaustive Key Search Revisited
- **Increasing the Security of Block Ciphers**
 - **Double Encryption and Meet-in-the-Middle Attack**
 - Triple Encryption
 - Key Whitening

■ Double Encryption

- A plaintext x is first encrypted with a key k_L , and the resulting ciphertext is encrypted again using a second key k_R

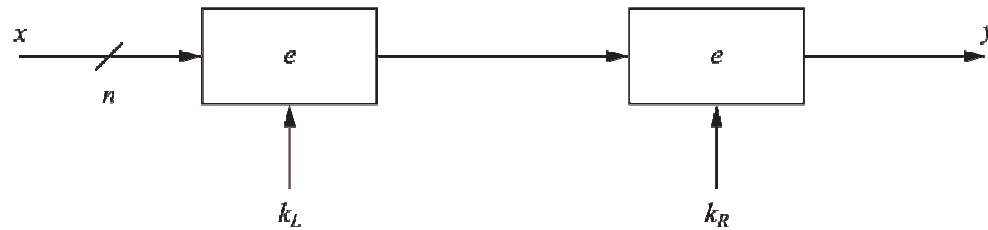

- Assuming a key length of k bits, an exhaustive key search would require $2^k \cdot 2^k = 2^{2k}$ encryptions or decryptions

■ Meet-in-the-Middle Attack

- A Meet-in-the-Middle attack requires $2^k + 2^k = 2^{k+1}$ operations!

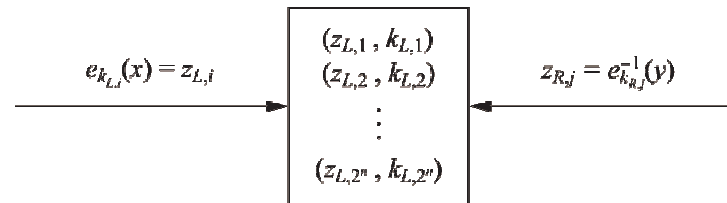

- **Phase I:** for the given (x_1, y_1) the **left** encryption is brute-forced for all $k_{L,i}$, $i=1,2, \dots, 2^k$ and a lookup table with 2^k entry (each $n+k$ bits wide) is computed
 - the lookup table should be ordered by the result of the encryption ($z_{L,i}$)
- **Phase II:** the **right** encryption is brute-forced (using decryption) and for each $z_{R,i}$ it is checked whether $z_{R,i}$ is equal to any $z_{L,i}$ value in the table of the first phase
- Computational Complexity

$$\begin{aligned} \text{number of encryptions and decryptions} &= 2^k + 2^k = 2^{k+1} \\ \text{number of storage locations} &= 2^k \end{aligned}$$

- **Double encryption is not much more secure than single encryption!**

Content of this Chapter

- Encryption with Block Ciphers: Modes of Operation
- Exhaustive Key Search Revisited
- **Increasing the Security of Block Ciphers**
 - Double Encryption and Meet-in-the-Middle Attack
 - **Triple Encryption**
 - Key Whitening

■ Triple Encryption

- The encryption of a block three times $y = e_{k_3}(e_{k_2}(e_{k_1}(x)))$
- In practice a variant scheme is often used EDE (encryption-decryption-encryption)

$$y = e_{k_3}(e_{k_2}^{-1}(e_{k_1}(x)))$$

- Advantage: choosing $k_1=k_2=k_3$ performs single DES encryption
- Still we can perform a meet-in-the middle attack, and it reduces the *effective key length* of triple encryption from $3K$ to $2K$!
 - The attacker must run 2^{112} tests in the case of 3DES

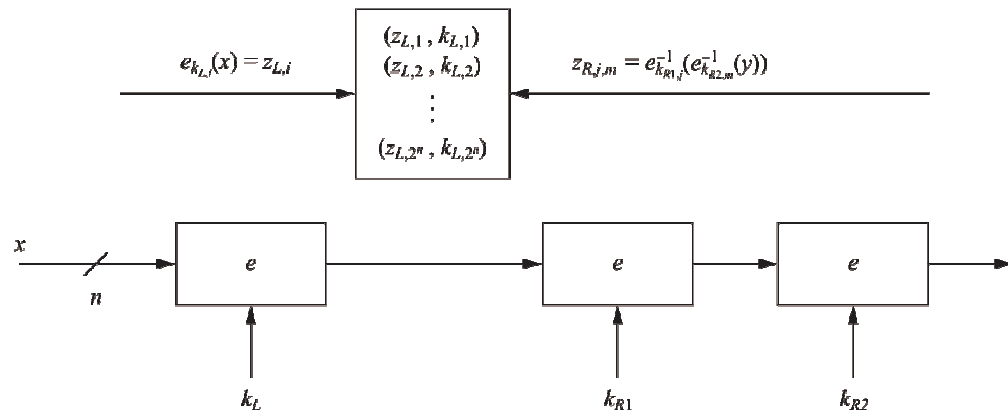

- **Triple encryption effectively doubles the key length**

Content of this Chapter

- Encryption with Block Ciphers: Modes of Operation
- Exhaustive Key Search Revisited
- **Increasing the Security of Block Ciphers**
 - Double Encryption and Meet-in-the-Middle Attack
 - Triple Encryption
 - **Key Whitening**

■ Key Whitening

- Makes block ciphers such as DES much more resistant against brute-force attacks
- In addition to the regular cipher key k , two whitening keys k_1 and k_2 are used to XOR-mask the plaintext and ciphertext

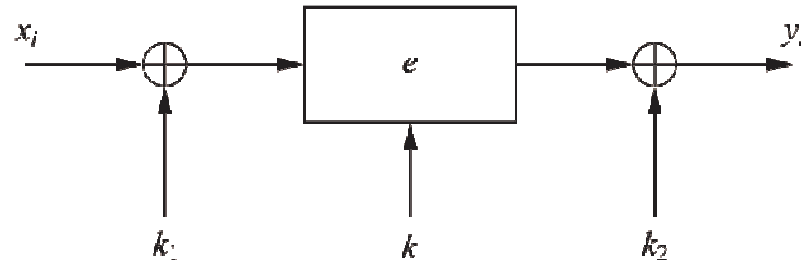

- It does not strengthen block ciphers against most analytical attacks such as linear and differential cryptanalysis
- It is not a “cure” for inherently weak ciphers
- The additional computational load is negligible
- Its main application is ciphers that are relatively strong against analytical attacks but possess too short a key space especially DES
 - a variant of DES which uses key whitening is called DESX

■ Lessons Learned

- There are many different ways to encrypt with a block cipher. Each mode of operation has some advantages and disadvantages
- Several modes turn a block cipher into a stream cipher
- There are modes that perform encryption together together with authentication, i.e., a cryptographic checksum protects against message manipulation
- The straightforward ECB mode has security weaknesses, independent of the underlying block cipher
- The counter mode allows parallelization of encryption and is thus suited for high speed implementations
- Double encryption with a given block cipher only marginally improves the resistance against brute-force attacks
- Triple encryption with a given block cipher roughly *doubles* the key length
- Triple DES (3DES) has an effective key length of 112 bits
- Key whitening enlarges the DES key length without much computational overhead.