



Kuzey Liman

Güney Liman

Tiyatro

Akropolis

TEOS, GEÇ ARKAİK İON TAPINAĞI (MÖ 550-525)

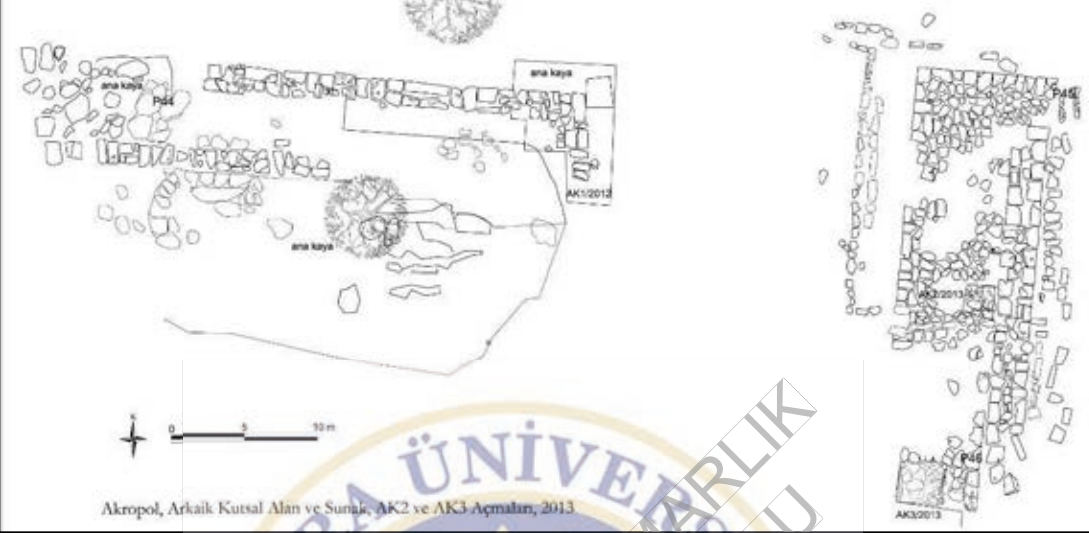

Akropolis, Arkaik Kutsal Alan ve Sunak, AK2 ve AK3 Ağımları, 2013



Teos Akropolisi:
Hekatompedos olarak adlandırılan tapınağın ve altarın kalıntıları





2. Teos. Eckkapitellvolute und Blattkyma

3. Teos. Kapitellfragment,
Echinuskyma

W. Koenigs, Archaische Bauglieder aus Stein in Ionien, in: J. Cobet – V. von Graeve – W.-D. Niemeyer – K. Zimmermann (Hrsg.), Frühes Ionien. Eine Bestandaufnahme. Panionion-Symposium Güzelçamlı 26. September – 1. Oktober 1999 (2007) 669ff. Taf. 89,2-3.

Arkaik Mimari blokların buluntu yerleri



2. Teos. Eckkapitellvolute und Blattkyma

W. Koenigs, Archaische Bauglieder aus Stein in Ionien, in: J. Cobet – V. von Graeve – W.-D. Niemeyer – K. Zimmermann (Hrsg.), Frühes Ionien. Eine Bestandaufnahme. Panionion-Symposion Güzelçamlı 26. September – 1. Oktober 1999 (2007) 669ff. Taf. 89,2.



T2

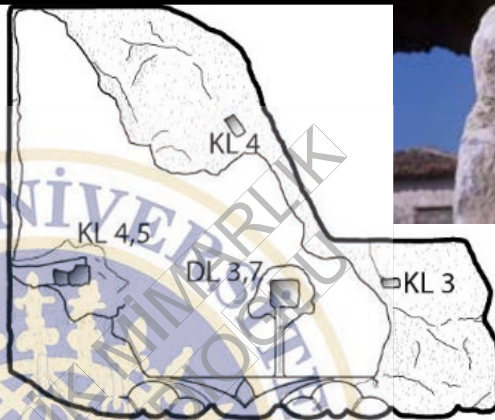

AUFSICHT

57



ANSICHT

18,3

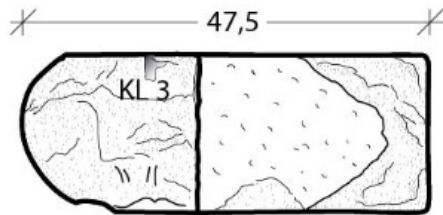

SEITENANSICHT

47,5

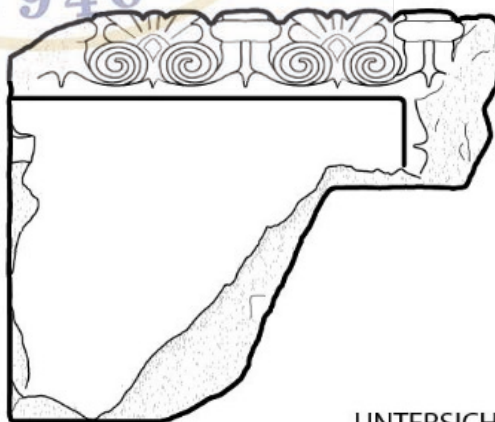

UNTERSICHT

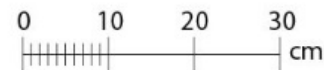

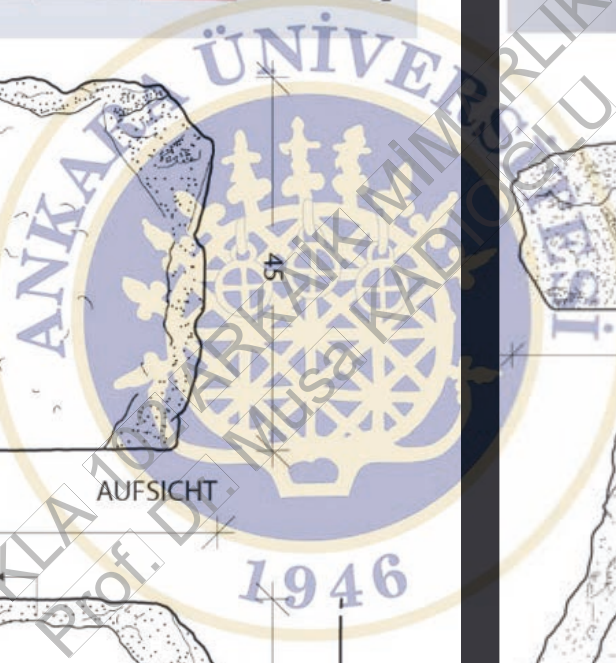
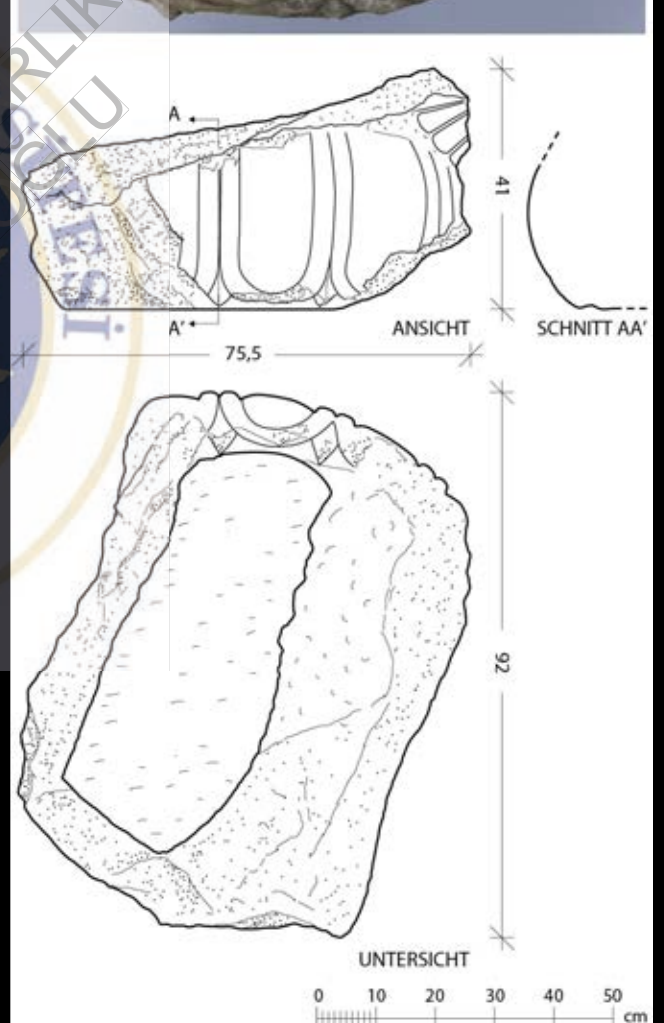
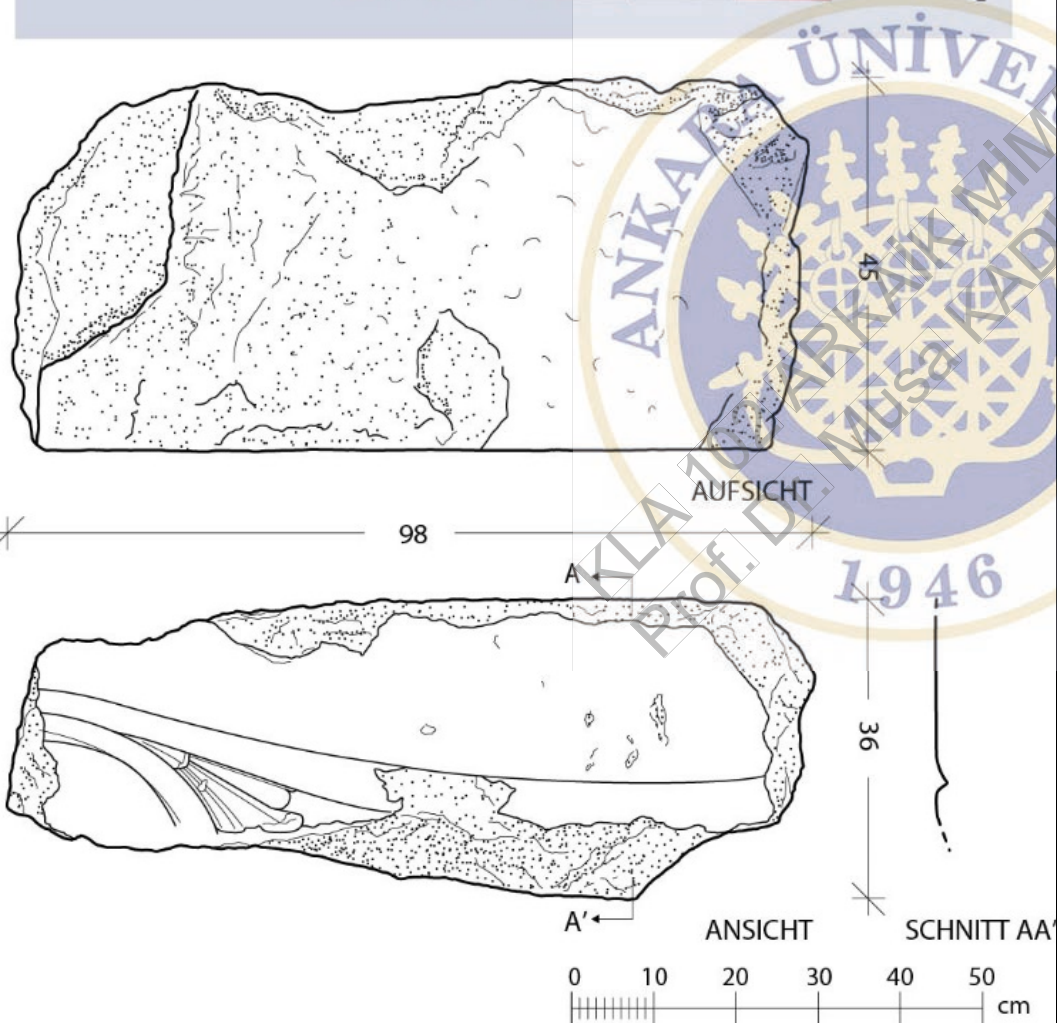

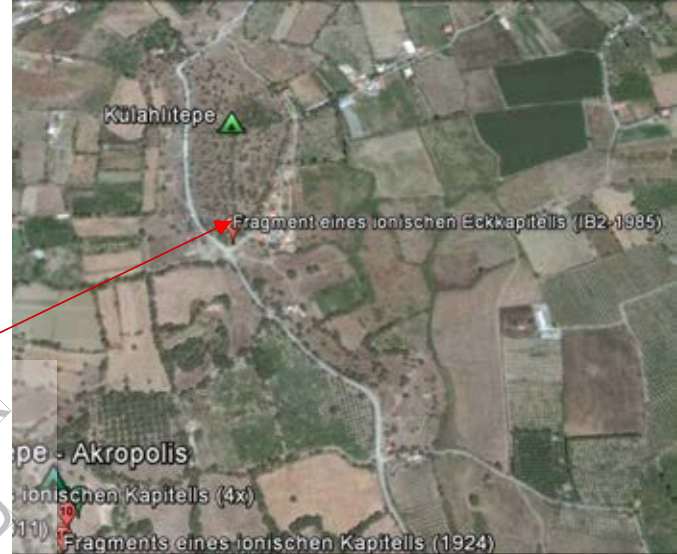

ANKARA ÜNİVERSİTESİ

1946

Prof. Dr. Mustafa KABIOĞLU

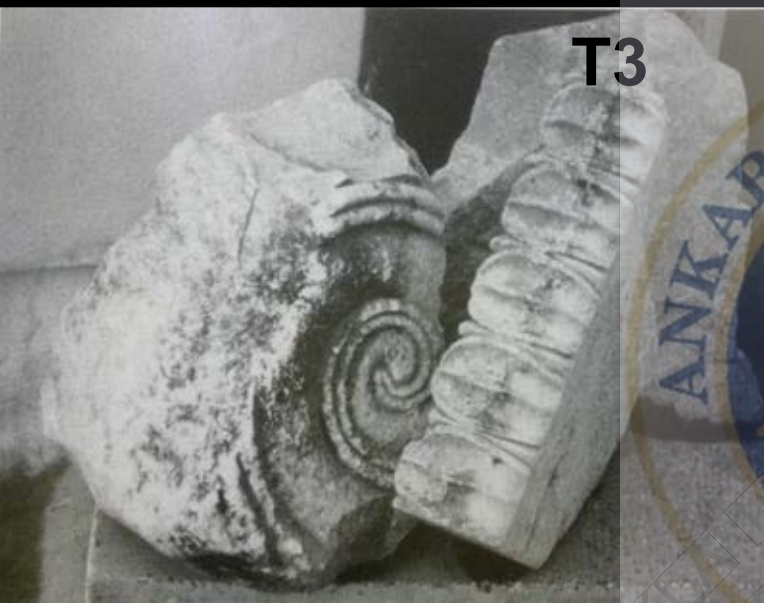

2. Teos. Eckkapitellvolute und Blattkyma

W. Koenigs, Archaische Bauglieder aus Stein in Ionien, in: J. Cobet – V. von Graeve – W.-D. Niemeyer – K. Zimmermann (Hrsg.), Frühes Ionien. Eine Bestandaufnahme. Panionion-Symposium Güzelçamlı 26. September – 1. Oktober 1999 (2007) 669ff. Taf. 89,2.





T3

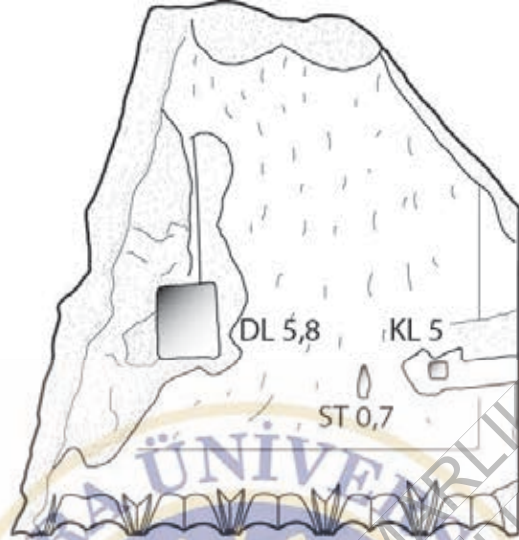

DL 5,8

KL 5

ST 0,7

AUFSICHT

56,6



13,6

ANSICHT

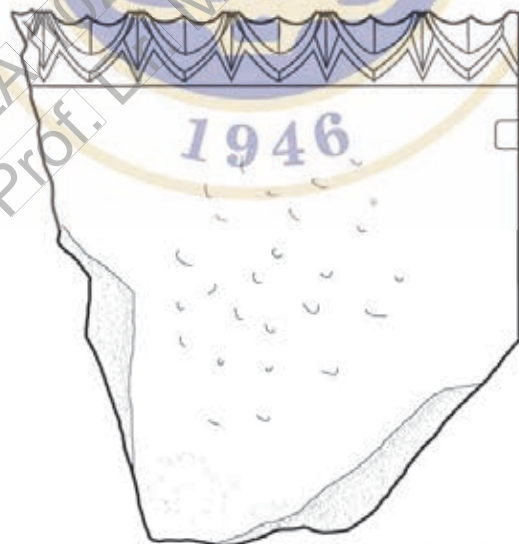

1946

UNTERSICHT

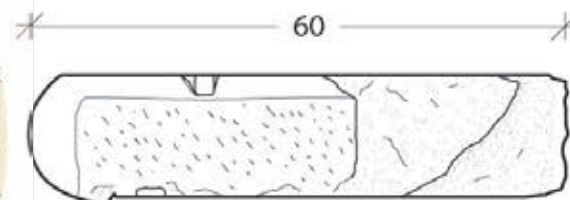

60

SEITENANSICHT



0

10

20

30

40

50

cm

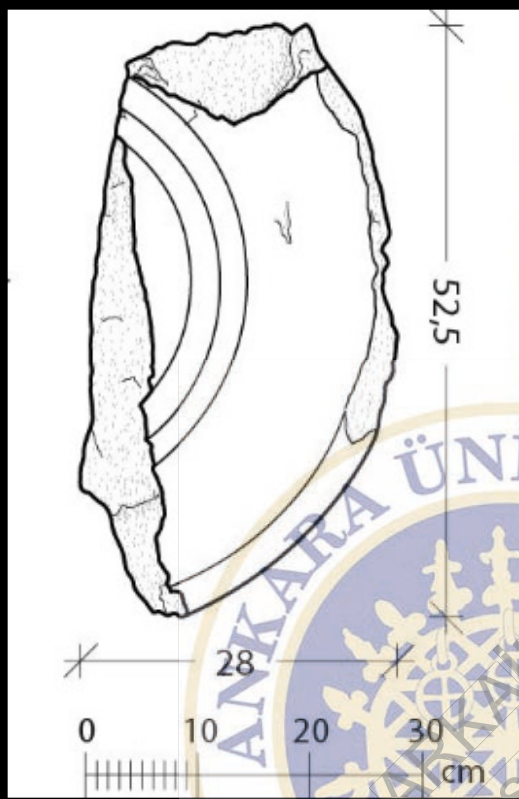



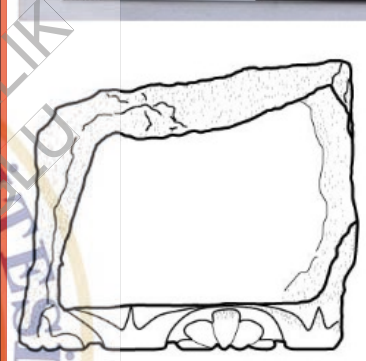

AUSICHT

39,5

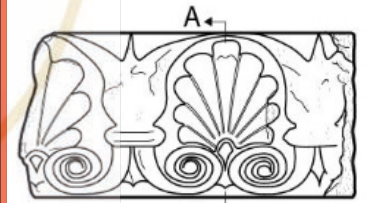
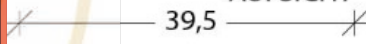

ANSICHT

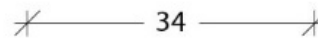

T1

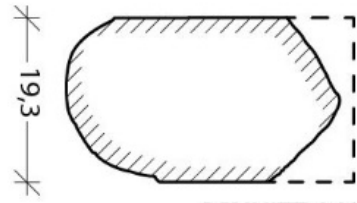

SCHNITT AA'

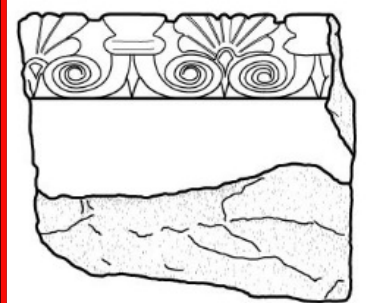
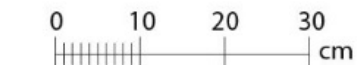
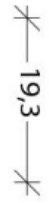

UNTERSICHT



T6

T7

T7





A1 ve F1



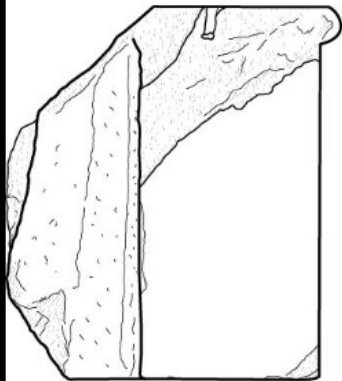

LINKE ANSICHT

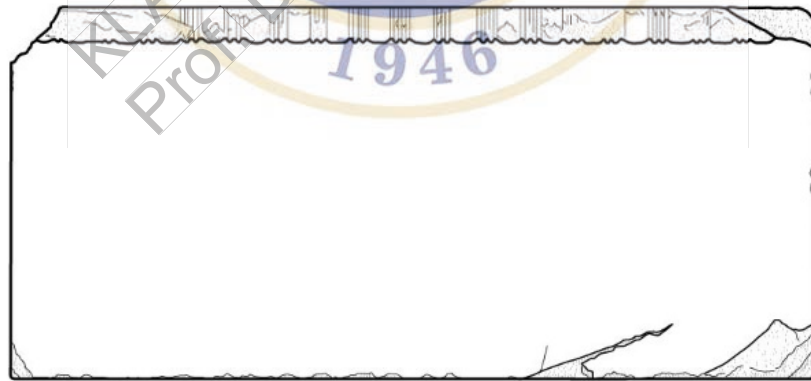

ANSICHT

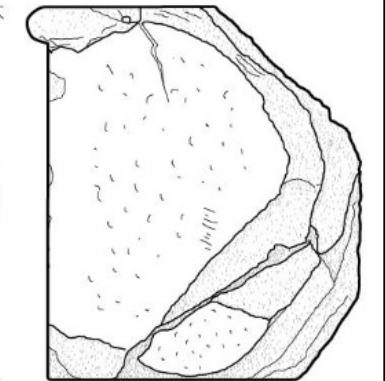

RECHTE ANSICHT

Duvar Arşitravı – Köşe Bloğu (A1) - 2013

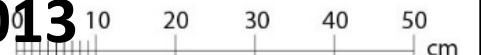

A1



Arka Yüz

A1



Sağ Yanyüz

A1



Sol yan yüz ve blok birleşim yüzeyi



DUVAR FRİZİ (F1) - 2013

F1



AUSICHT



ANSICHT

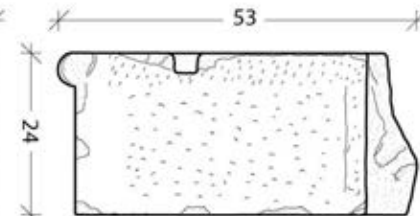

SEITENANSICHT



UNTERSICHT



DUVAR ARŞITRAVI KÖŞE BLOĞU (A1) - 2013

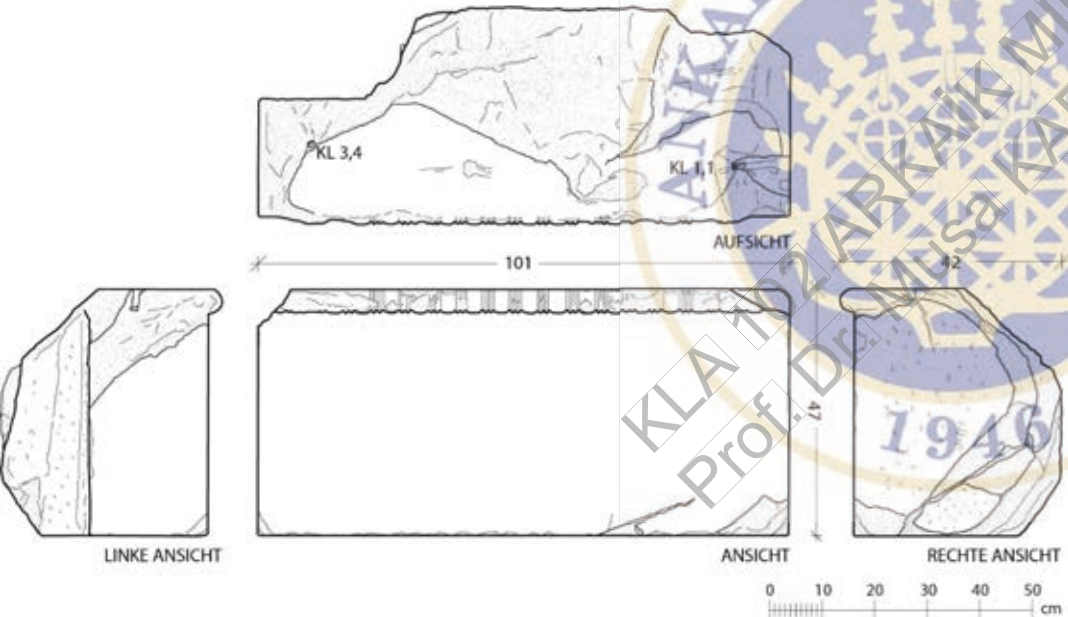

DUVAR FRİZİ (F1) - 2013

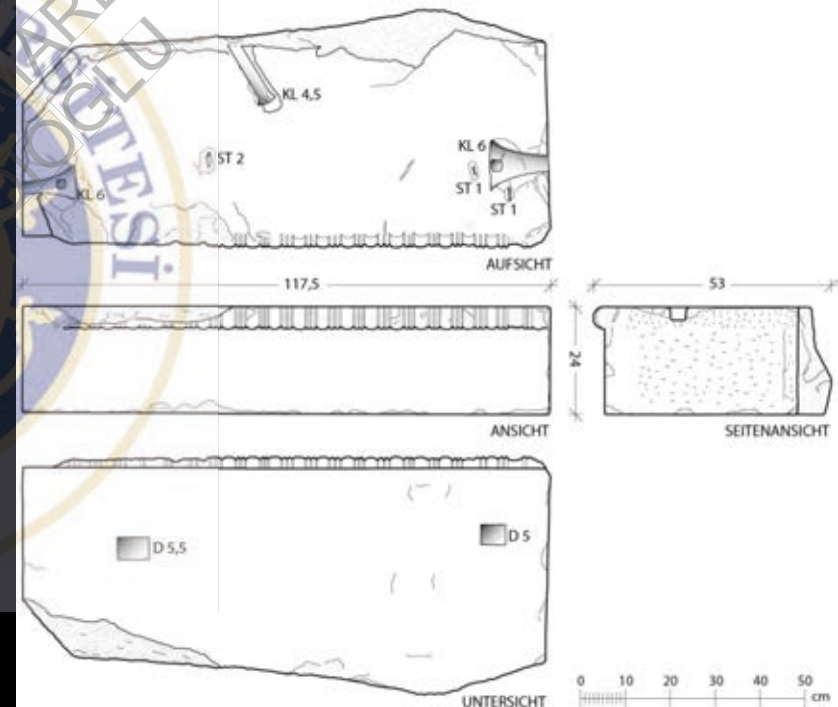



KLA 1
Prof. Dr. Mustafa KABIOĞLU





TEOS



**SIPHNOS
HAZİNE
DAİRESİ**



SAMOS



ANKARA ÜNİVERSİTESİ
MİMARLIK FAKÜLTESİ
1946
KLASİK MİMARLIK
Prof. Dr. ...



MYLASA



TEOS, GEÇ ARKAİK DÖNEM ALTARININ ÜST YAPISI,
(MÖ 6. YY'IN 3. ÇEYREĞİ)





1. Iasos. Ionisches Kyma und Quaderfragmente mit Astragal

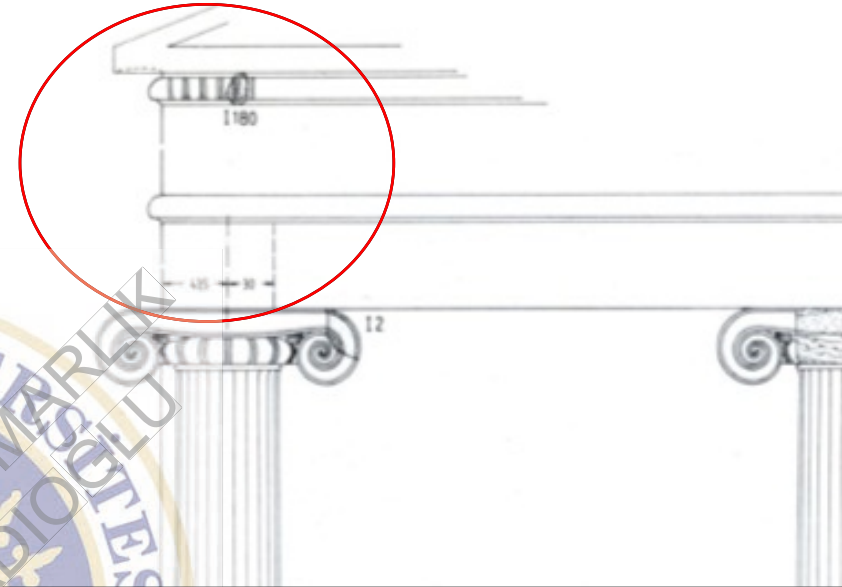
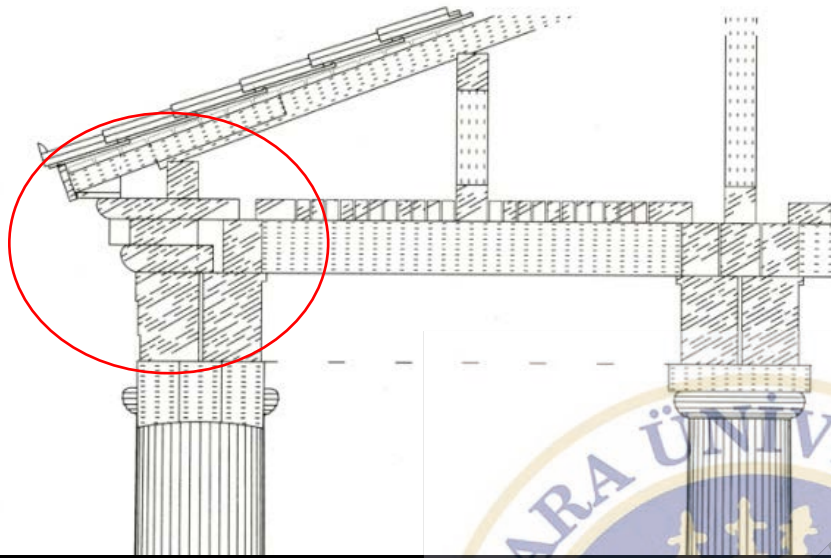

Samos'taki İlk Dipteros'un sütun yüksekliği
önerisinden ayrıntı (MÖ 575-550) Ch. Hendrich, Samon
XXV, 2007, Res. 19



Naxos'taki Iria Dionysos-Kutsal Alanı v (IV); Prostasis'in
Güney Cephe Restitüsyonu (MÖ 580-560) Lambrinoudakis
– Gruben AA 1987, Res. 39; Gruben 2001, Res. 284

İon Başlığının Restitüsyonu

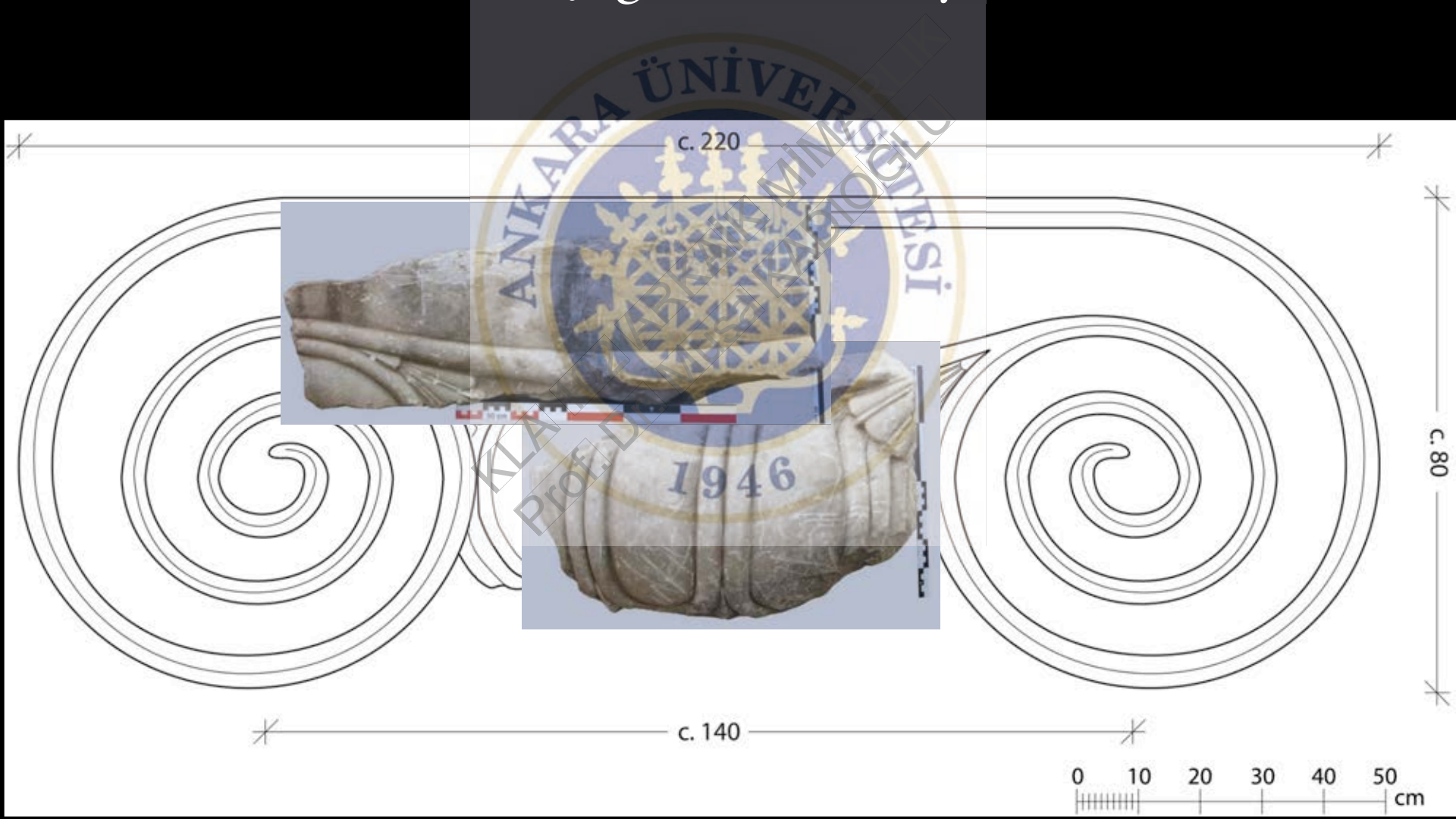

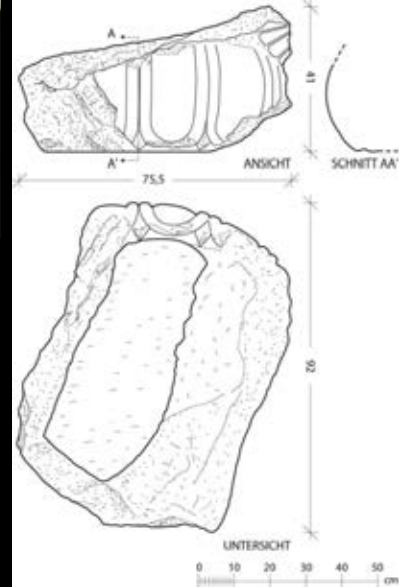
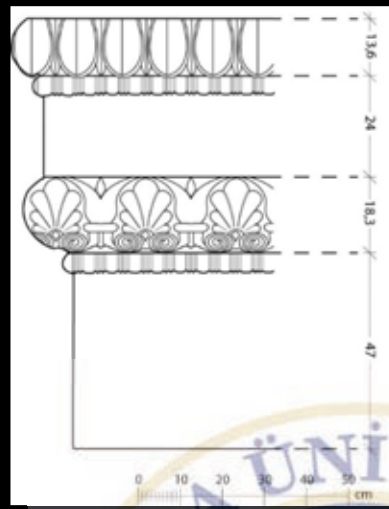

Ohnesorg 2007, Taf. 8 (EPHESOS ARTEMIS TAPINAĞI)

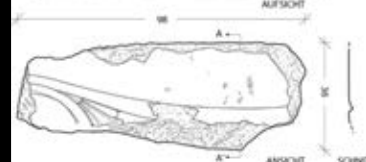
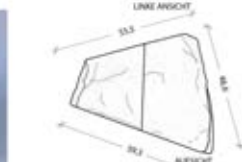
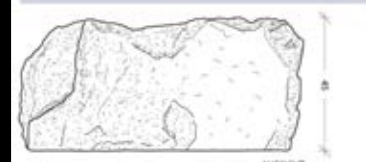
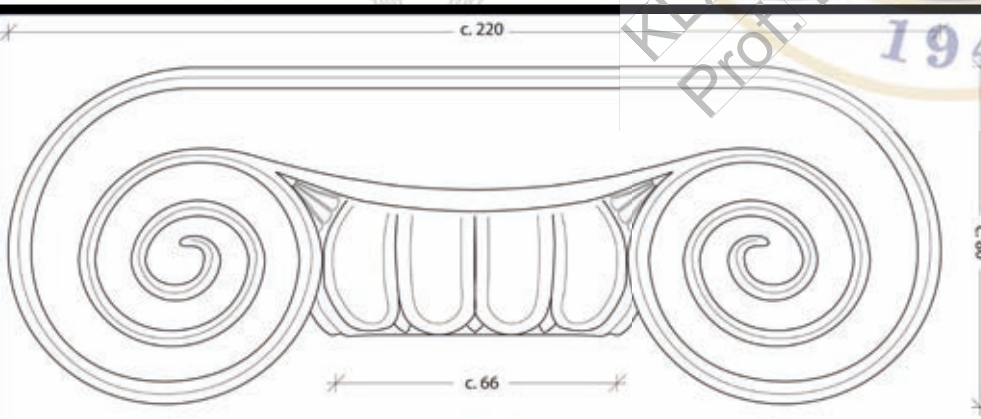
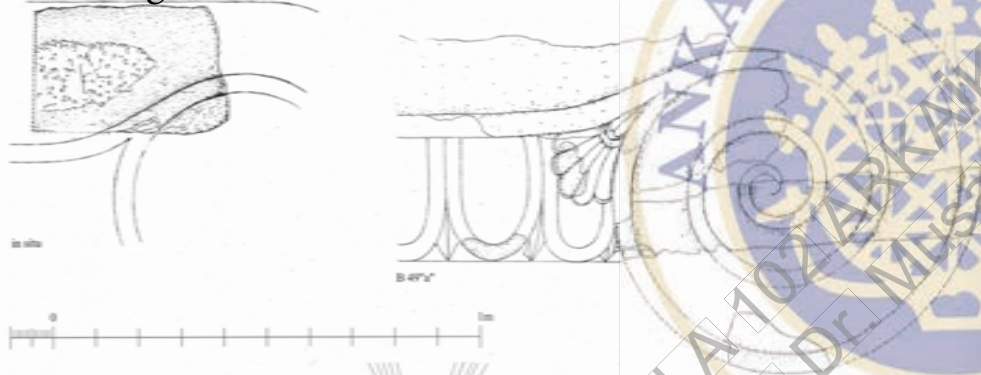

Kadıoğlu ve diğ. 2015, Res. 10-12 (TEOS) MÖ 550-525



Abb. 19. Didyma. Das rekonstruierte Kapitell. Ansichten 1:20

Gruben 1963, Abb. 19

Ohnesorg 2007, Taf. 8

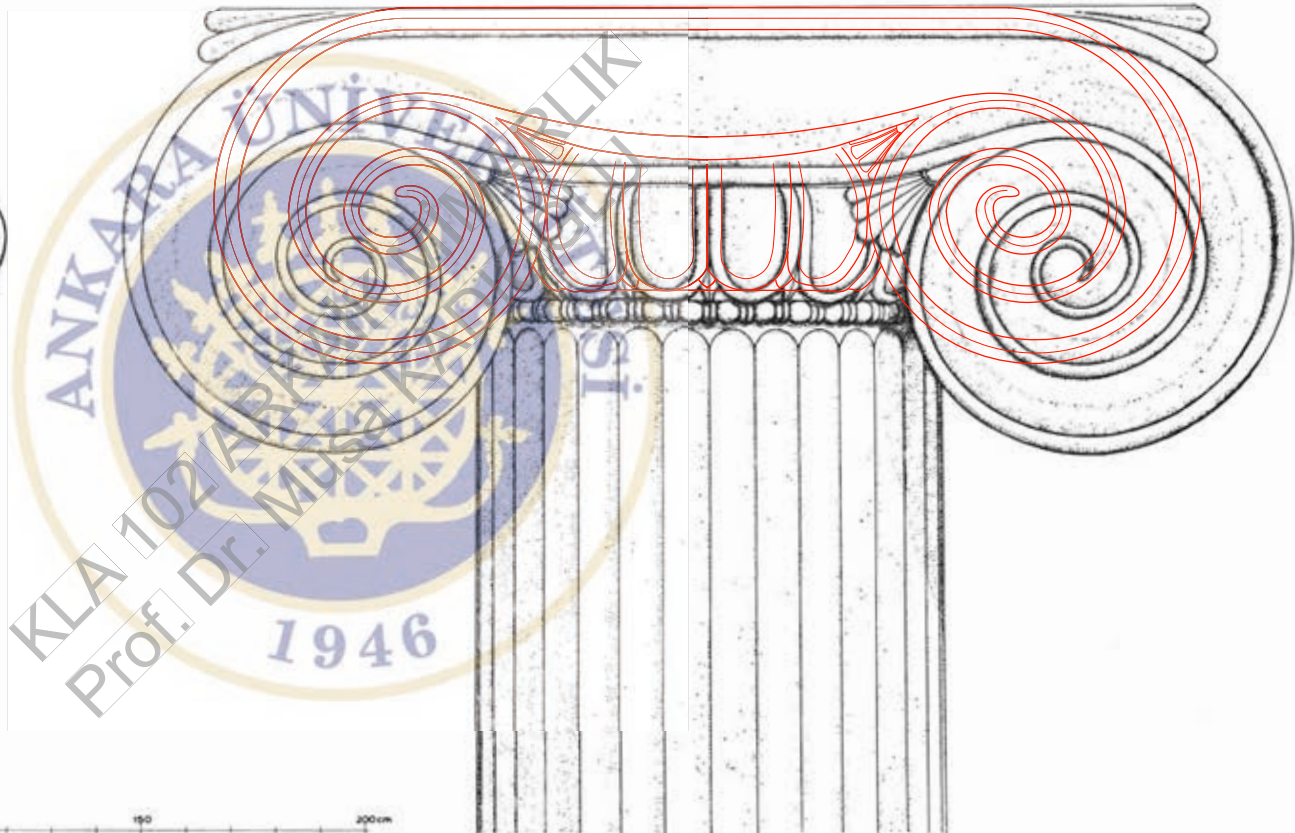
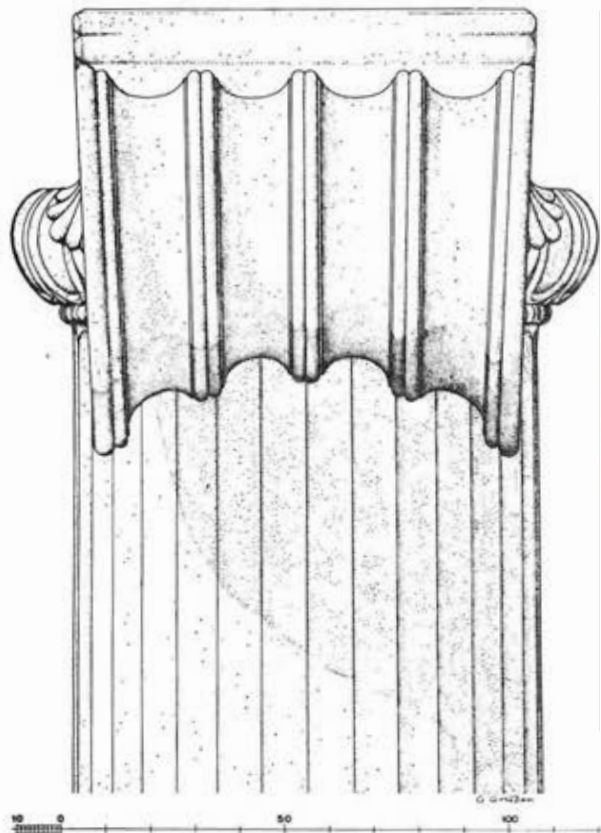
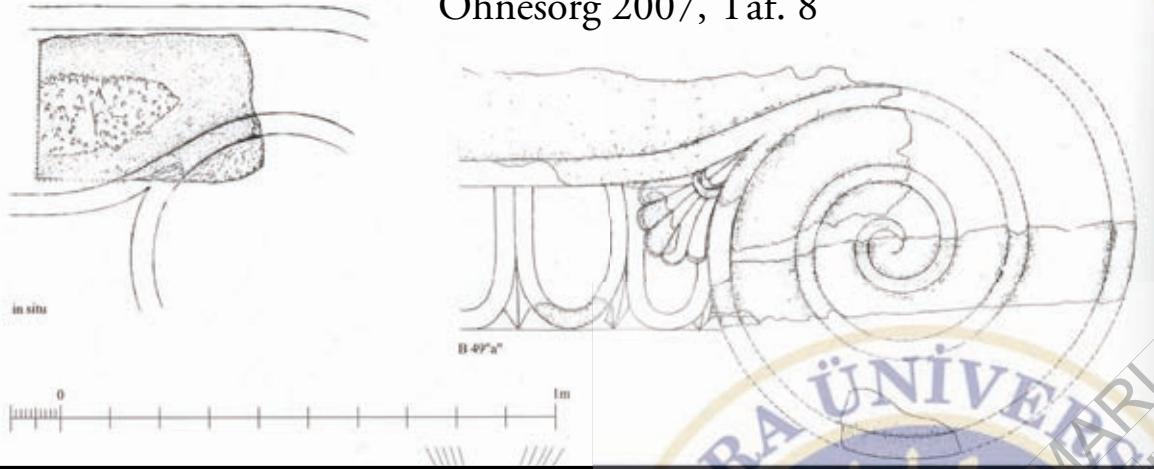

D.B. Wescoat, *The Temple of Athena at Assos* (Oxford 2012) Fig. 26b

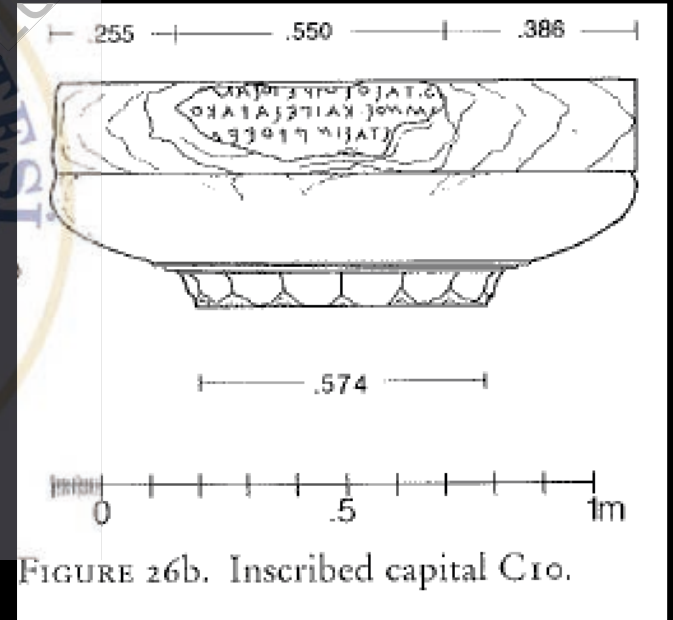
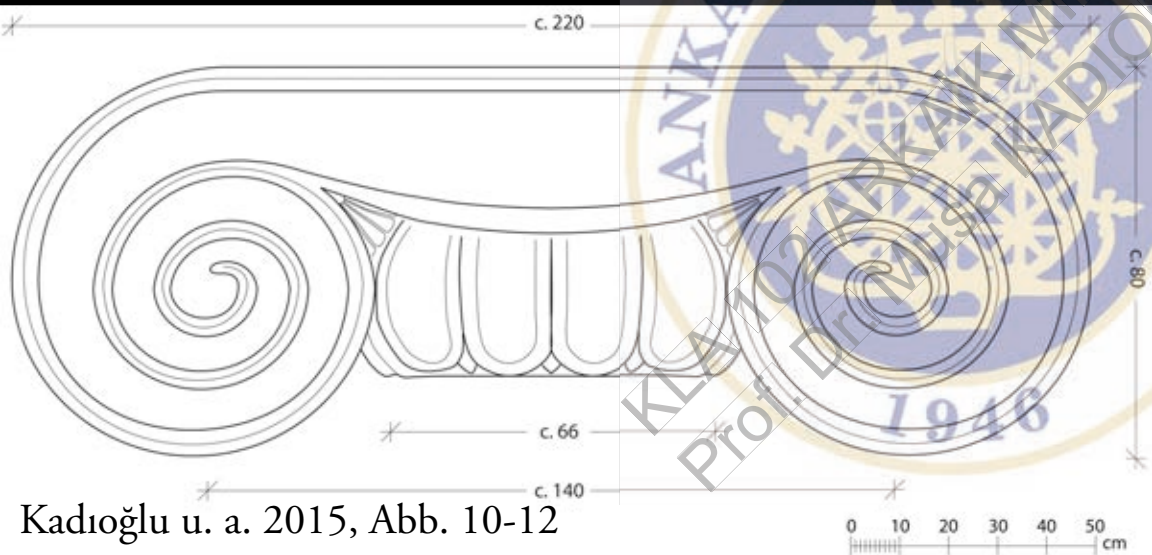

FIGURE 26b. Inscribed capital C10.



Kadıoğlu u. a. 2015, Abb. 10-12

PHOKAIA, ATHENA TAPINAĞI





ANKARA ÜNİVERSİTESİ
1946

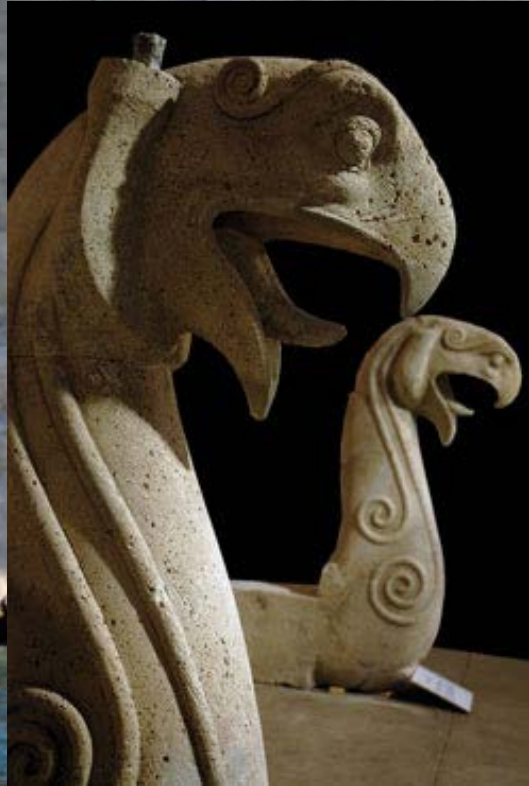







wowTURKEY.com

wowTURKEY.com

wowTURKEY.com



