

BÖLÜM 4 ÇİZİMLERİ DEĞİŞTİRMEK

Çizimleri Seçme

Üzerinde çalışılan karışık bir çizimden sadece belirli nesnelere seçmek için AutoCAD çeşitli seçenekler sunar. Bunların doğru kullanmak çizimleri değiştirirken hızlı ve verimli çalışmak açısından çok önemlidir.

Tek Tek Seçme

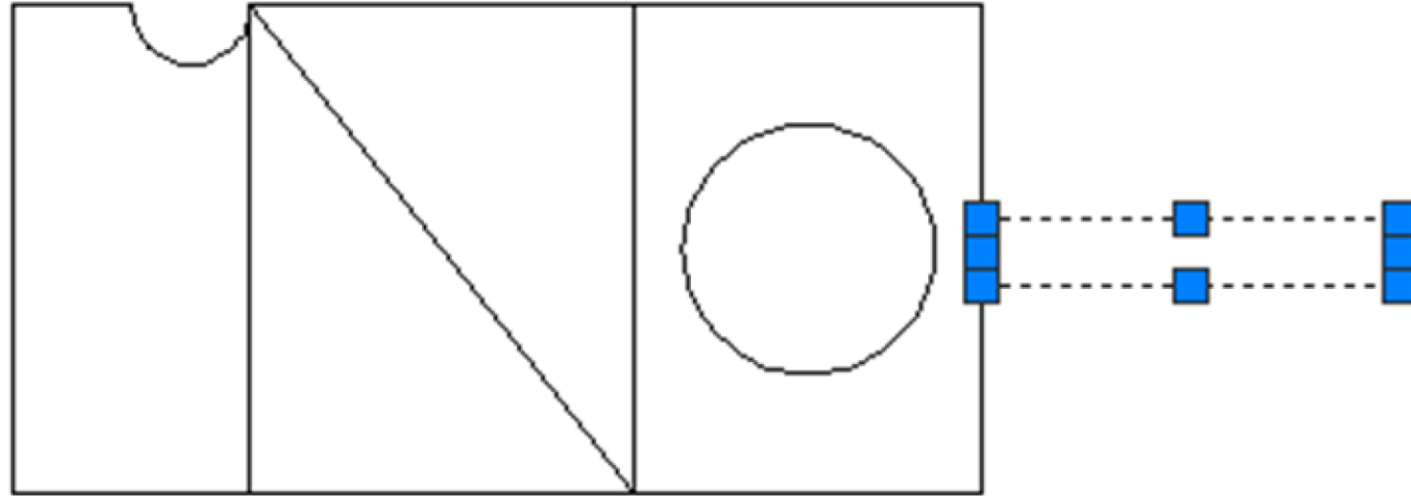

Pencereyle Keserek Seçme

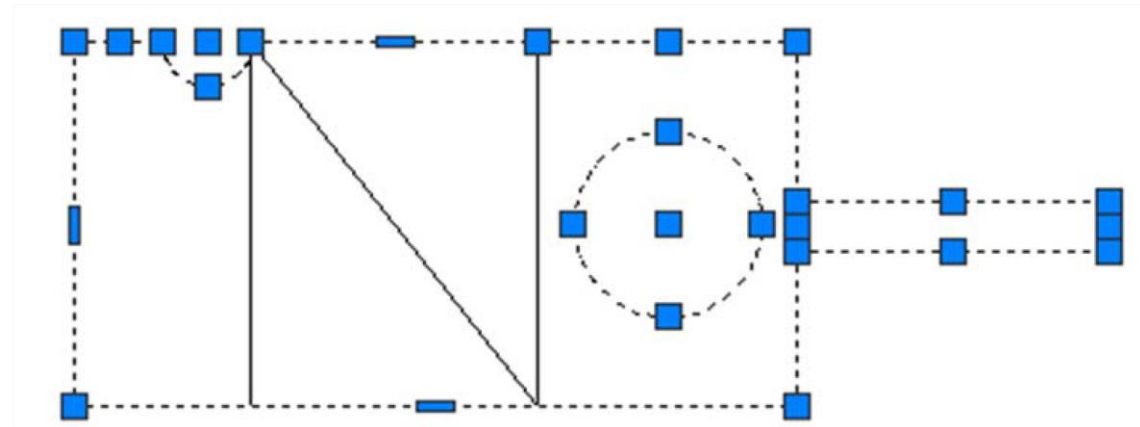
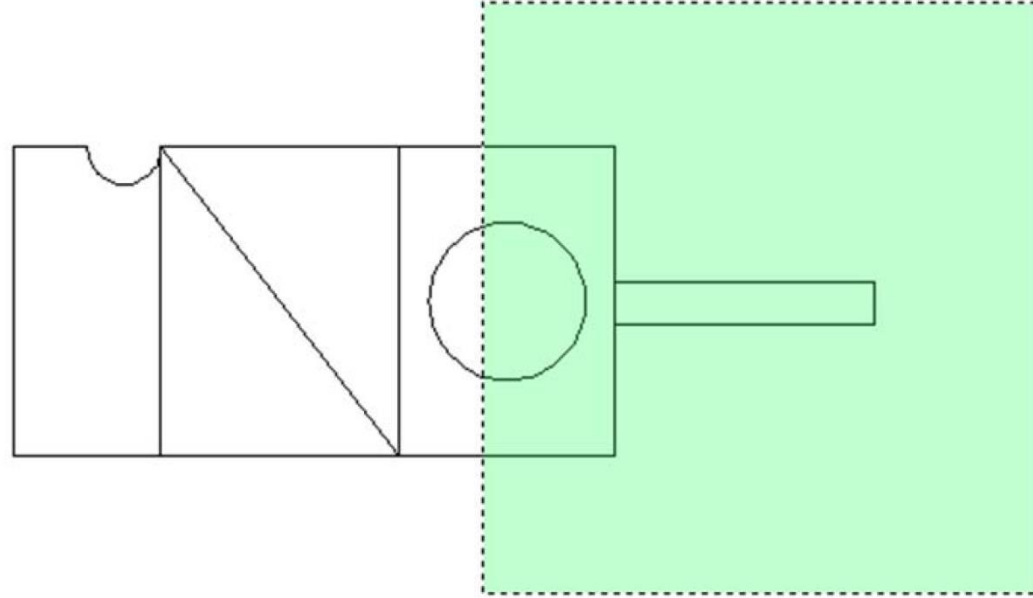

Modify (Değiştirme Paneli)

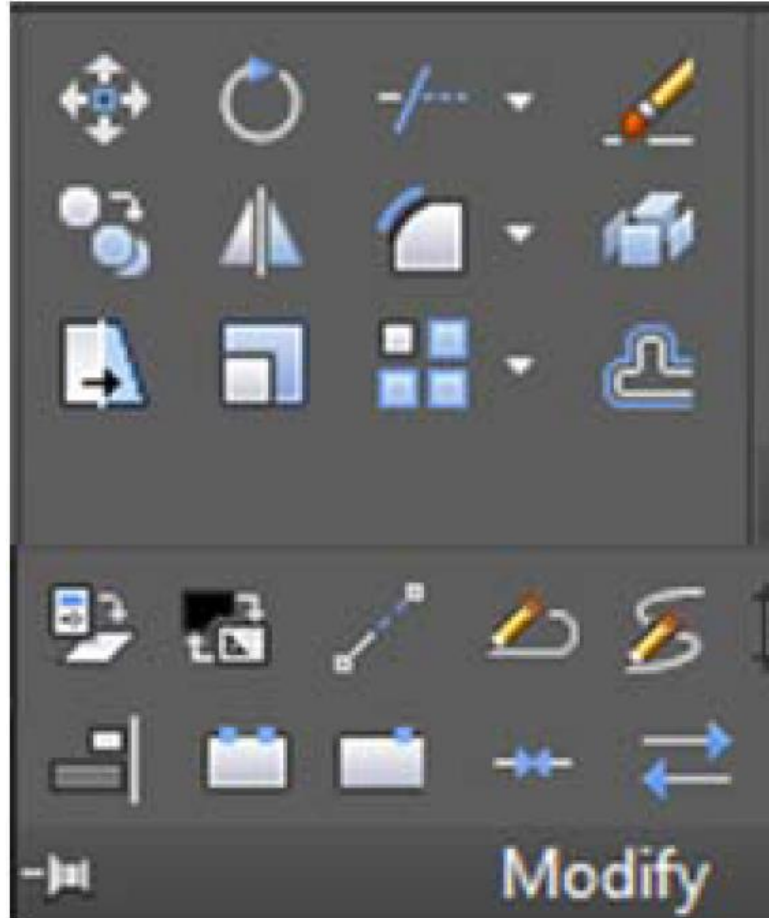

Erase (E) Silme

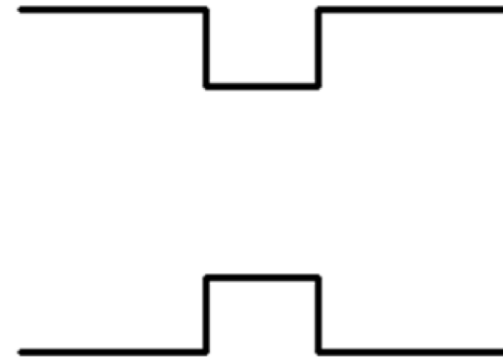
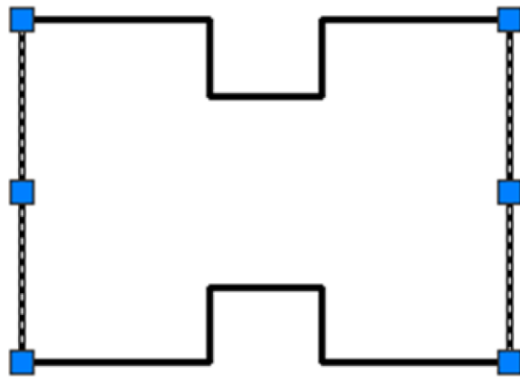
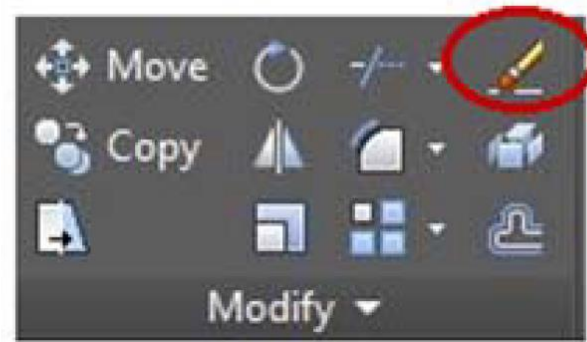

Move (M) Taşıma

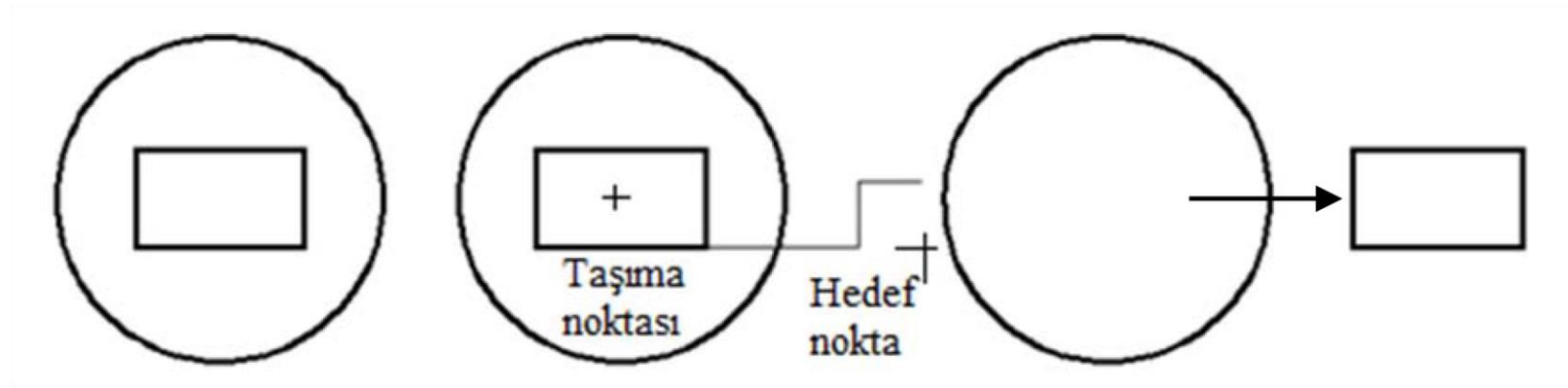
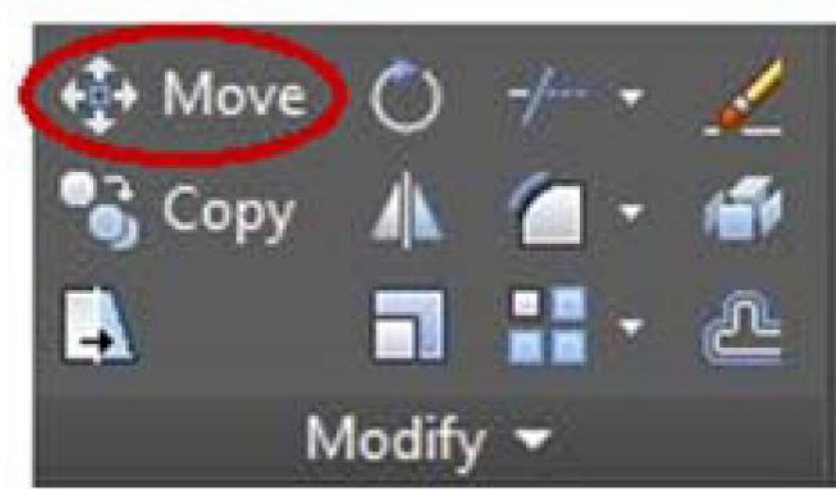

Copy (Co) Kopyalama (Çoğaltma)

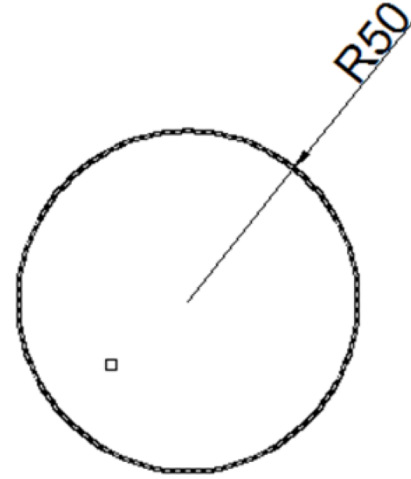
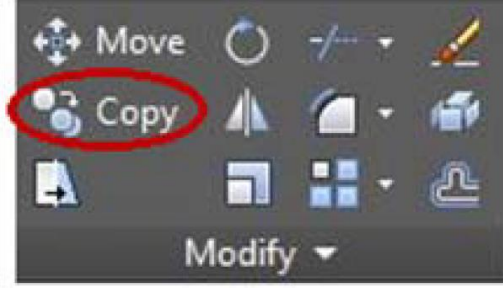

Yarıçapı 50 olan çember çizilir ve seçilir.

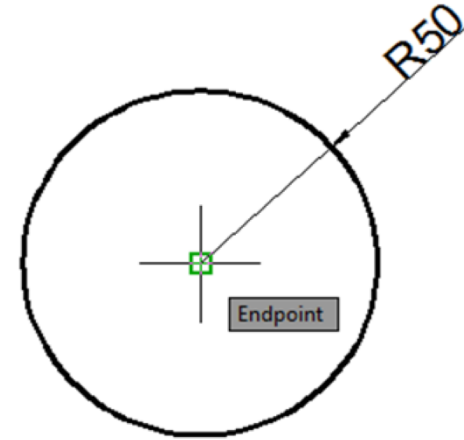

Çizim üzerinde taşıma noktası seçilir.

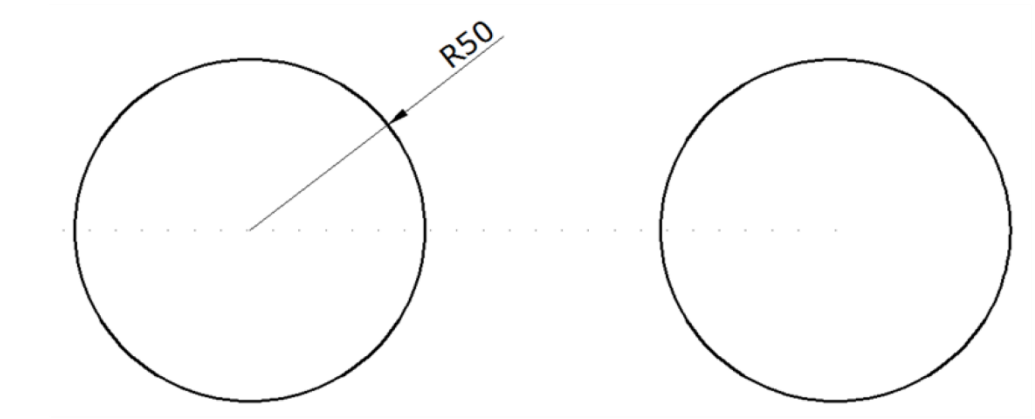
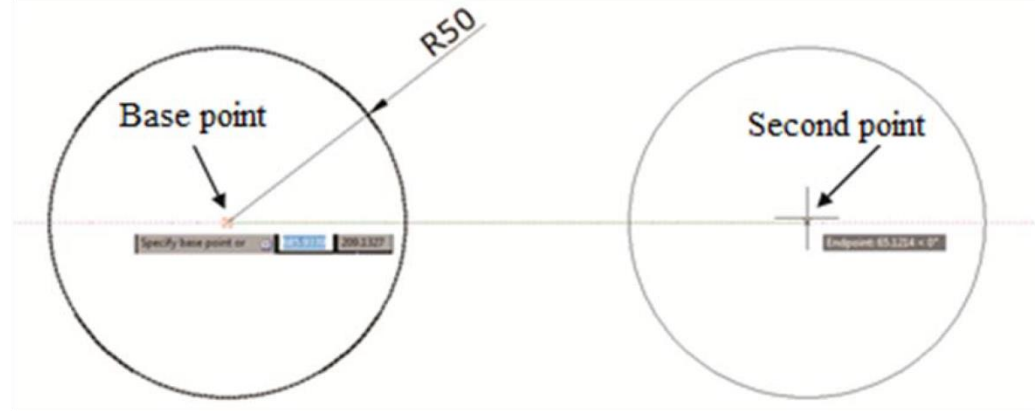

İşlemler sonucu elde edilen görüntü

Offset (O) Nesnenin Paralelini Oluřturma

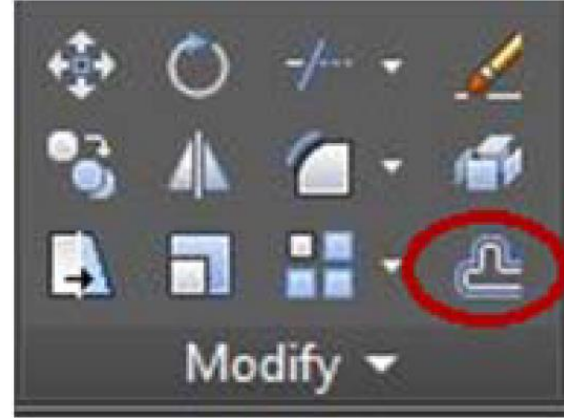

Select object to offset or [Exit/Undo] <Exit>: (E)

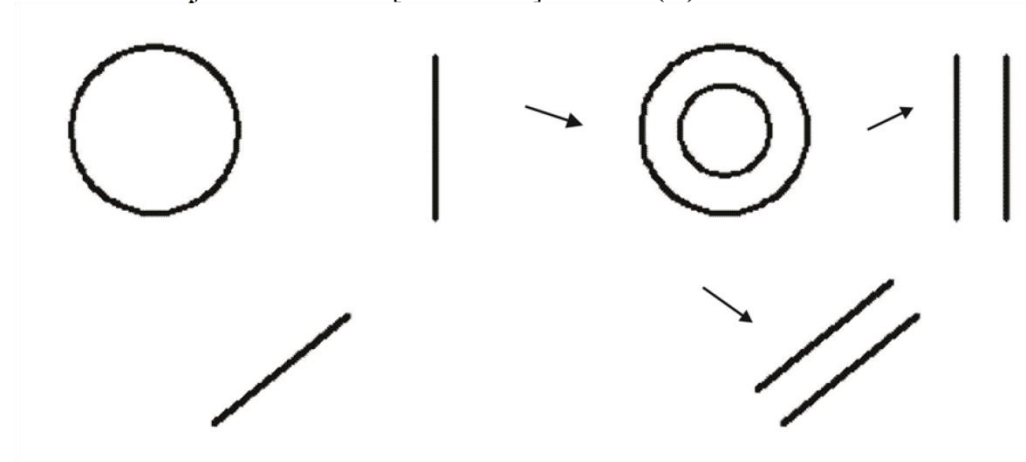

Önce

Sonra

Scale (Sc) Ölçeklendirme (Büyütme/Küçültme)

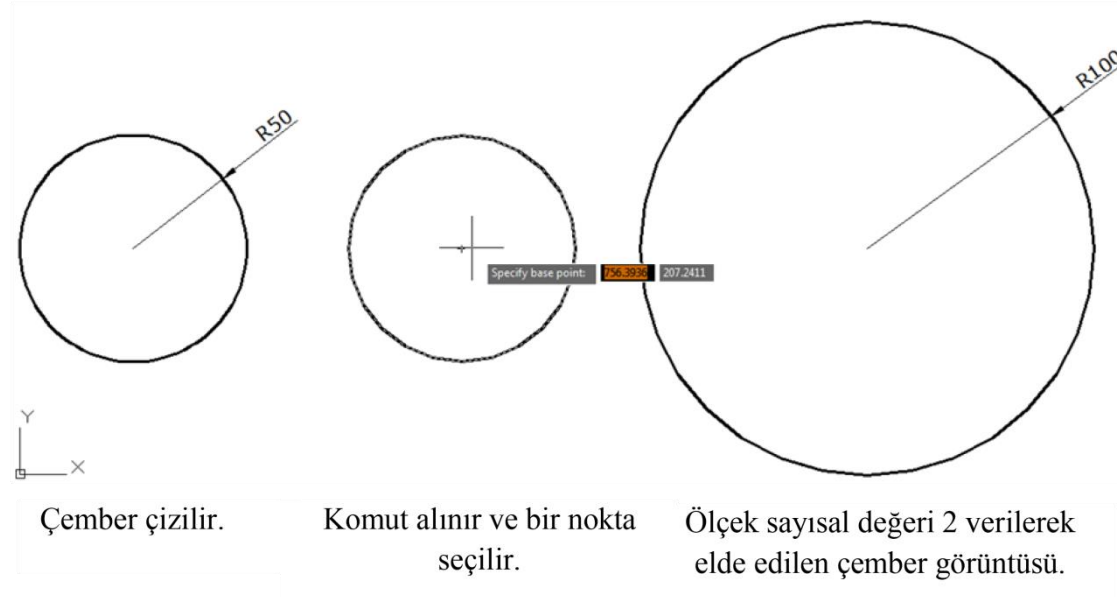
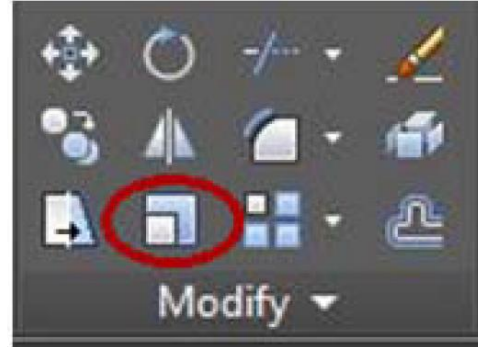

Mirror (Mi) Aynalama (Simetrik Alma)

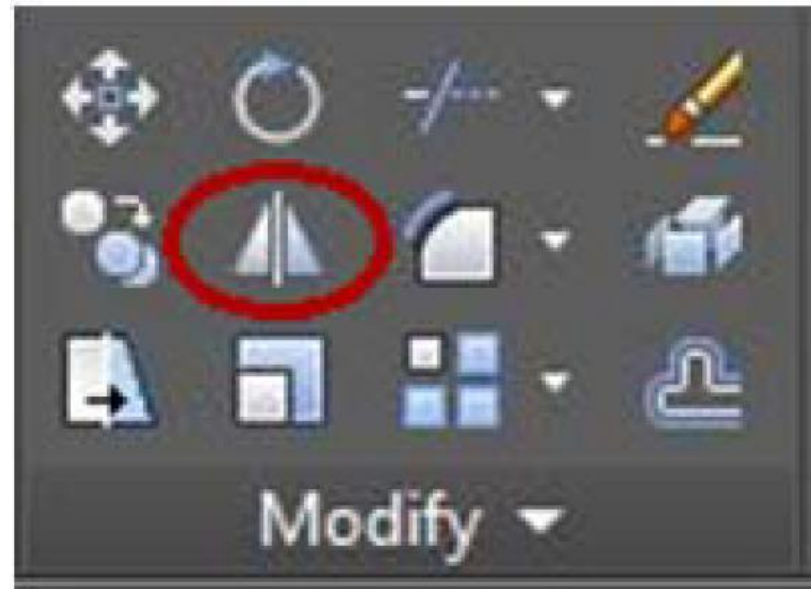

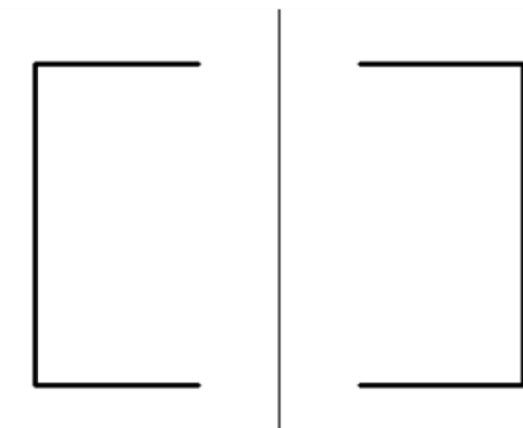
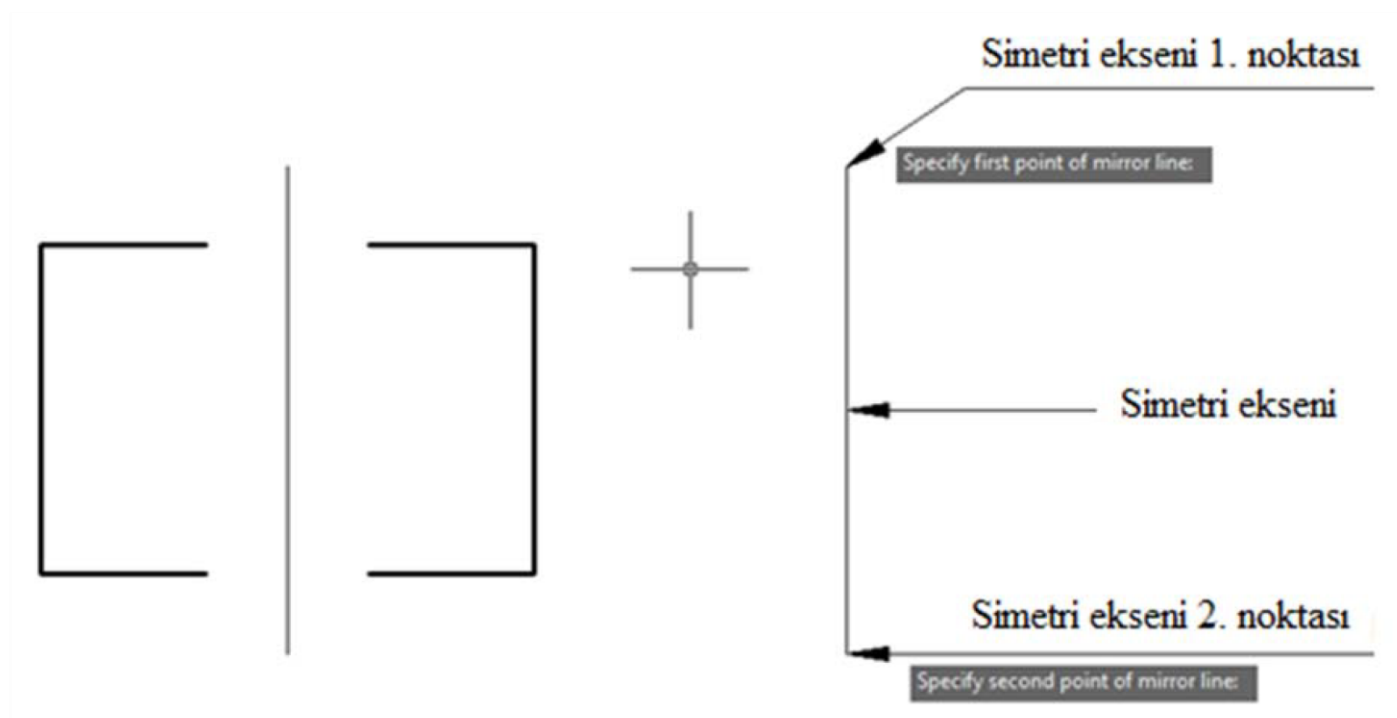

Rotate (Ro) Döndürme

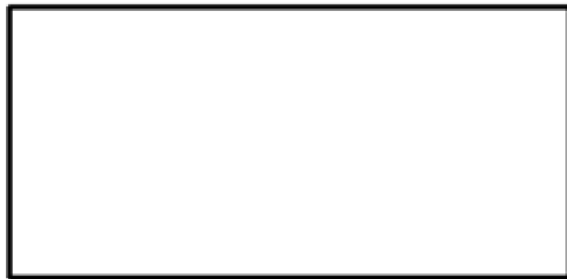

önce

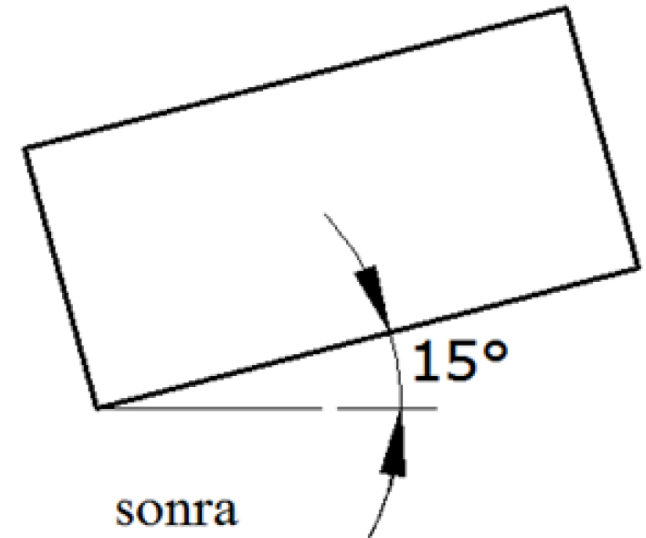

sonra

Array (Ar) Dizi Olarak Kopyalama (ođaltma)

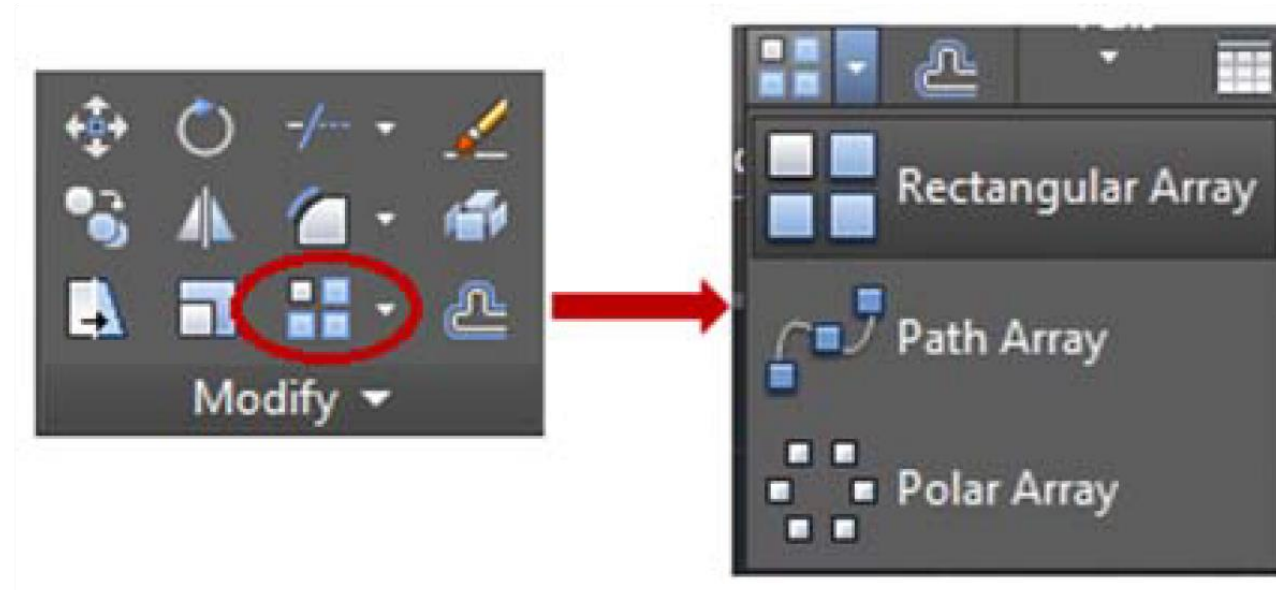

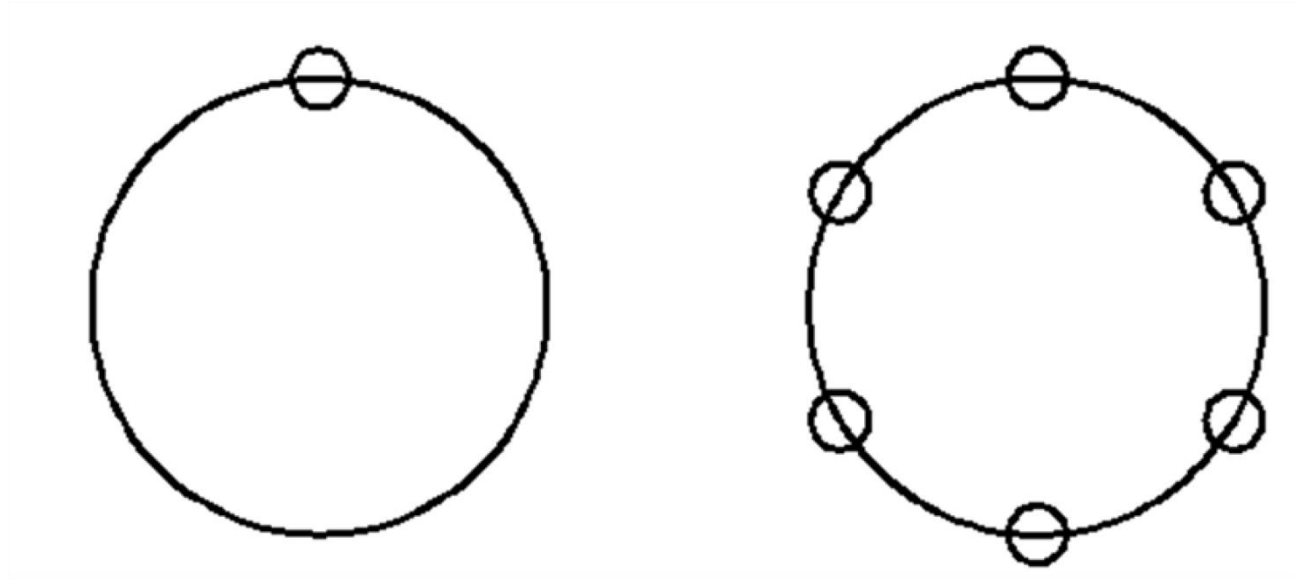
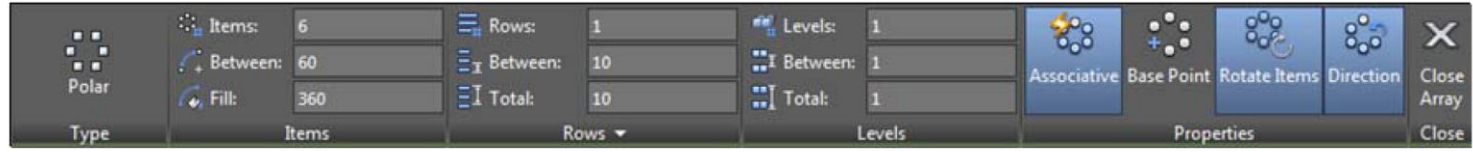

Önce

Sonra

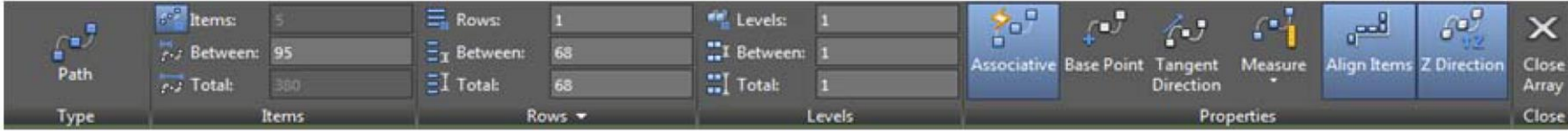

Aşağıdaki örnekte istenilen objeden beş adet çoğaltma yapılmıştır.

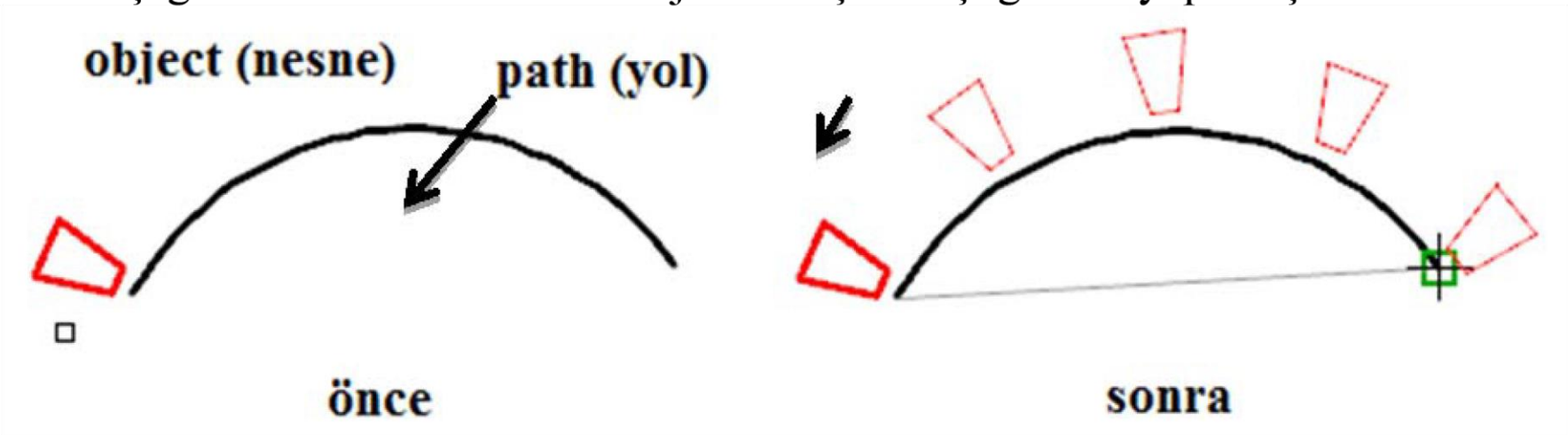

Trim/Extend Budama / Uzatma

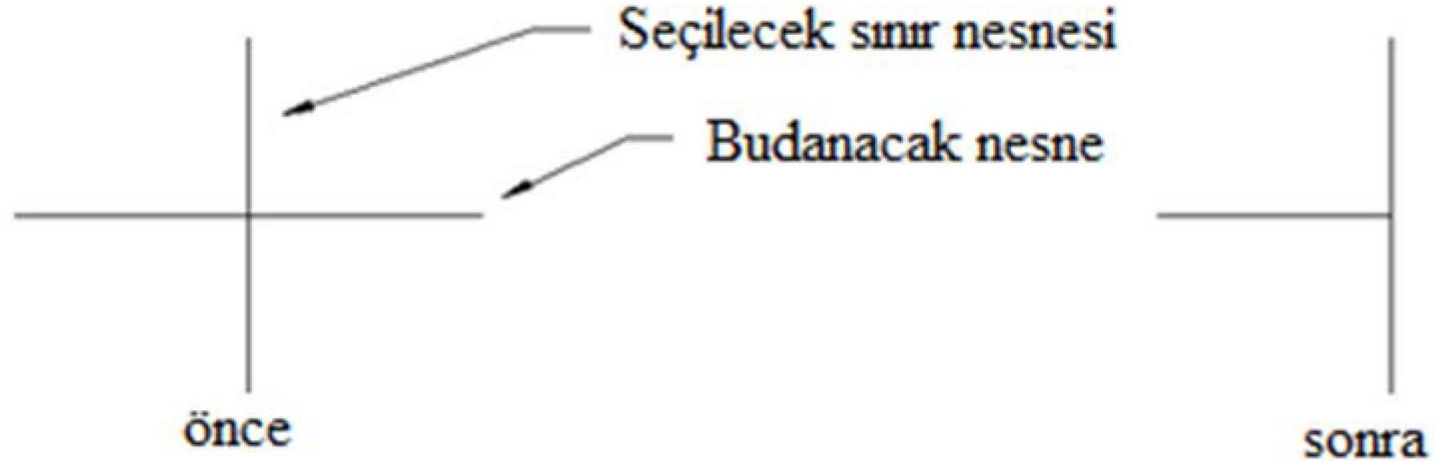

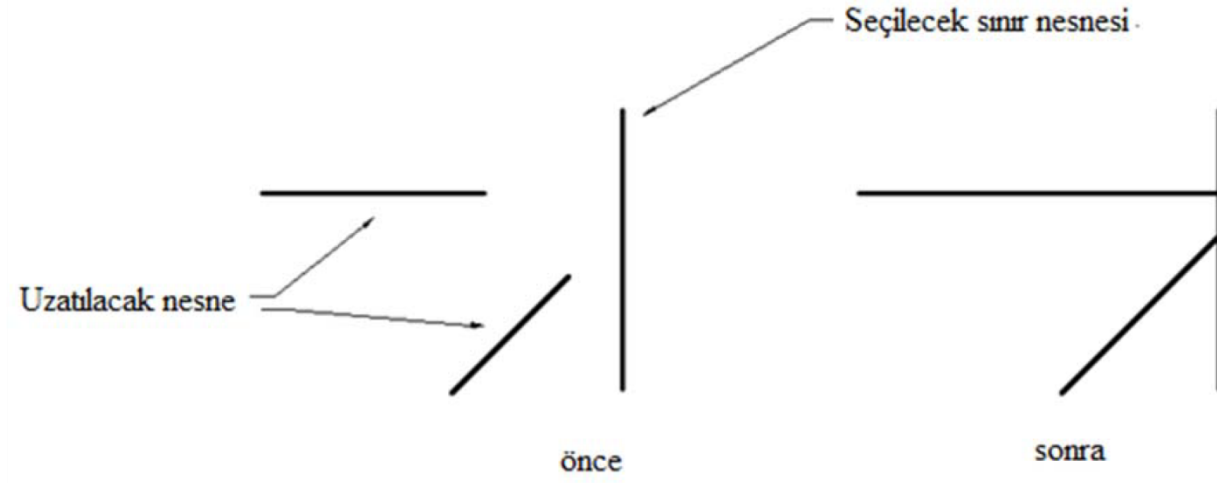
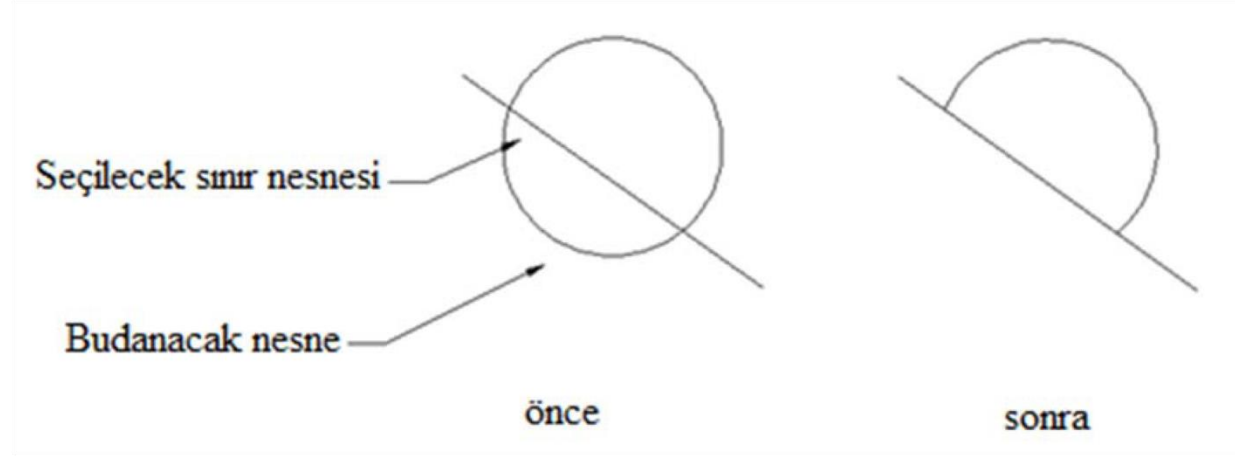

Fillet/ Chamfer/ Blend Curves Yuvarlatma/ Pah kırma/ Eğrileri Kaynaştırma

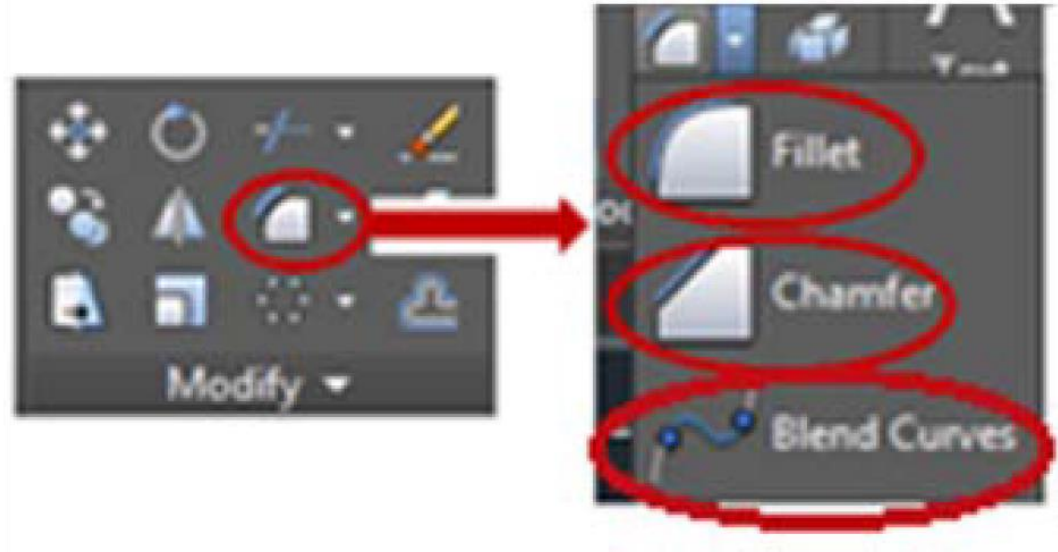

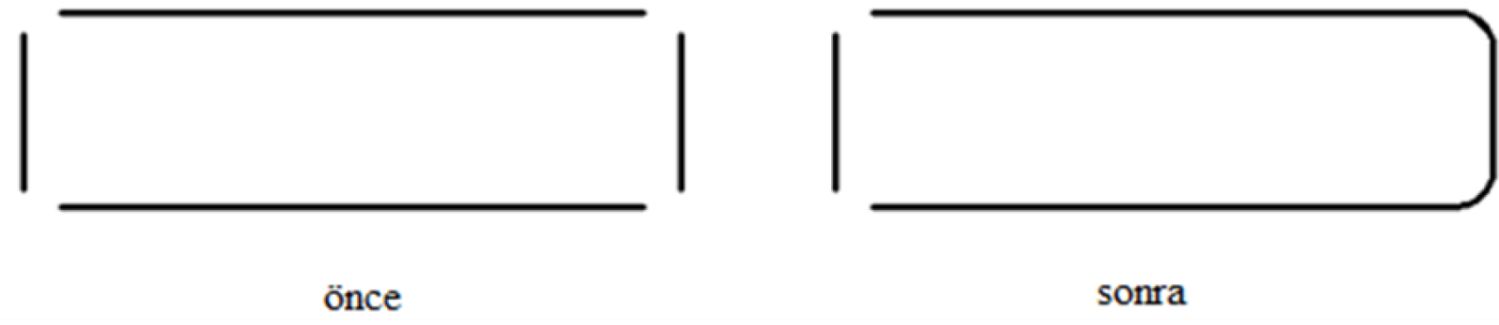
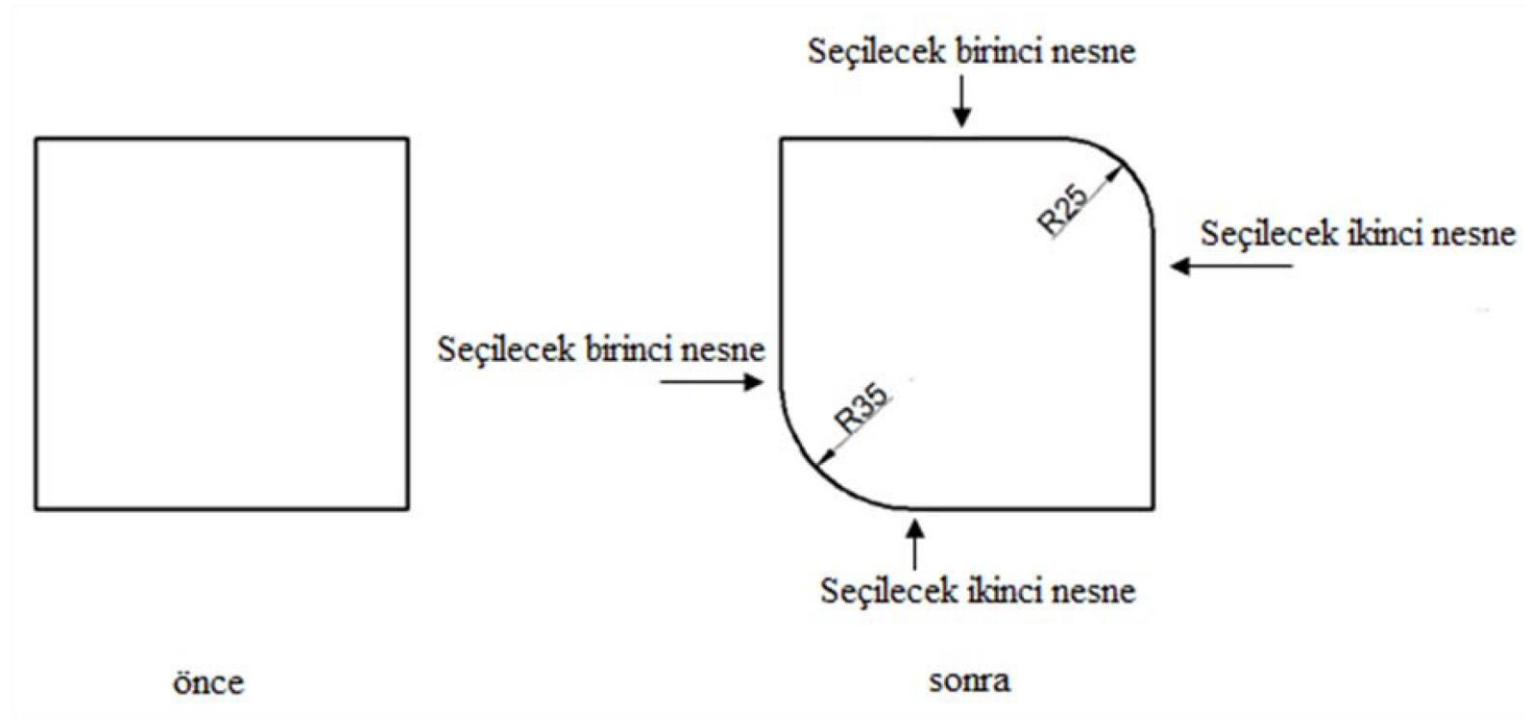

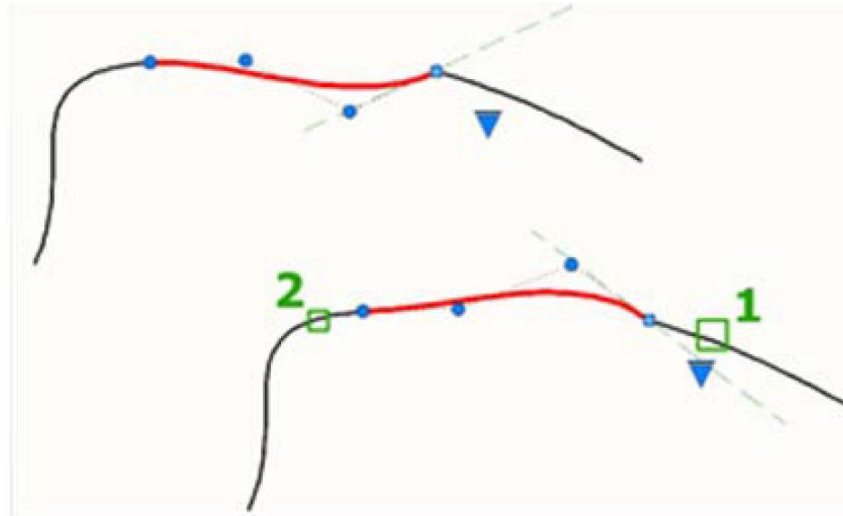
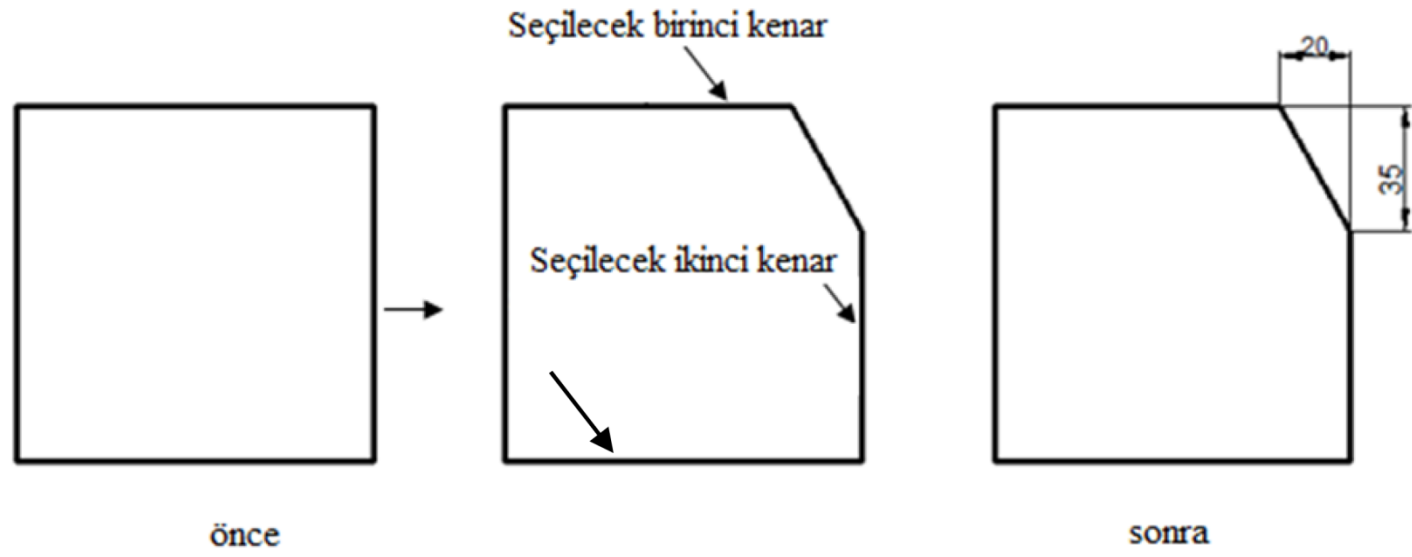

Stretch Uzatma/Kısaltma

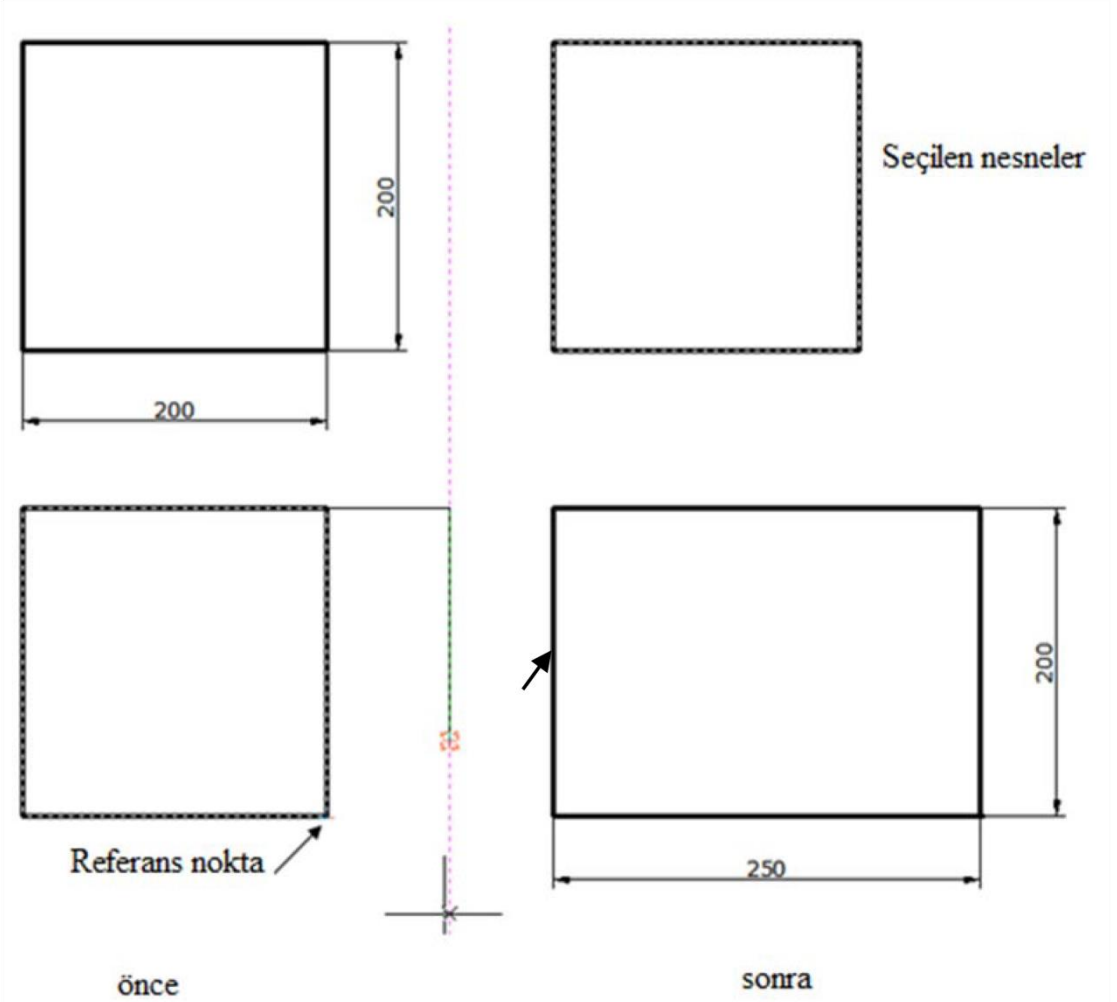
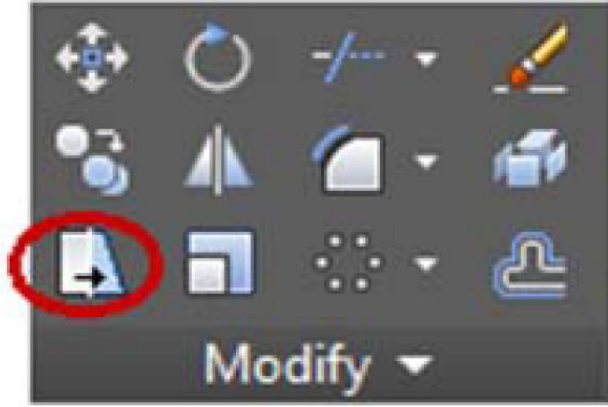

Explode Patlatma

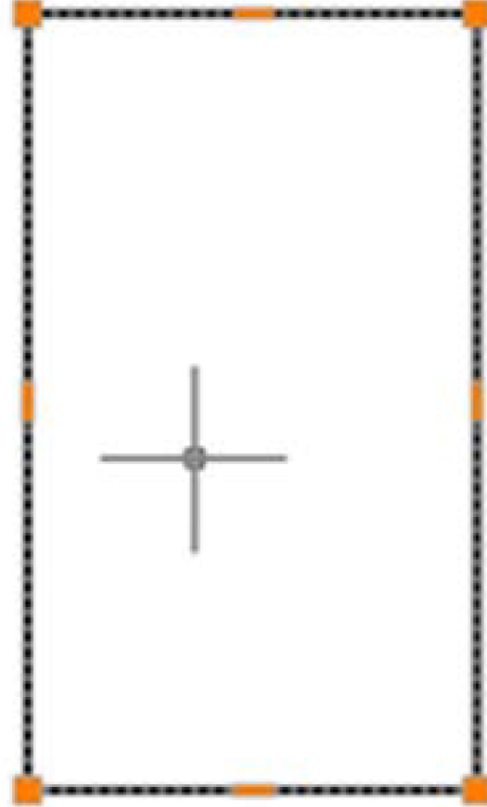
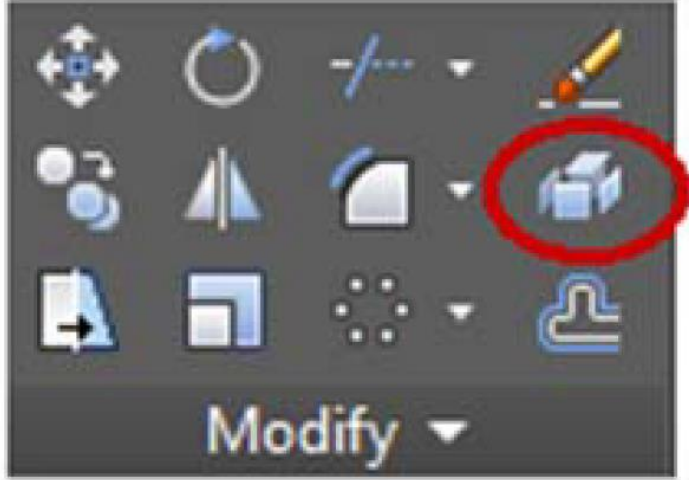

önce

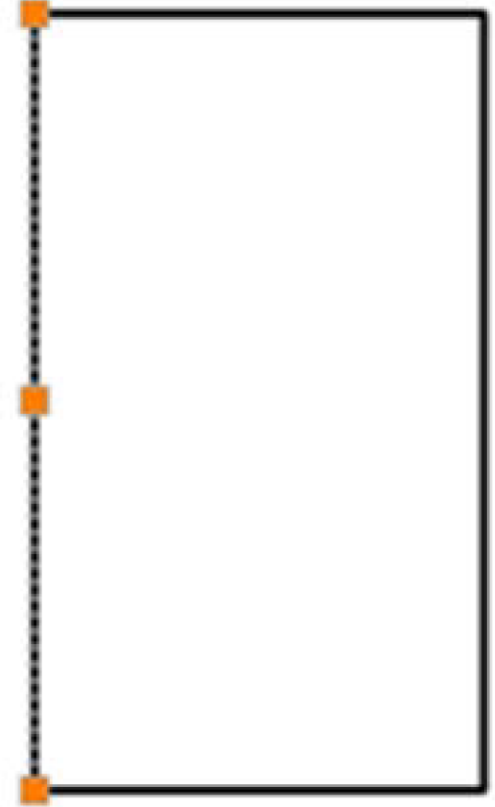

sonra