

KATILARIN ELEKTRONİK YAPISININ BENZETİŐİMİ

Kristal Fiziđi: Temel Kavramlar-2

Doç.Dr. YeŐim Mođulkoç

E-posta: mogulkoc@eng.ankara.edu.tr

Tel: 0312 2033550

Miller Indices

Miller Indices are a symbolic vector representation for the orientation of an atomic plane in a crystal lattice and are defined as the reciprocals of the fractional intercepts which the plane makes with the crystallographic axes.

To determine Miller indices of a plane, take the following steps;

- 1) Determine the intercepts of the plane along each of the three crystallographic directions
- 2) Take the reciprocals of the intercepts
- 3) If fractions result, multiply each by the denominator of the smallest fraction

Example-1

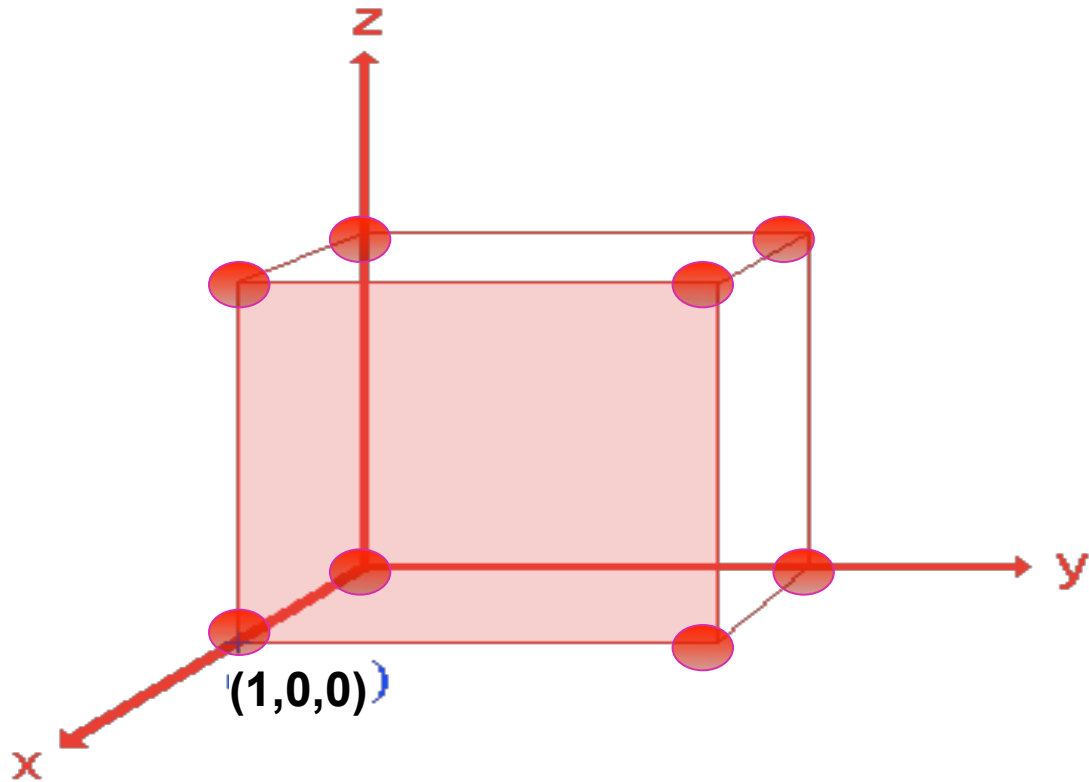

Axis	X	Y	Z
Intercept points	1	∞	∞
Reciprocals	1/1	1/ ∞	1/ ∞
Smallest Ratio	1	0	0
Miller Indices (100)			

Example-2

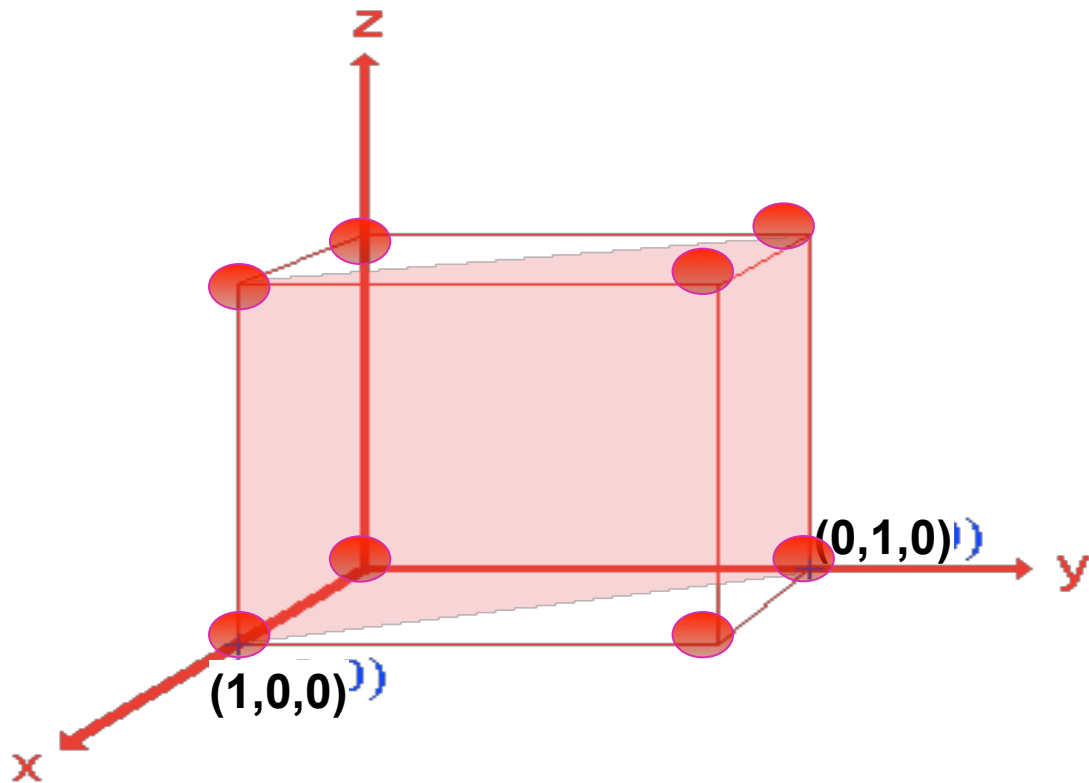

Axis	X	Y	Z
Intercept points	1	1	∞
Reciprocals	1/1	1/1	1/ ∞
Smallest Ratio	1	1	0
Miller Indices (110)			

Example-3

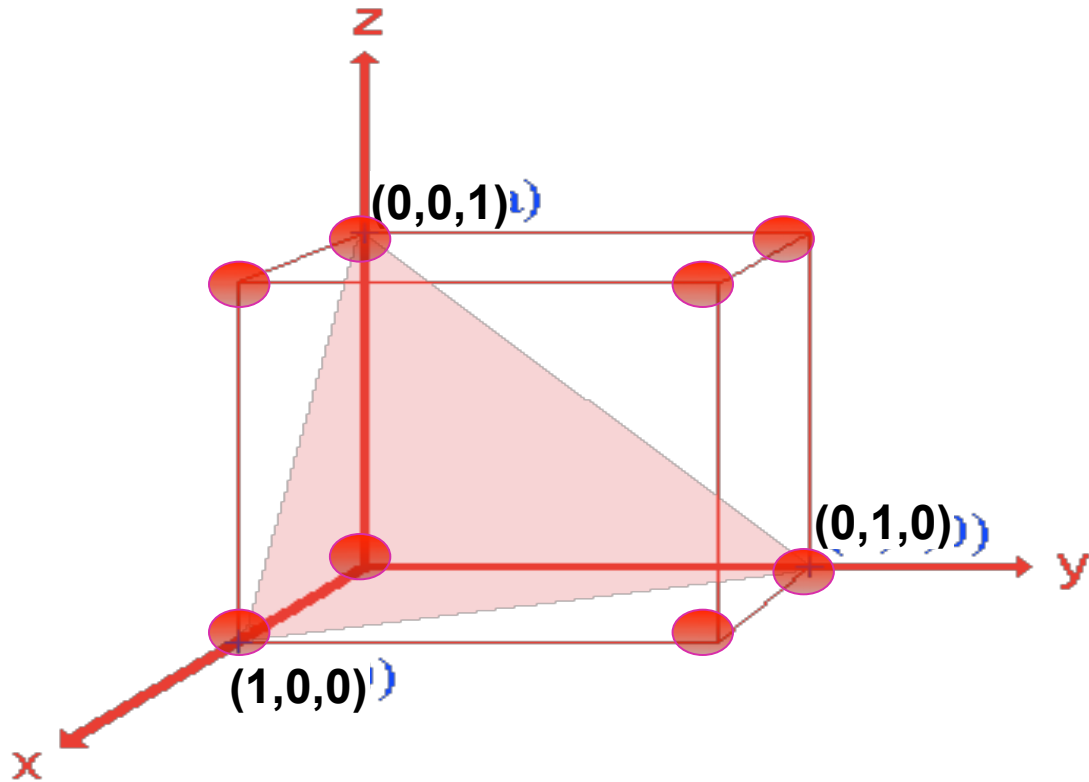

Axis	X	Y	Z
Intercept points	1	1	1
Reciprocals	1/1	1/1	1/1
Smallest Ratio	1	1	1
Miller Indices (111)			

Example-4

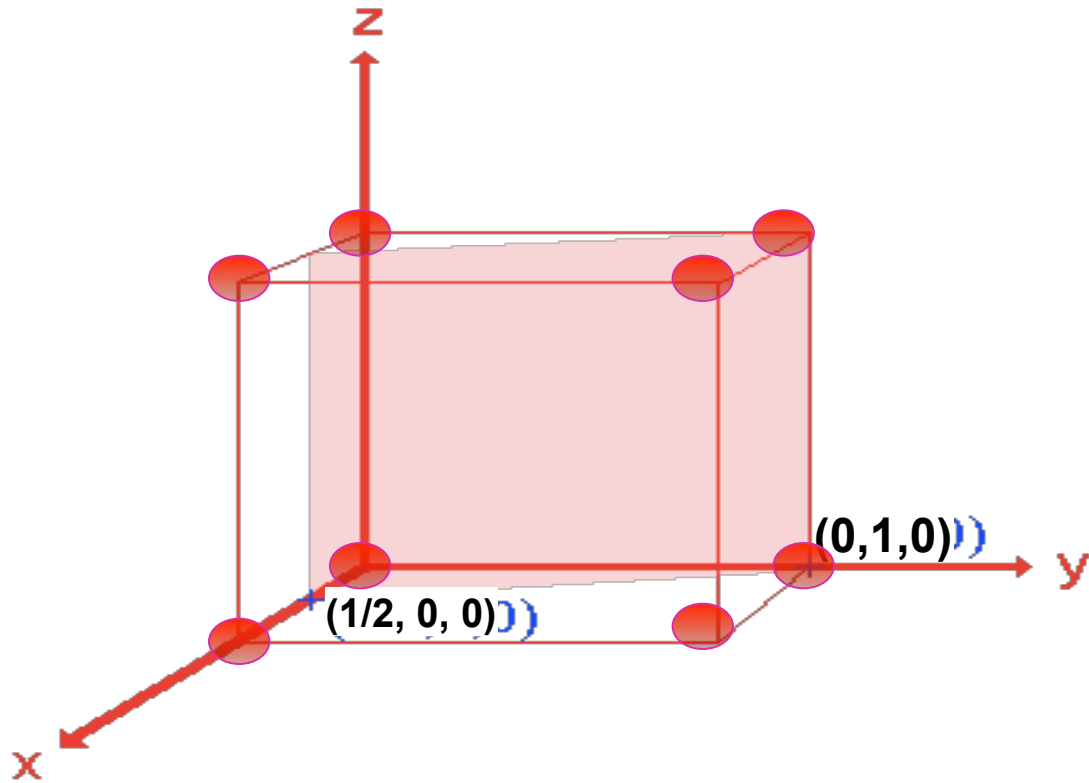

Axis	X	Y	Z
Intercept points	$1/2$	1	∞
Reciprocals	$1/(1/2)$	$1/1$	$1/\infty$
Smallest Ratio	2	1	0
Miller Indices		(210)	

Example-5

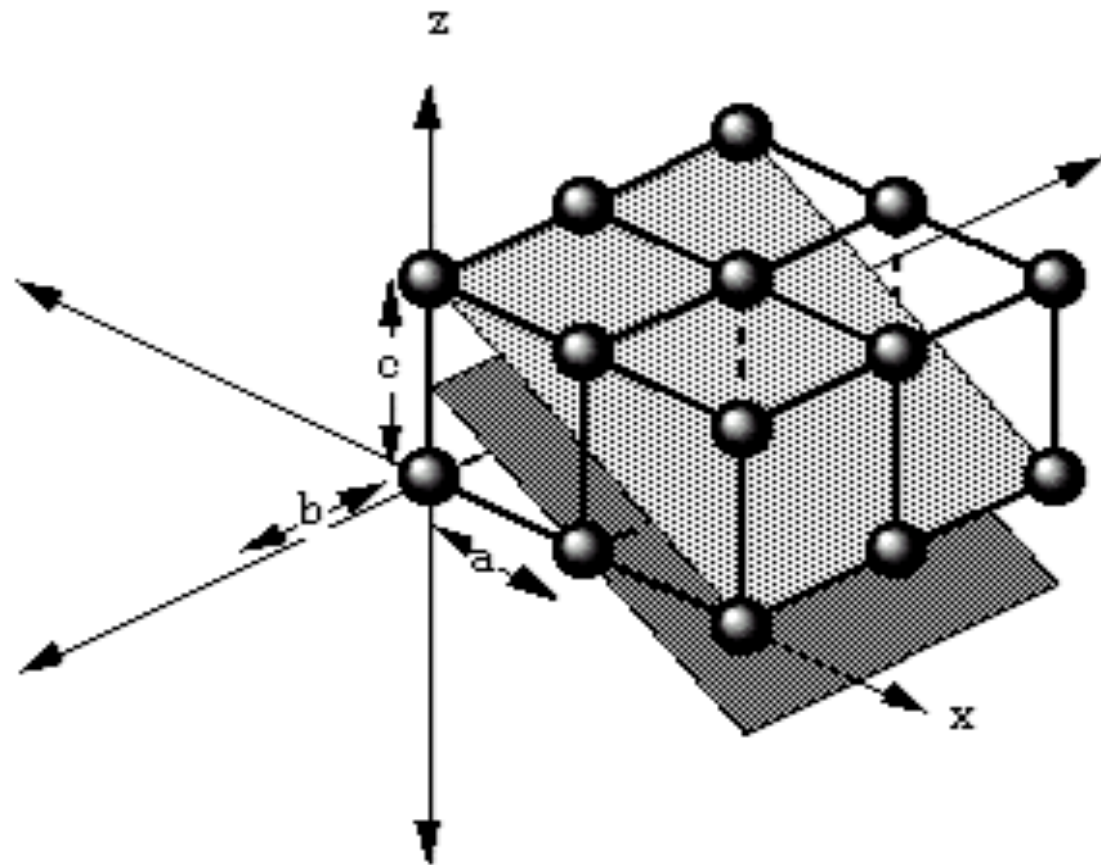

Axis	a	b	c
Intercept points	1	∞	$1/2$
Reciprocals	1/1	$1/\infty$	$1/(1/2)$
Smallest Ratio	1	0	2
Miller Indices (102)			

Example-6

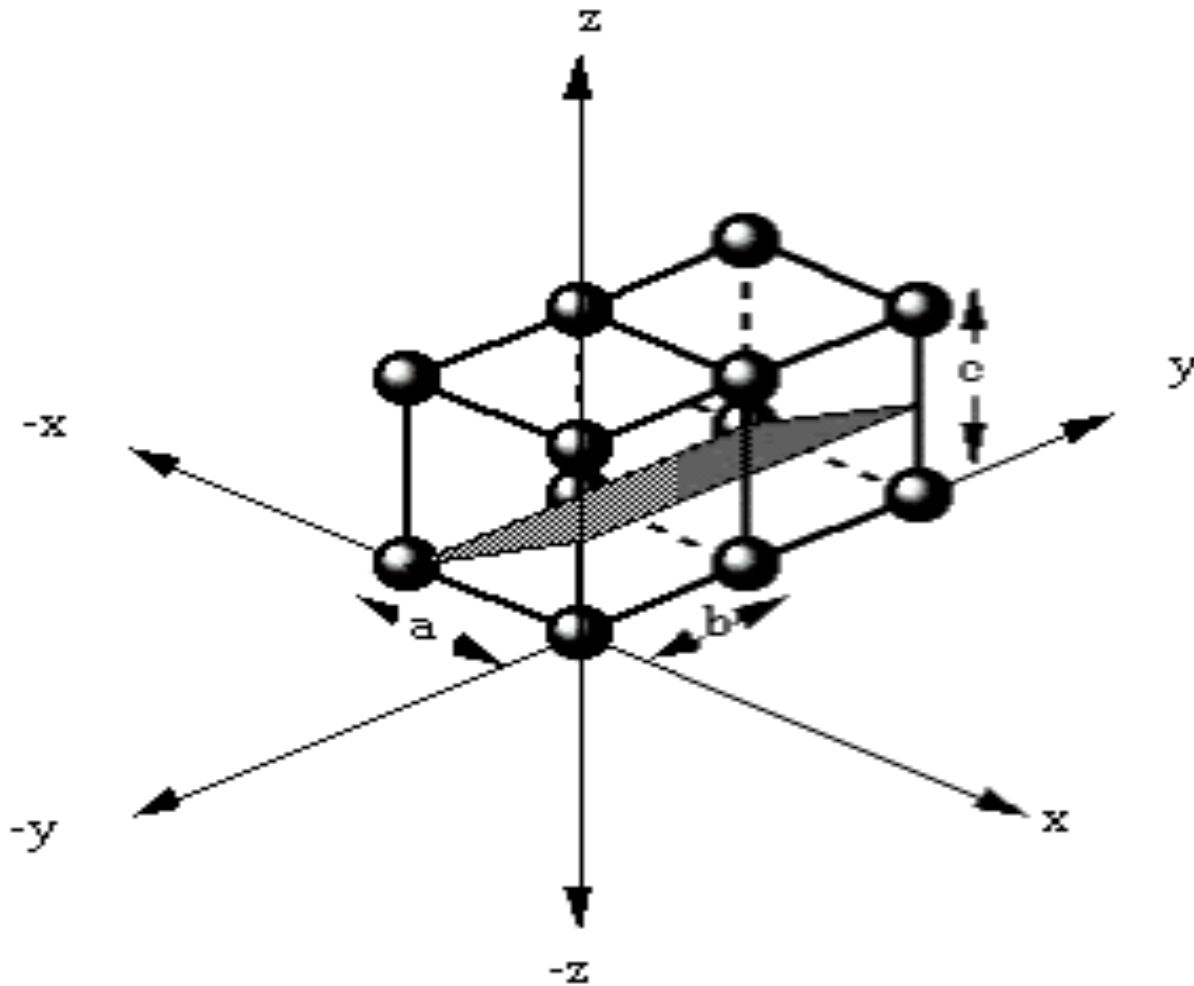

Axis	a	b	c
Intercept points	-1	∞	$1/2$
Reciprocals	1/-1	1/ ∞	1/($1/2$)
Smallest Ratio	-1	0	2
Miller indices	$(\bar{1}02)$		

Miller Indices

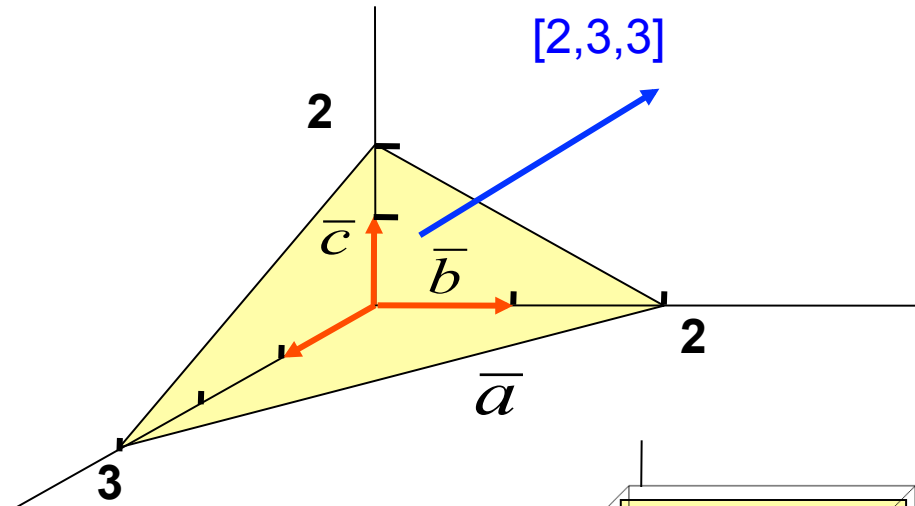

Plane intercepts axes at

$$3\bar{a}, 2\bar{b}, 2\bar{c}$$

Reciprocal numbers are:

$$\frac{1}{3}, \frac{1}{2}, \frac{1}{2}$$

Indices of the plane (Miller): **(2,3,3)**

Indices of the direction: **[2,3,3]**

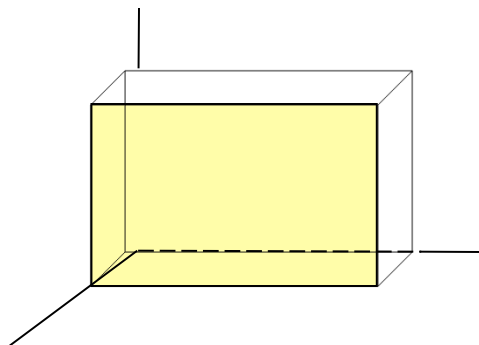

(100)

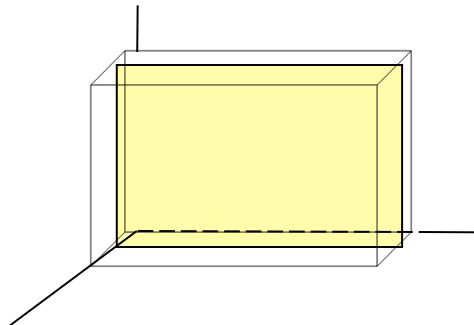

(200)

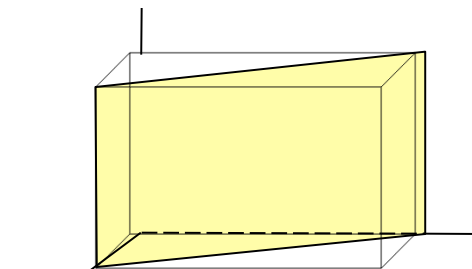

(110)

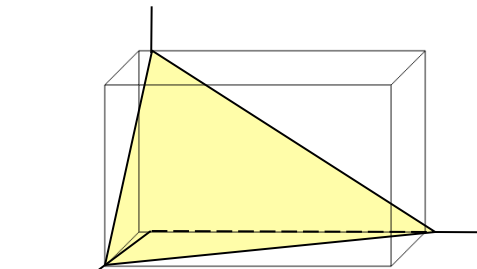

(111)

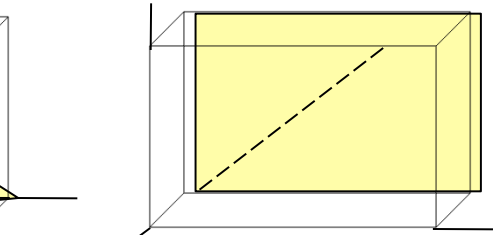

(100)

TYPICAL CRYSTAL STRUCTURES

3D – 14 BRAVAIS LATTICES AND THE SEVEN CRYSTAL SYSTEM

- There are only seven different shapes of unit cell which can be stacked together to completely fill all space (in 3 dimensions) without overlapping. This gives the seven crystal systems, in which all crystal structures can be classified.
- Cubic Crystal System (SC, BCC, FCC)
- Hexagonal Crystal System (S)
- Triclinic Crystal System (S)
- Monoclinic Crystal System (S, Base-C)
- Orthorhombic Crystal System (S, Base-C, BC, FC)
- Tetragonal Crystal System (S, BC)
- Trigonal (Rhombohedral) Crystal System (S)

CUBIC

$$a = b = c$$
$$\alpha = \beta = \gamma = 90^\circ$$

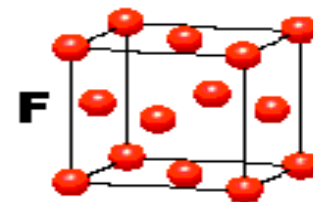
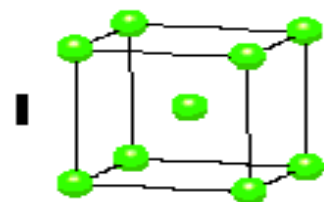
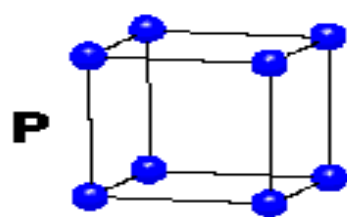

TETRAGONAL

$$a = b \neq c$$
$$\alpha = \beta = \gamma = 90^\circ$$

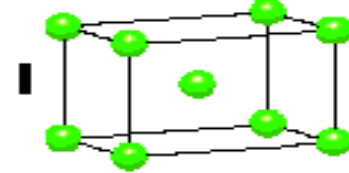
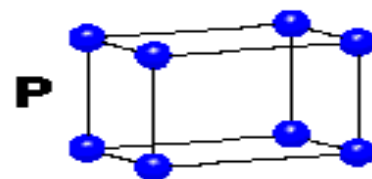

ORTHORHOMBIC

$$a \neq b \neq c$$
$$\alpha = \beta = \gamma = 90^\circ$$

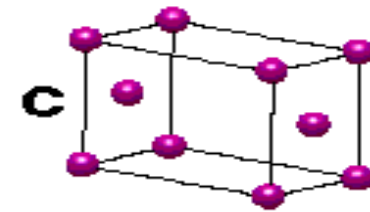
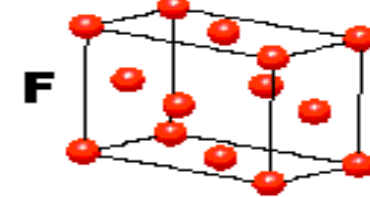
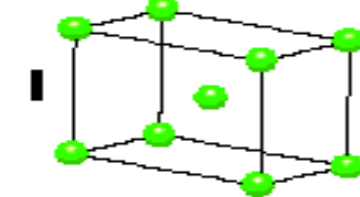
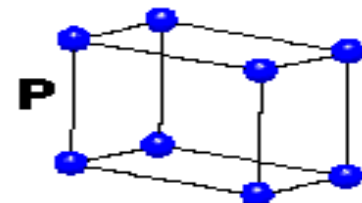

HEXAGONAL

$$a = b \neq c$$
$$\alpha = \beta = 90^\circ$$
$$\gamma = 120^\circ$$

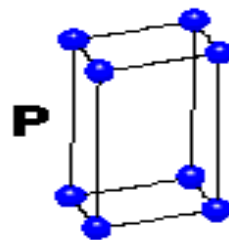

TRIGONAL

$$a = b = c$$
$$\alpha = \beta = \gamma \neq 90^\circ$$

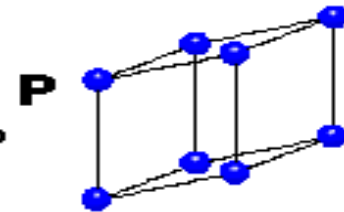

MONOCLINIC

$$a \neq b \neq c$$
$$\alpha = \gamma = 90^\circ$$
$$\beta \neq 120^\circ$$

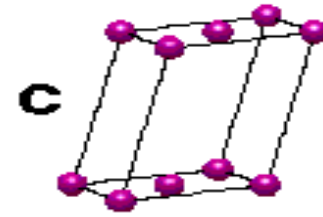
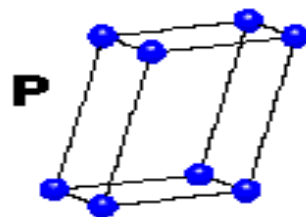

TRICLINIC

$$a \neq b \neq c$$
$$\alpha \neq \beta \neq \gamma \neq 90^\circ$$

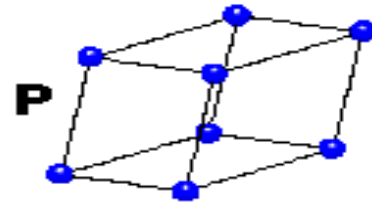

4 Types of Unit Cell

P = Primitive

I = Body-Centred

F = Face-Centred

C = Side-Centred

+

7 Crystal Classes

→ **14 Bravais Lattices**

1-CUBIC CRYSTAL SYSTEM

a- Simple Cubic (SC)

- Simple Cubic has one lattice point so its primitive cell.
- In the unit cell on the left, the atoms at the corners are cut because only a portion (in this case 1/8) belongs to that cell. The rest of the atom belongs to neighboring cells.
- Coordination number of simple cubic is 6

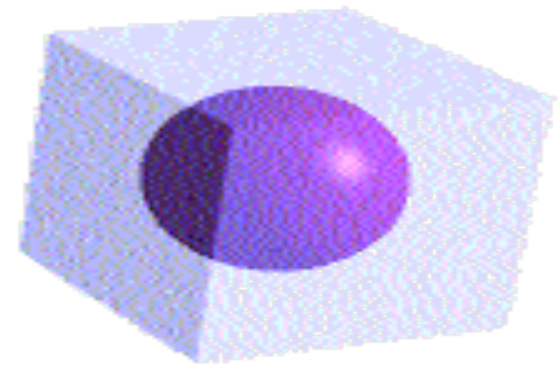
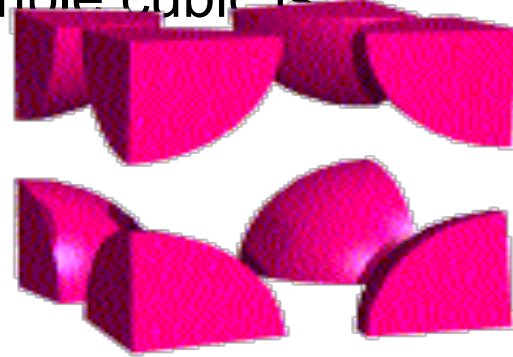
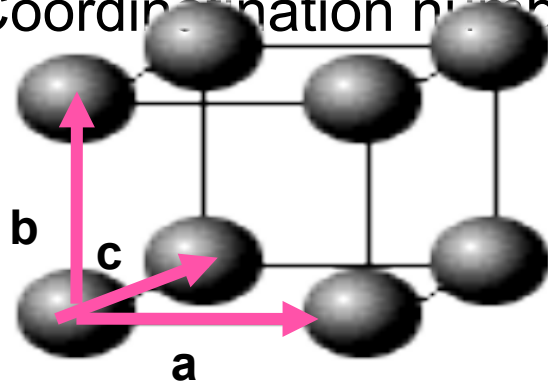

Atomic Packing Factor of SC

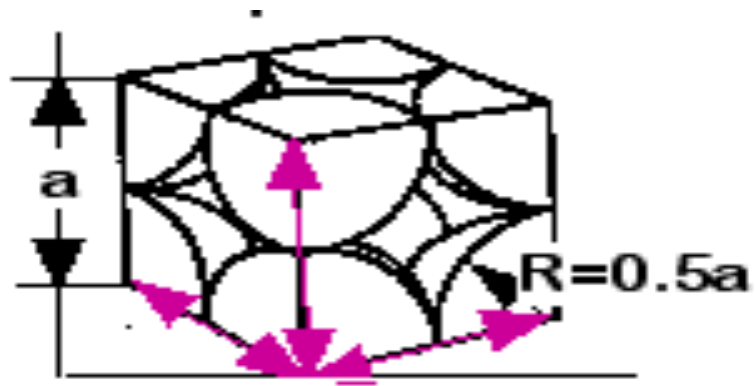

contains $8 \times 1/8 =$
1 atom/unit cell

APF = 0.52 for simple cubic

$$\text{APF} = \frac{\text{atom/unit cell} \times \frac{4}{3} \pi (0.5a)^3}{a^3} = \frac{1 \times \frac{4}{3} \pi (0.5a)^3}{a^3}$$

The diagram shows the calculation of the Atomic Packing Factor (APF) for a simple cubic unit cell. The numerator represents the total volume of atoms in the unit cell, and the denominator represents the volume of the unit cell.

- atom/unit cell:** A green box highlights the number '1' in the numerator, with an arrow pointing to the text 'atom/unit cell'.
- volume/atom:** A brown box highlights the term $\frac{4}{3} \pi (0.5a)^3$ in the numerator, with an arrow pointing to the text 'volume/atom'.
- volume/unit cell:** A blue box highlights the term a^3 in the denominator, with an arrow pointing to the text 'volume/unit cell'.

b-Body Centered Cubic (BCC)

- BCC has two lattice points so BCC is a non-primitive cell.
- BCC has eight nearest neighbors. Each atom is in contact with its neighbors only along the body-diagonal directions.
- Many metals (Fe, Li, Na..etc), including the alkalis and several transition elements choose the BCC structure.

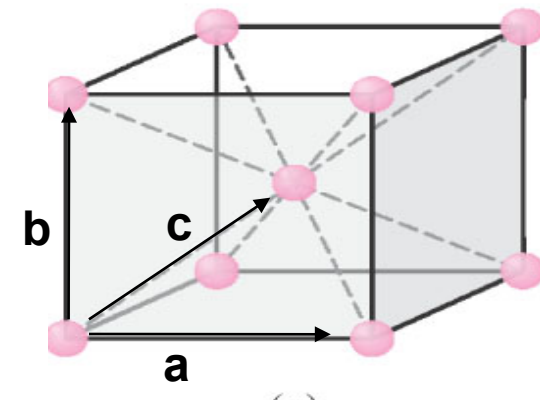
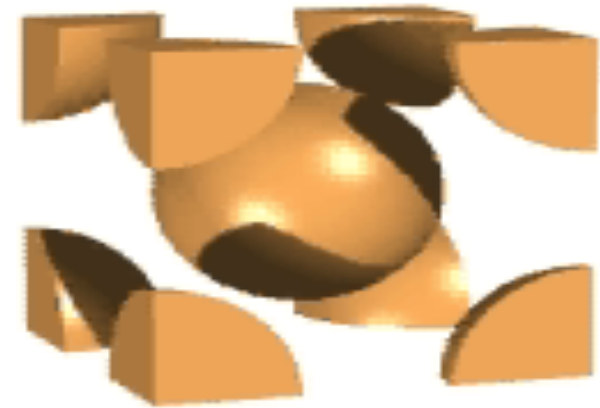

Atomic Packing Factor of BCC

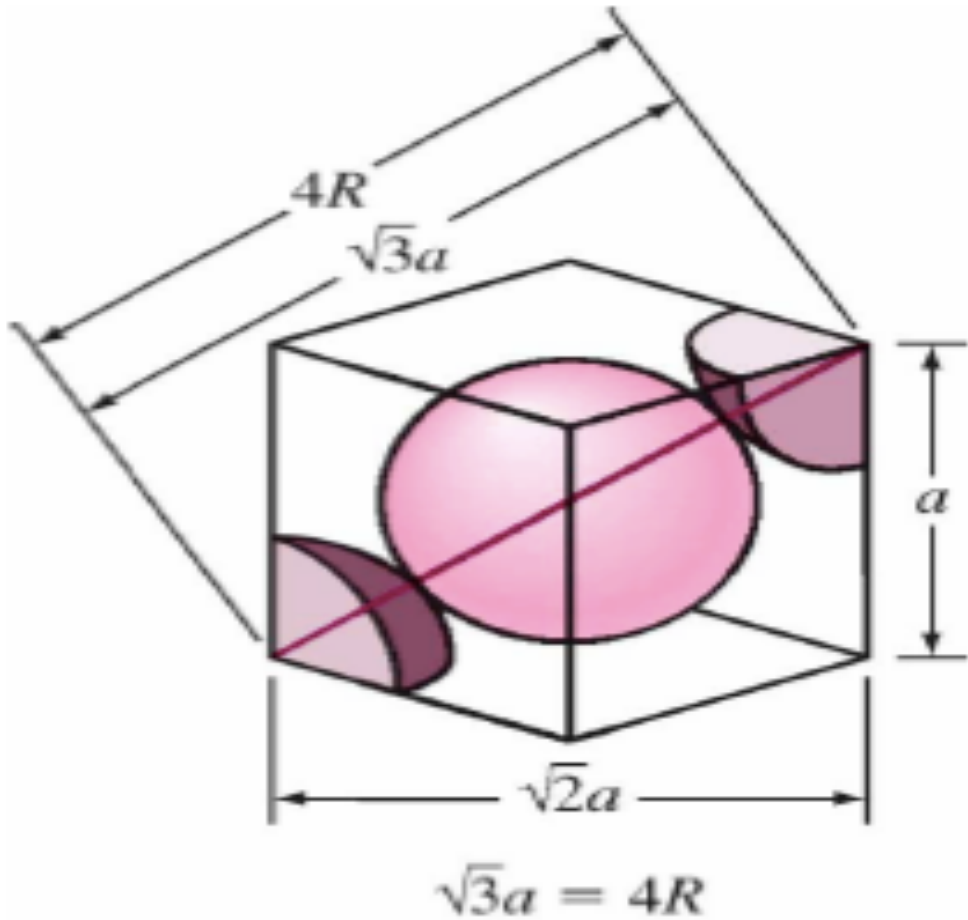

$$APF_{BCC} = \frac{V_{atoms}}{V_{unit\ cell}} = 0.68$$

$$APF = \frac{\text{atom unit cell} \left(2 \left| \frac{4}{3} (0,433a)a \right|^3 \right)}{\text{volume unit cell} \left(a^3 \right)}$$

Diagram illustrating the calculation of the Atomic Packing Factor (APF) for a BCC unit cell. The APF is defined as the ratio of the volume of atoms in the unit cell to the volume of the unit cell. The volume of atoms is calculated as $2 \left(\frac{4}{3} (0,433a)a \right)^3$, where 2 is the number of atoms per unit cell, $\frac{4}{3}$ is the volume of a sphere, and $(0,433a)a$ is the radius of the atom. The volume of the unit cell is a^3 .

c- Face Centered Cubic (FCC)

- There are atoms at the corners of the unit cell and at the center of each face.
- Face centered cubic has 4 atoms so its non primitive cell.
- Many of common metals (Cu,Ni,Pb..etc) crystallize in FCC structure.

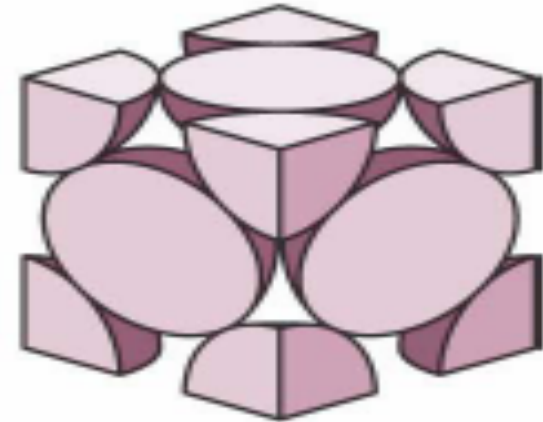
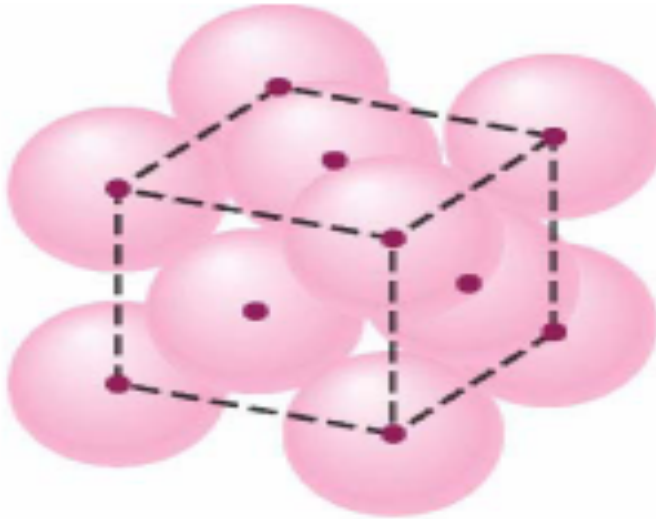
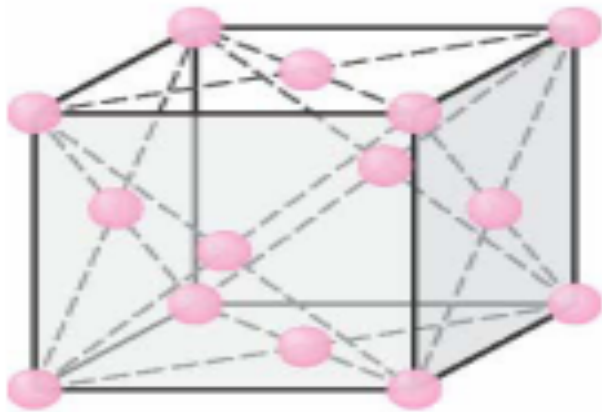

Atomic Packing Factor of FCC

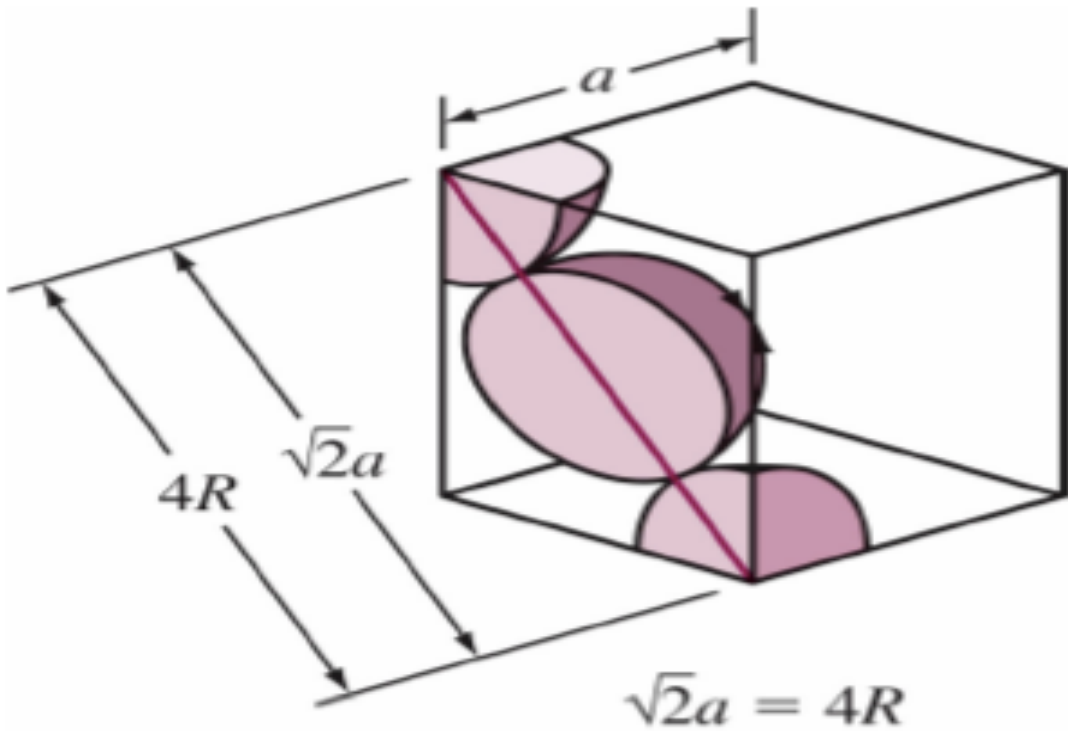

$$APF_{\text{FCC}} = \frac{V_{\text{atoms}}}{V_{\text{unit cell}}} = 0,743$$

$$APF = \frac{\text{atom unit cell} \cdot \frac{4}{3} \pi (0,353a)^3}{\text{volume unit cell} \cdot a^3} = \frac{\text{volume atom}}{\text{volume unit cell}}$$

2 - HEXAGONAL SYSTEM

- A crystal system in which three equal coplanar axes intersect at an angle of 60° , and a perpendicular to the others, is of a different length.

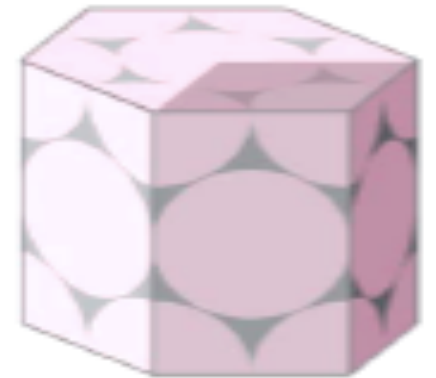
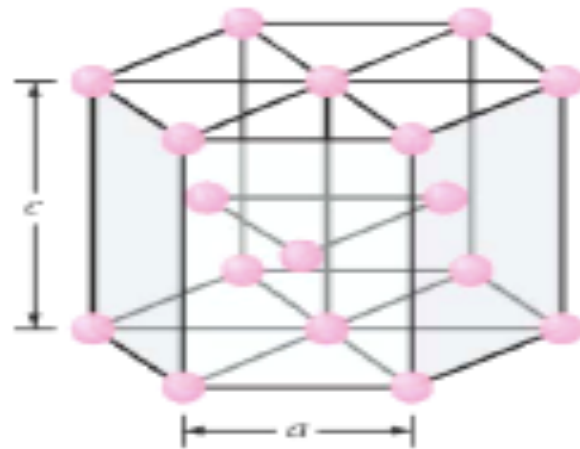
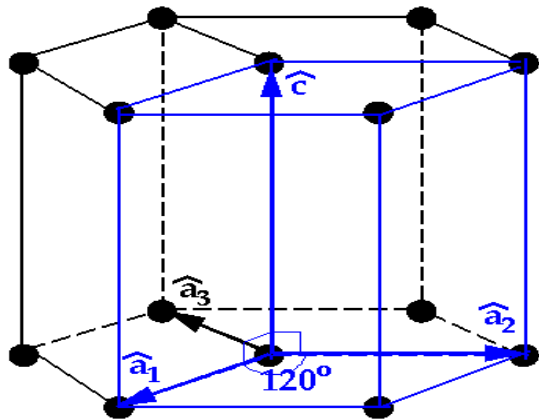

3 - TRICLINIC

4 - MONOCLINIC CRYSTAL SYSTEM

- Triclinic minerals are the least symmetrical. Their three axes are all different lengths and none of them are perpendicular to each other. These minerals are the most difficult to recognize.

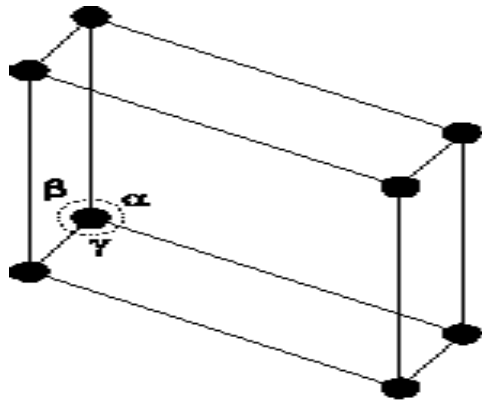

Triclinic (Simple)

$$\alpha \neq \beta \neq \gamma \neq 90^\circ$$

$$a \neq b \neq c$$

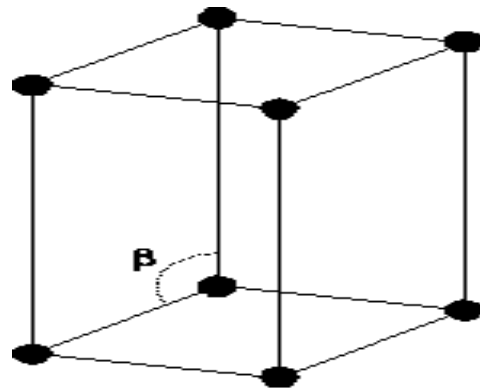

Monoclinic (Simple)

$$\alpha = \gamma = 90^\circ, \beta \neq 90^\circ$$

$$a \neq b \neq c$$

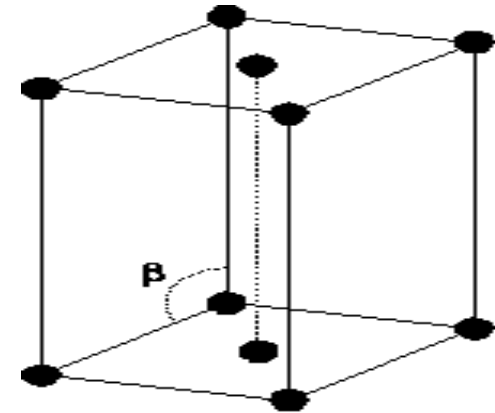

Monoclinic (Base Centered)

$$\alpha = \gamma = 90^\circ, \beta \neq 90^\circ$$

$$a \neq b \neq c,$$

5 - ORTHORHOMBIC SYSTEM

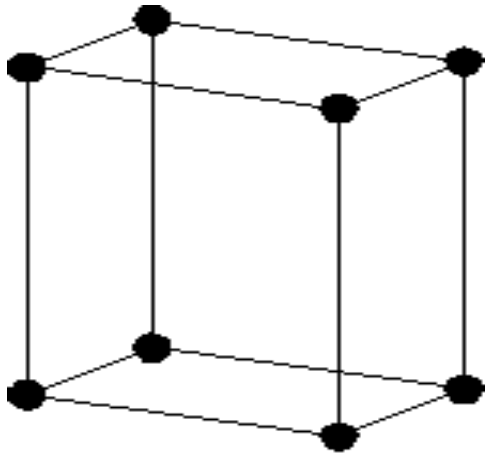

Orthorhombic (Simple)

$$\alpha = \beta = \gamma = 90^\circ$$

$$a \neq b \neq c$$

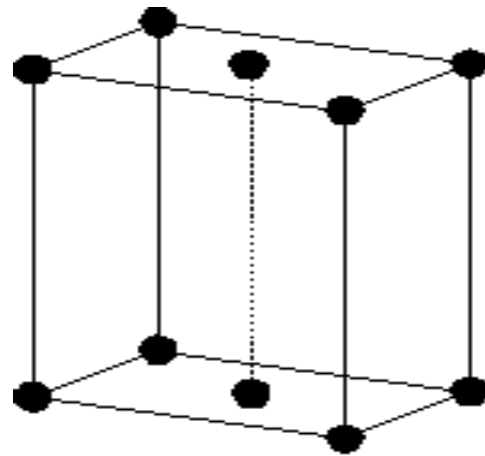

Orthorhombic (Base-centred)

$$\alpha = \beta = \gamma = 90^\circ$$

$$a \neq b \neq c$$

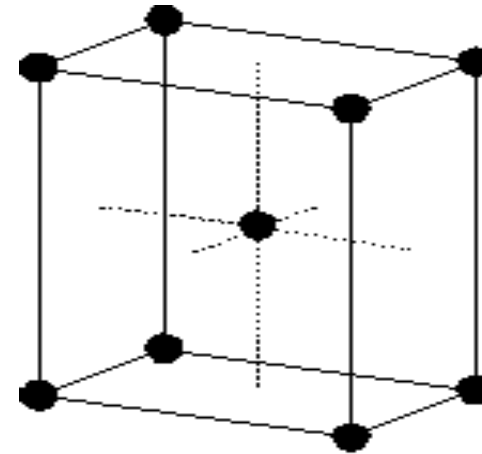

Orthorhombic (BC)

$$\alpha = \beta = \gamma = 90^\circ$$

$$a \neq b \neq c$$

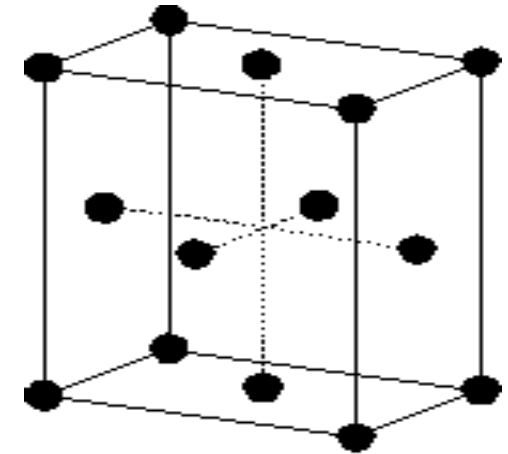

Orthorhombic (FC)

$$\alpha = \beta = \gamma = 90^\circ$$

$$a \neq b \neq c$$

6 – TETRAGONAL SYSTEM

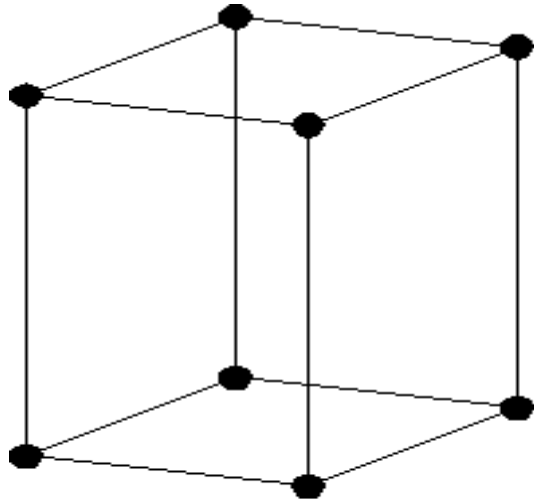

Tetragonal (P)
 $\alpha = \beta = \gamma = 90^\circ$
 $a = b \neq c$

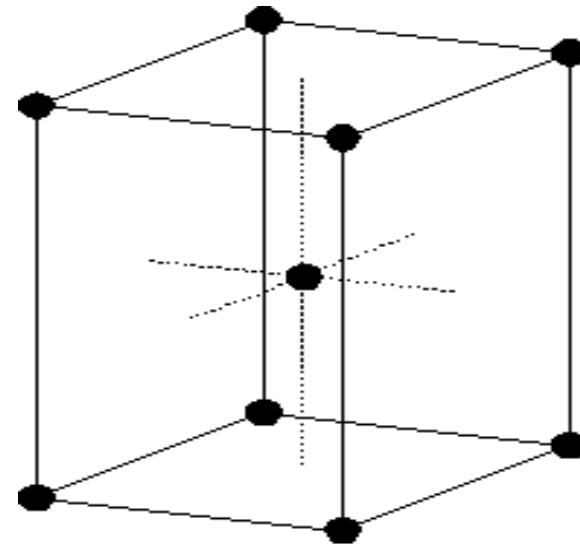

Tetragonal (BC)
 $\alpha = \beta = \gamma = 90^\circ$
 $a = b \neq c$

7 - Rhombohedral (R) or Trigonal

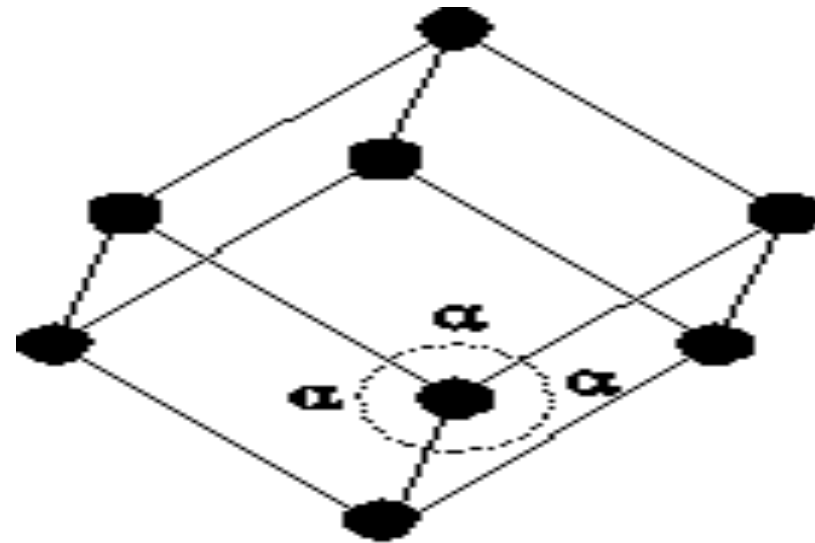

Rhombohedral (R) or Trigonal (S)

$$a = b = c, \alpha = \beta = \gamma \neq 90^\circ$$

THE MOST IMPORTANT CRYSTAL STRUCTURES

- Sodium Chloride Structure Na^+Cl^-
- Cesium Chloride Structure Cs^+Cl^-
- Hexagonal Closed-Packed Structure
- Diamond Structure
- Zinc Blende

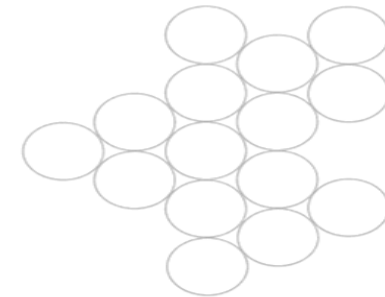

1 – Sodium Chloride Structure

- Sodium chloride also crystallizes in a cubic lattice, but with a different unit cell.
- Sodium chloride structure consists of equal numbers of sodium and chlorine ions placed at alternate points of a simple cubic lattice.
- Each ion has six of the other kind of ions as its nearest neighbours.

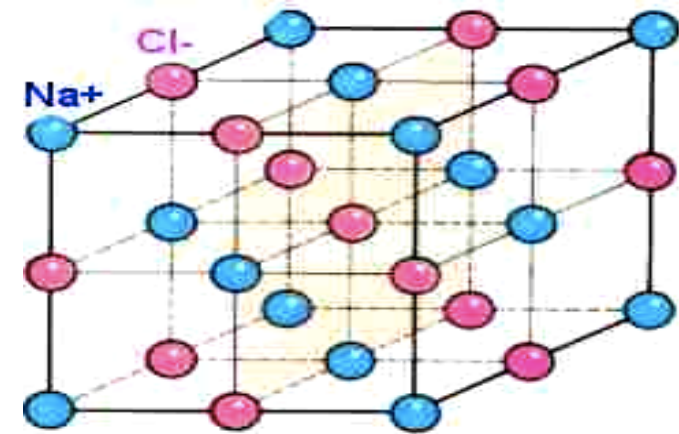
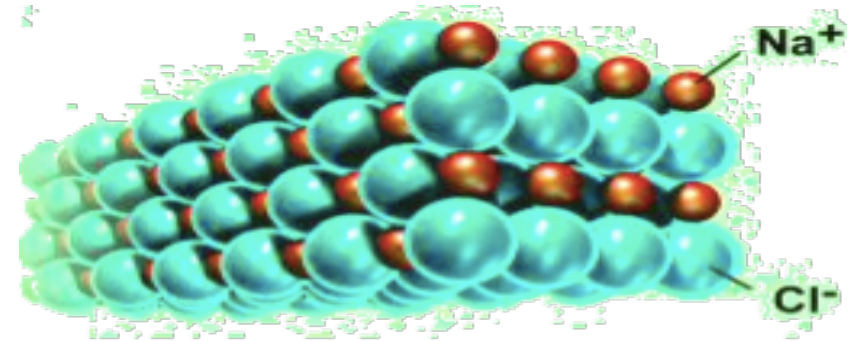

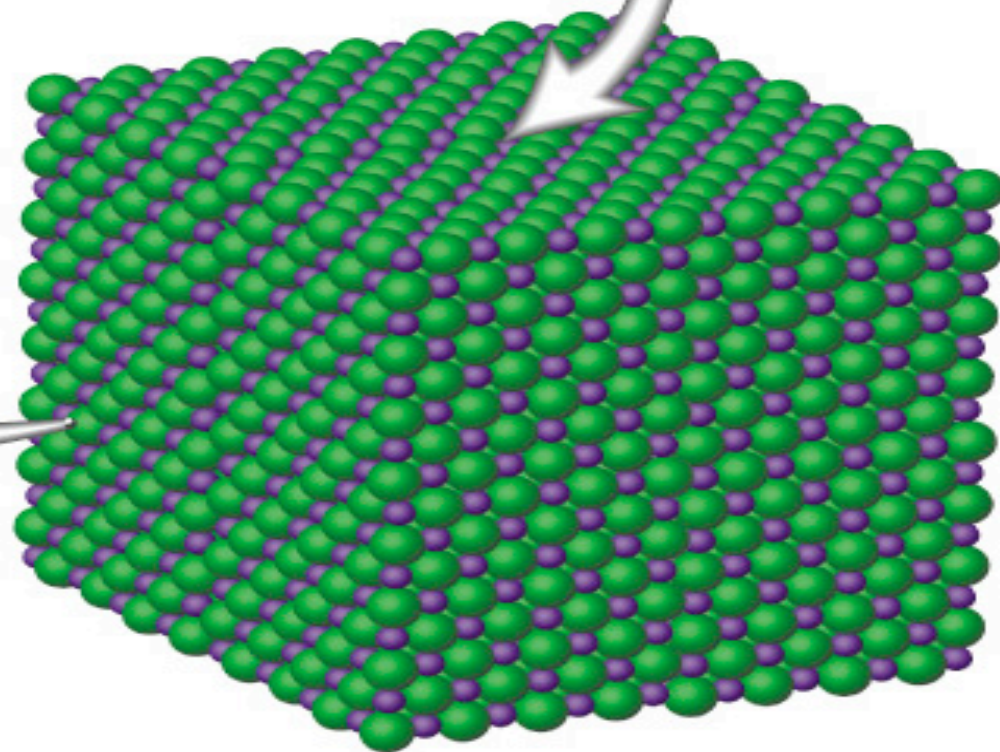
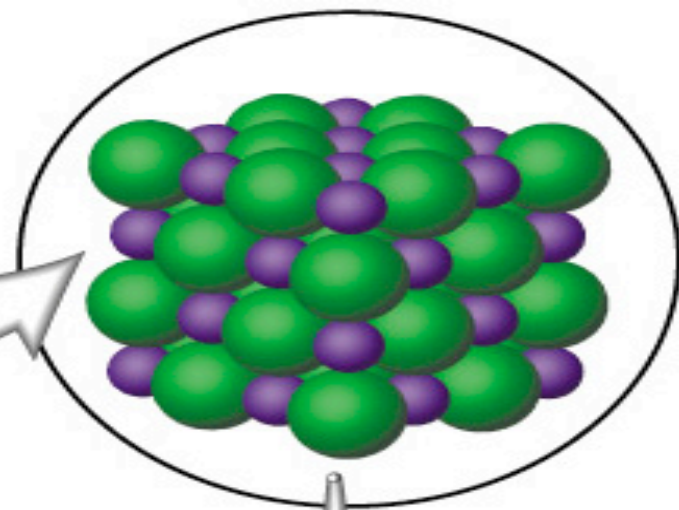
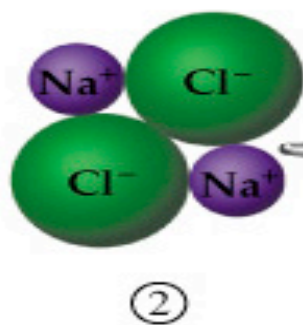
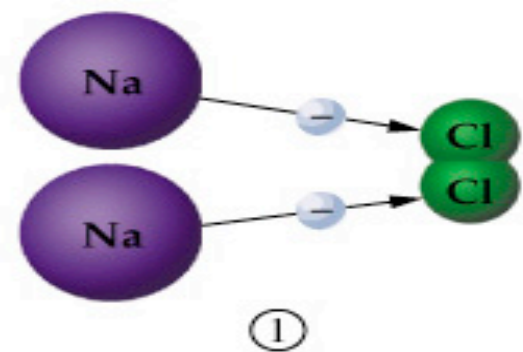

2-Cesium Chloride Structure Cs⁺Cl⁻

- Cesium chloride crystallizes in a cubic lattice. The unit cell may be depicted as shown. (Cs⁺ is teal, Cl⁻ is gold).
- *Cesium chloride consists of equal numbers of cesium and chlorine ions, placed at the points of a body-centered cubic lattice so that each ion has eight of the other kind as its nearest neighbors.*

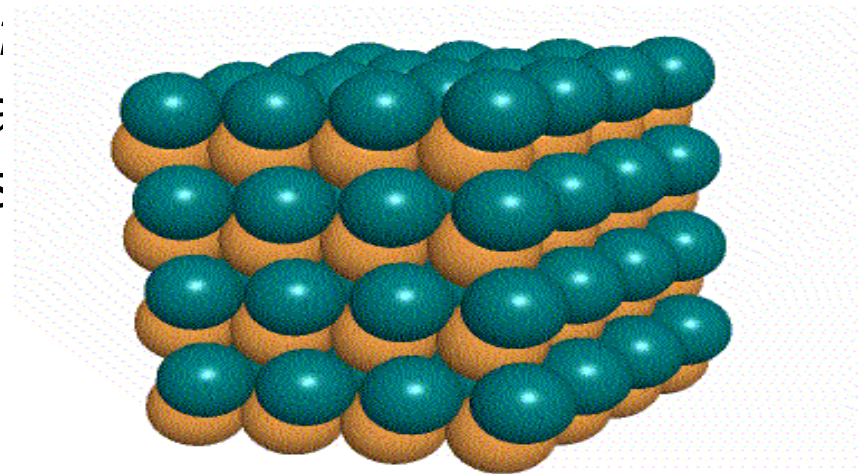
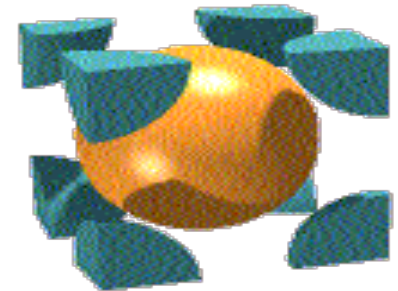

Cesium Chloride Cs^+Cl^-

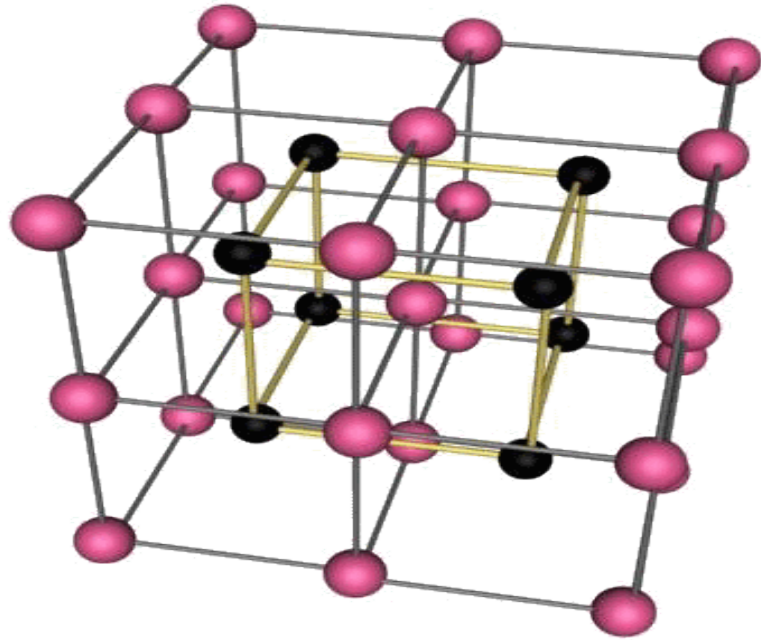
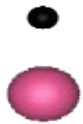

8 cell

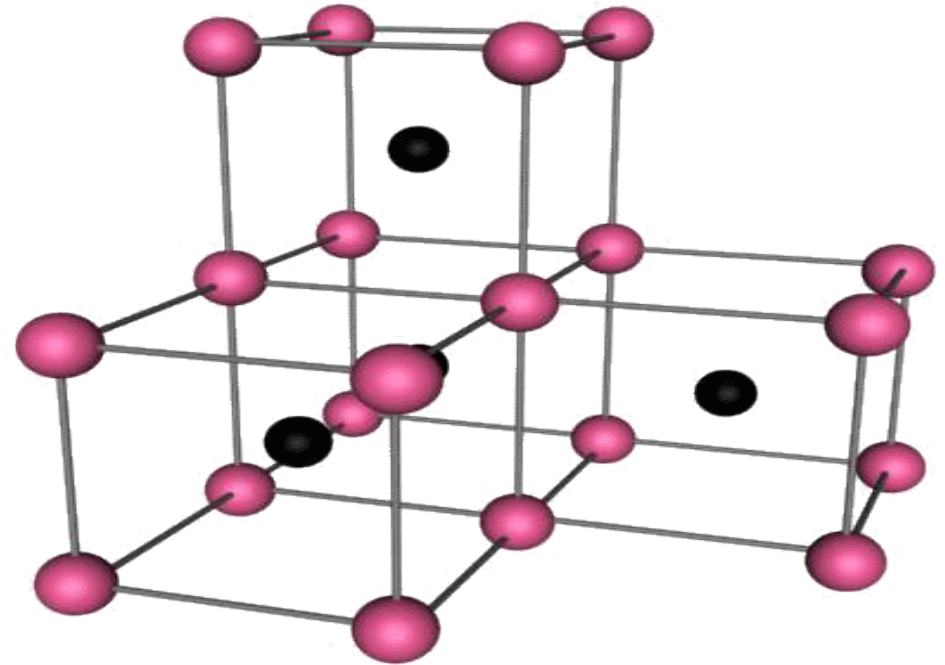

3-Hexagonal Close-Packed Str.

- This is another structure that is common, particularly in metals. In addition to the two layers of atoms which form the base and the upper face of the hexagon, there is also an intervening layer of atoms arranged such that each of these atoms rest over a depression between three atoms in the base.

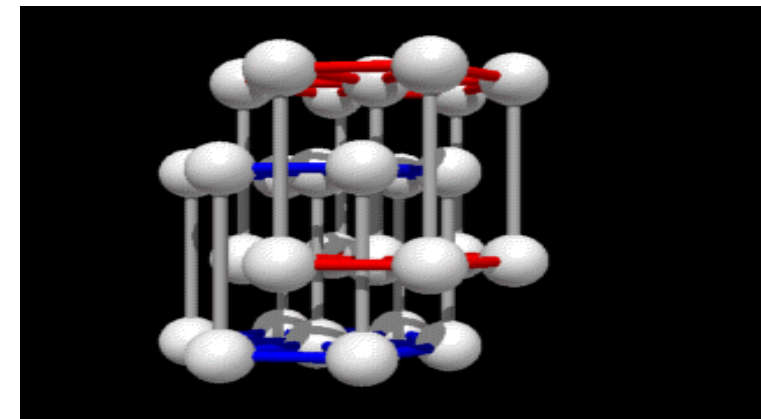
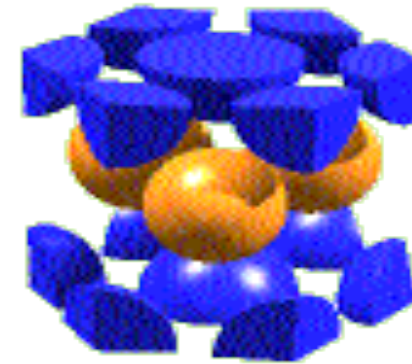

Hexagonal Close-packed Structure

Bravais Lattice : Hexagonal Lattice
He, Be, Mg, Hf, Re (Group II elements)
ABABAB Type of Stacking

$a=b$ $a=120$, $c=1.633a$,
basis : $(0,0,0)$ $(\frac{2}{3}a, \frac{1}{3}a, \frac{1}{2}c)$

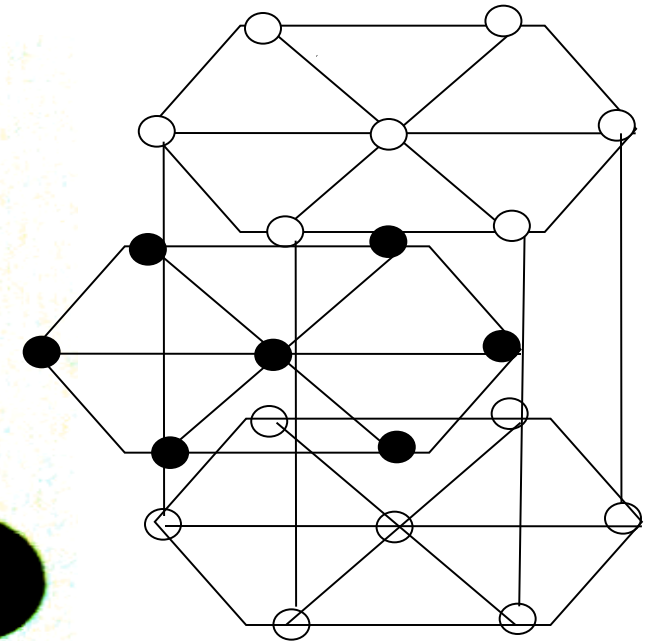
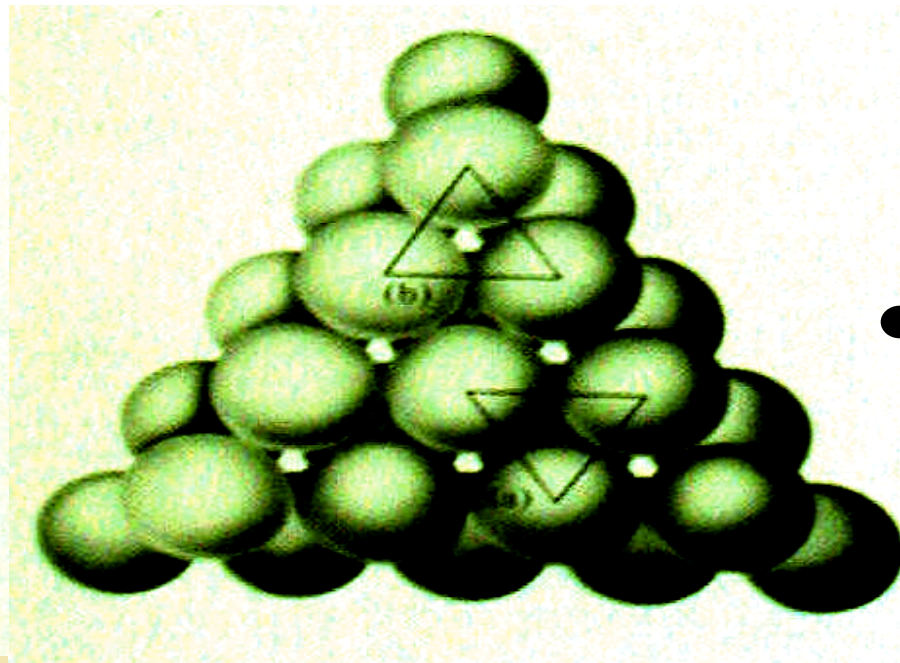
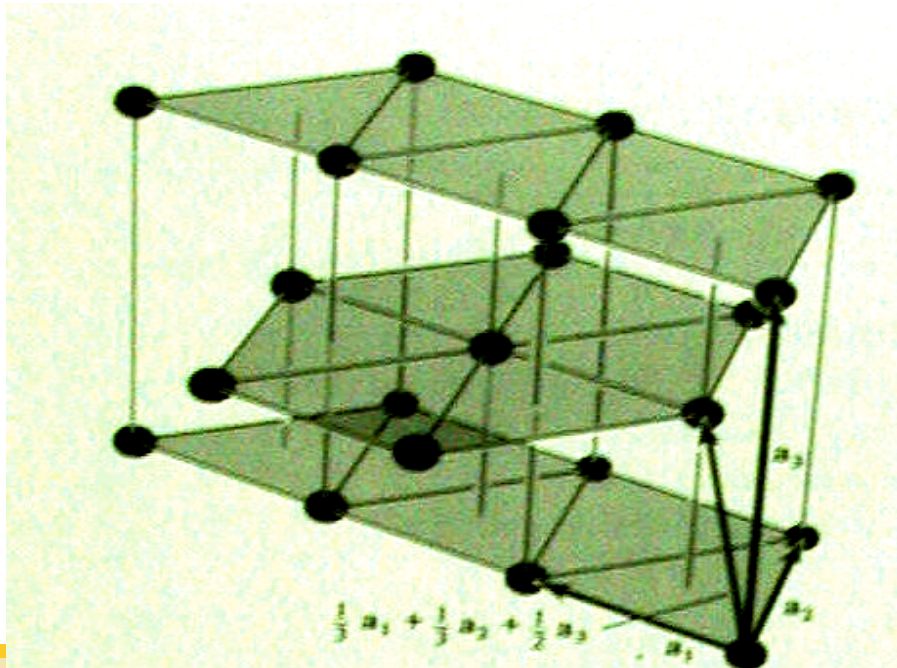

Packing

Close pack

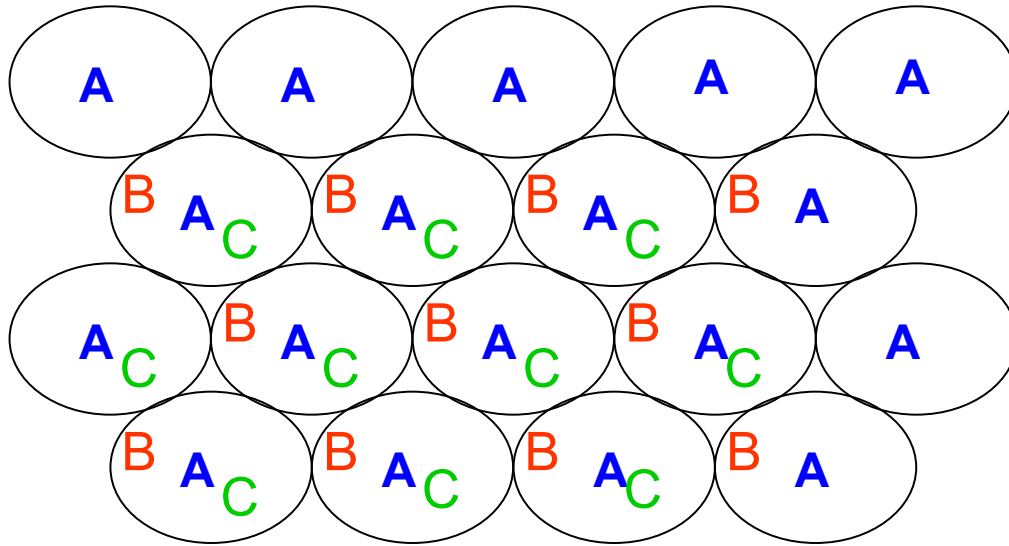

Sequence ABABAB..
-hexagonal close pack

Sequence ABCABCAB..
-face centered cubic close pack

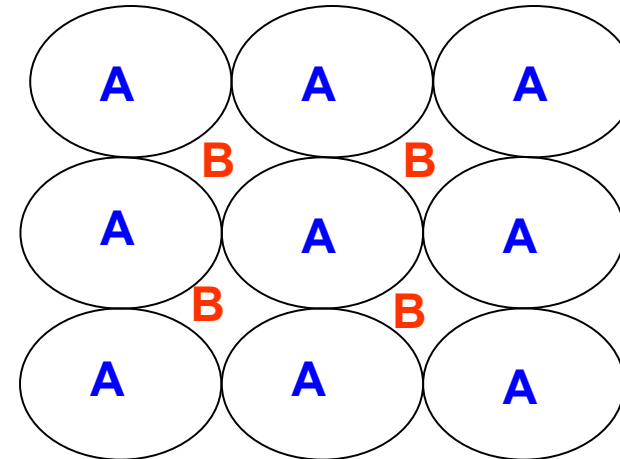

Sequence AAAA...
- simple cubic

Sequence ABAB...
- body centered cubic

4 - Diamond Structure

- The diamond lattice is consist of two interpenetrating face centered bravais lattices.
- There are eight atom in the structure of diamond.
- Each atom bonds covalently to 4 others equally spread about atom in 3d.

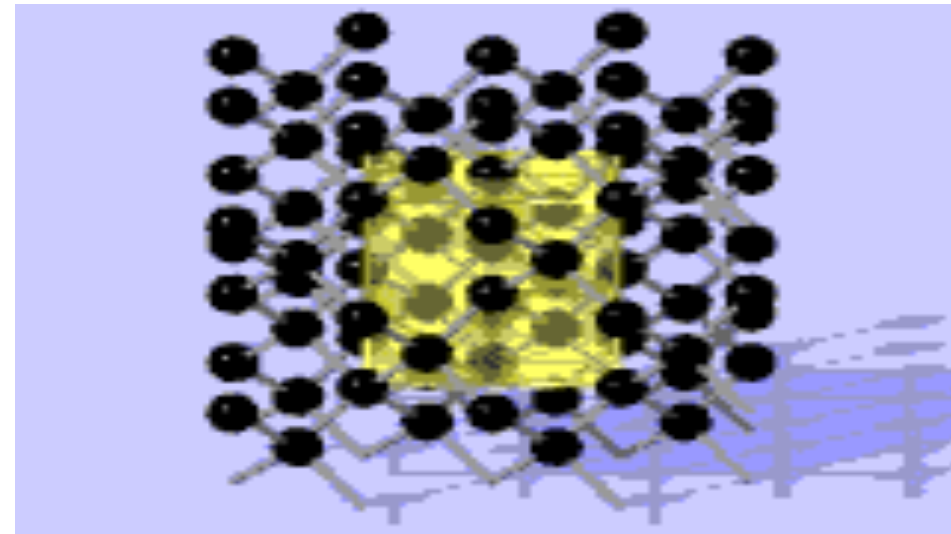
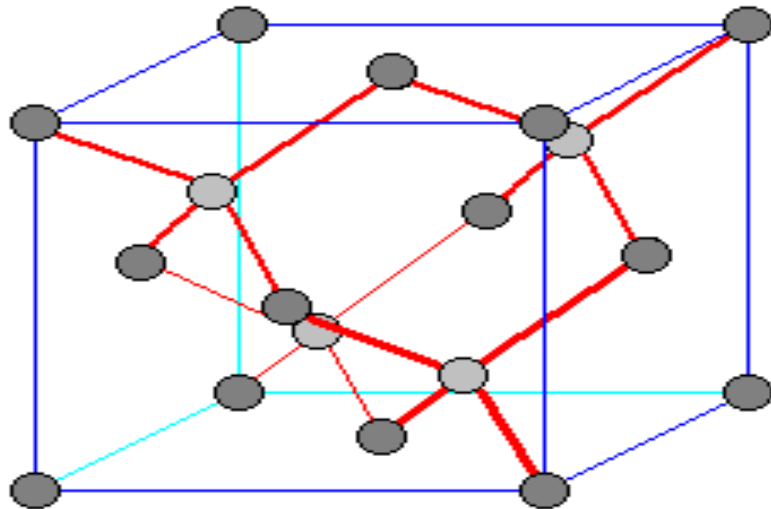

4 - Diamond Structure

- **The coordination number of diamond structure is 4.**
- **The diamond lattice is not a Bravais lattice.**
- **Si, Ge and C crystallizes in diamond structure.**

5- Zinc Blende

- **Zincblende has equal numbers of zinc and sulfur ions distributed on a diamond lattice so that each has four of the opposite kind as nearest neighbors. This structure is an example of a lattice with a basis, which must so described both because of the geometrical position of the ions and because two types of ions occur.**
- **AgI, GaAs, GaSb, InAs,**

5- Zinc Blende

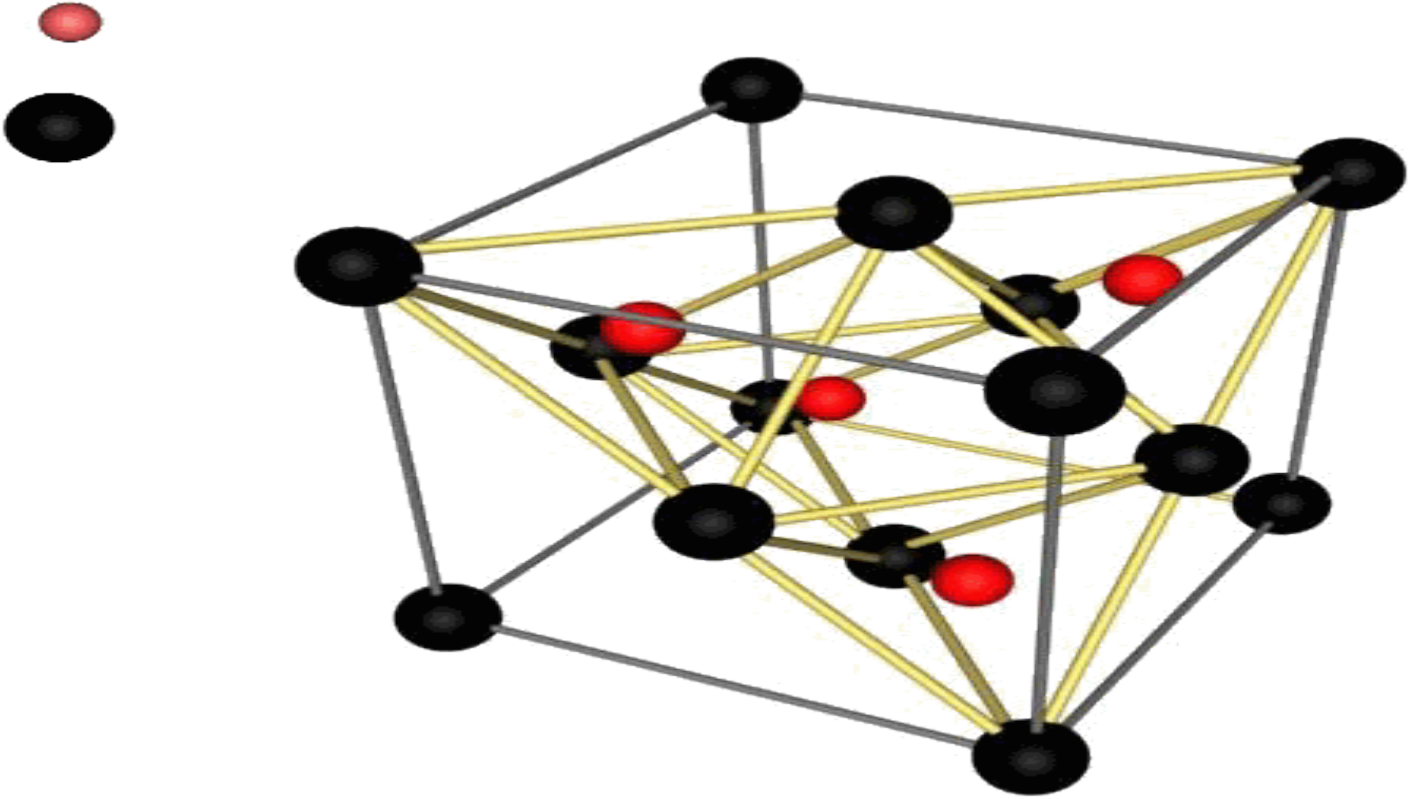

5- Zinc Blende

Zinc Blende is the name given to the mineral ZnS. It has a cubic close packed (face centred) array of S and the Zn(II) sit in tetrahedral (1/2 occupied) sites in the lattice.

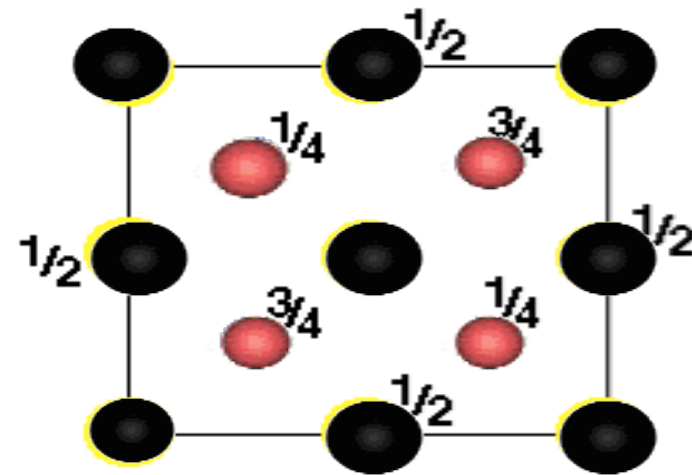
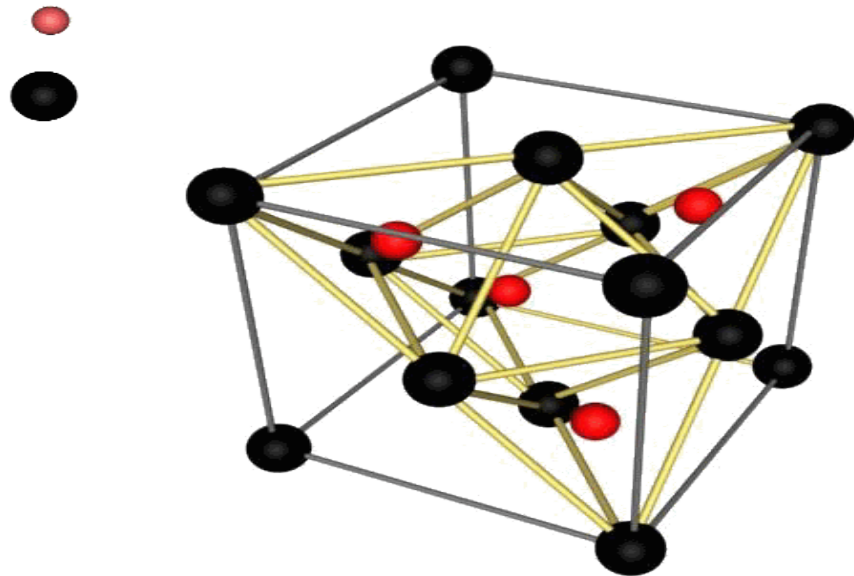

ELEMENTS OF SYMMETRY

- Each of the unit cells of the 14 Bravais lattices has one or more types of symmetry properties, such as inversion, reflection or rotation, etc.

