

Chapter 11: Computed Tomography

Slide set of 190 slides based on the chapter authored by
J Gelijns
of the IAEA publication (ISBN 978-92-0-131010-1):

*Diagnostic Radiology Physics:
A Handbook for Teachers and Students*

Objective:

To familiarize the student with CT scanning principles, acquisition and reconstruction, technology and image quality.



Slide set prepared
by S. Edyvean

- 11.1. Introduction
- 11.2. CT principles
- 11.3. The CT imaging system
- 11.4. Image reconstruction and processing
- 11.5. Acquisition
- 11.6. Computed tomography image quality

Bibliography

11.1 INTRODUCTION

- ❑ Clinical Computed Tomography (CT) was introduced in 1971 - limited to axial imaging of the brain in neuroradiology
- ❑ It developed into a versatile 3D whole body imaging modality for a wide range of applications in for example
 - oncology, vascular radiology, cardiology, traumatology and interventional radiology.
- ❑ Computed tomography can be used for
 - diagnosis and follow-up studies of patients
 - planning of radiotherapy treatment
 - screening of healthy subpopulations with specific risk factors.

11.1 INTRODUCTION

- Nowadays dedicated CT scanners are available for special clinical applications, such as
 - For radiotherapy planning - these CT scanners offer an extra wide bore, allowing the CT scans to be made with a large field of view.
 - The integration of CT scanners in multi modality imaging applications, for example by integration of a CT scanner with a PET scanner or a SPECT scanner.

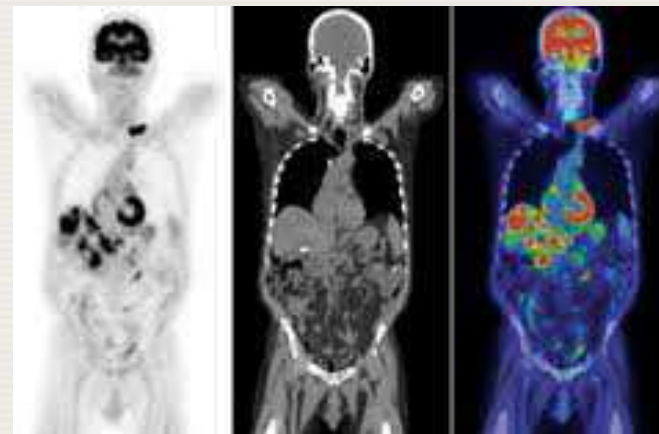

11.1 INTRODUCTION

- Other new achievements for dedicated diagnostic imaging new achievements concerns for example the development of a dual source CT scanner (a CT scanner that is equipped with two X-ray tubes), and a volumetric CT scanner (a 320 detector row CT scanner that allows for scanning entire organs within one rotation).

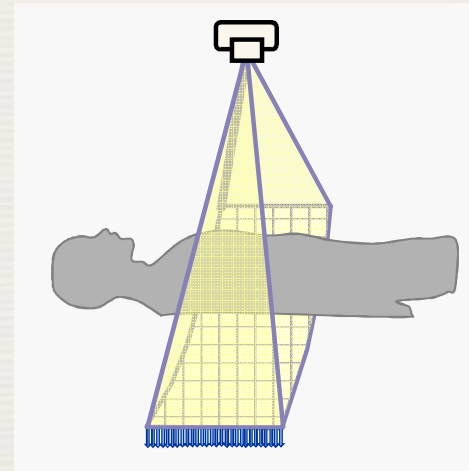
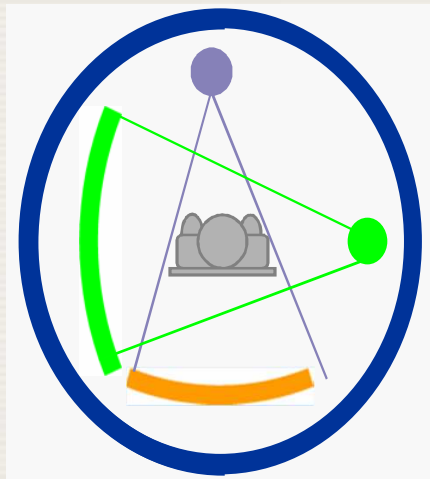

11.1 INTRODUCTION

- ❑ CT scanning is perfectly suited for 3D imaging and used in, for example, brain, cardiac, musculoskeletal, and whole body CT imaging
- ❑ The images can be presented as impressive colored 3D rendered images, but radiologists usually rely more on black and white, 2D images, being either the 2D axial images, or 2D reformats.

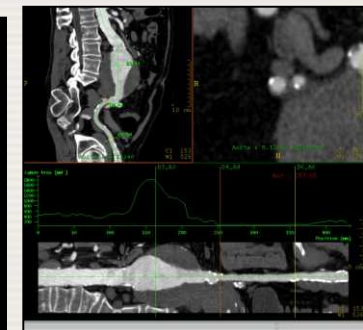
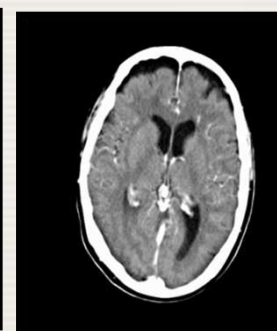
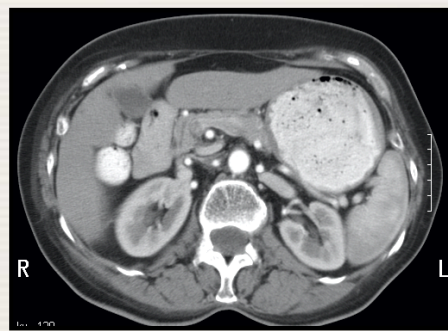
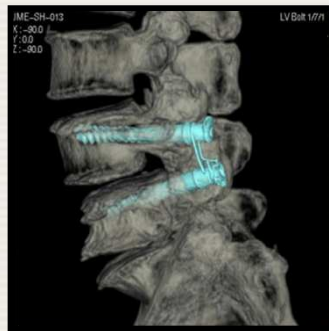

11.2 CT PRINCIPLES

11.2.1. X-ray projection, attenuation and acquisition of transmission profiles

- The purpose of a computed tomography acquisition is to measure x ray transmission through a patient for a large number of views.

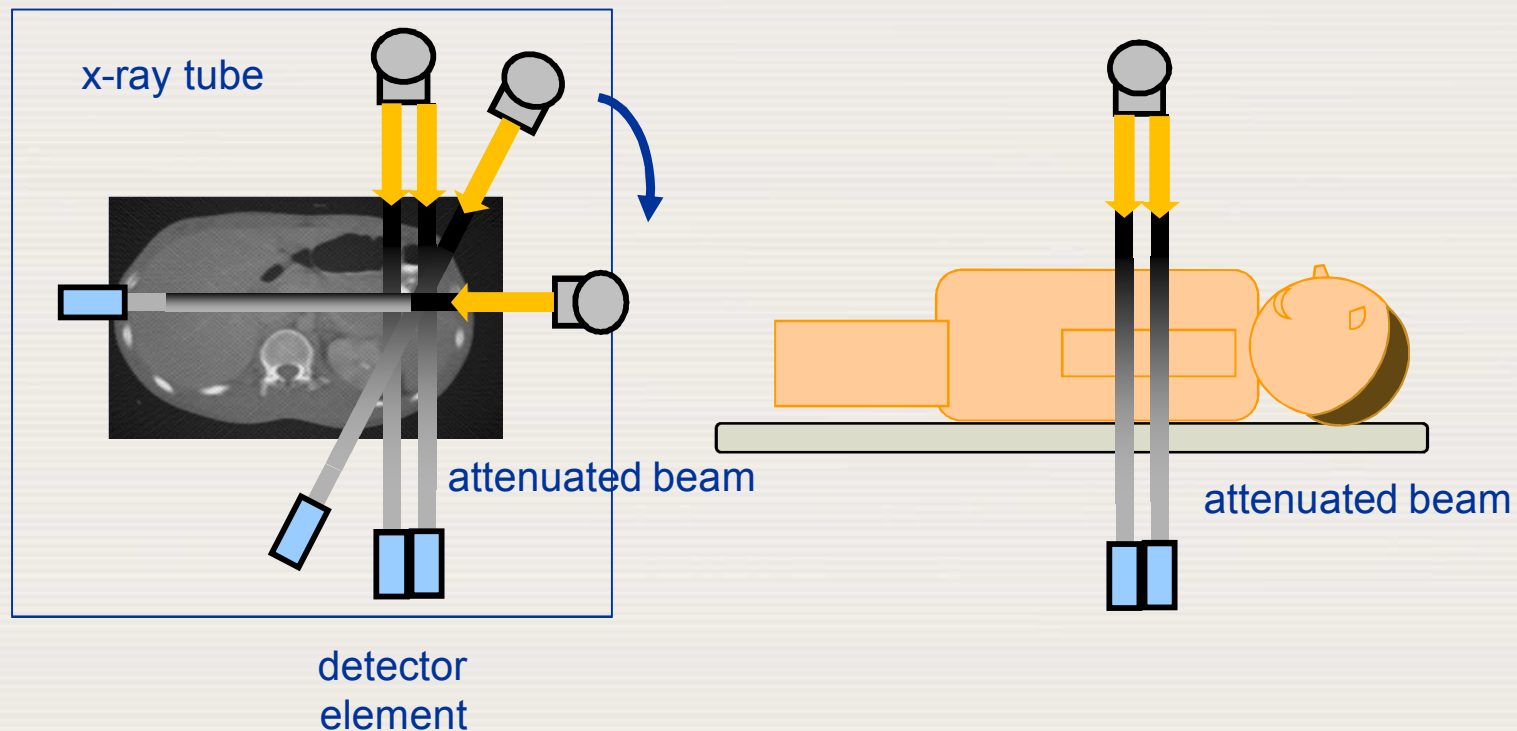

11.2 CT PRINCIPLES

11.2.1. X-ray projection, attenuation and acquisition of transmission profiles

- Different views are achieved in computed tomography primarily by using
 - detectors with hundreds of detector elements along the detector arc (generally 800-900 detector elements),
 - by rotation of the x ray tube around the patient, taking about 1000 angular measurements
 - and by tens or even hundreds of detector rows aligned next to each other along the axis of rotation

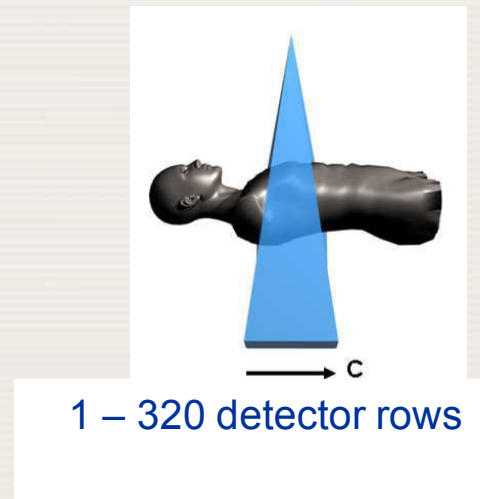
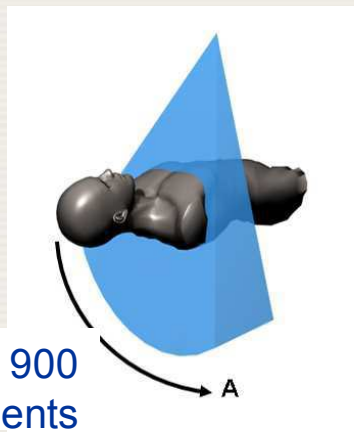

11.2 CT PRINCIPLES

11.2.1. X-ray projection, attenuation and acquisition of transmission profiles

- The values that are assigned to the pixels in a CT image are associated with the average linear attenuation coefficient μ (m^{-1}) of the tissue represented within that pixel.
- The linear attenuation coefficient (μ) depends on the composition of the material, the density of the material, and the photon energy as seen in Beer's law:

$$I(x) = I_0 e^{-\mu x}$$

- where $I(x)$ is the intensity of the attenuated X ray beam,
- I_0 the unattenuated X ray beam,
- and x the thickness of the material.

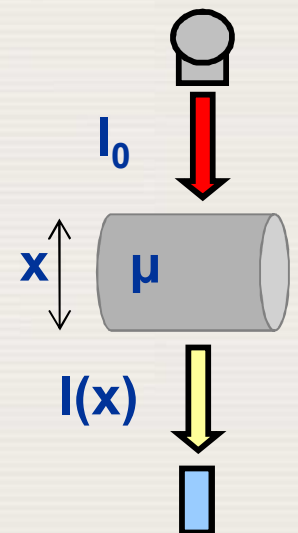

11.2 CT PRINCIPLES

11.2.1. X-ray projection, attenuation and acquisition of transmission profiles

- ❑ Beer's law only describes the attenuation of the primary beam and does not take into account the intensity of scattered radiation that is generated.
- ❑ For poly-energetic X ray beams Beer's law should strictly be integrated over all photon energies in the X ray spectrum.
- ❑ In the back projection methodologies developed for CT reconstruction algorithms, this is generally not implemented
 - Instead typically a pragmatic solution is to assume where Beer's law can be applied using one value representing the average photon energy of the X ray spectrum. This assumption causes inaccuracies in the reconstruction and leads to the beam hardening artefact.

11.2 CT PRINCIPLES

11.2.1. X-ray projection, attenuation and acquisition of transmission profiles

- As an X ray beam is transmitted through the patient, different tissues are encountered with different linear attenuation coefficients.
- The intensity of the attenuated X ray beam, transmitted a distance d , can be expressed as:

$$I(d) = I_0 e^{-\int_0^d \mu(x) dx}$$

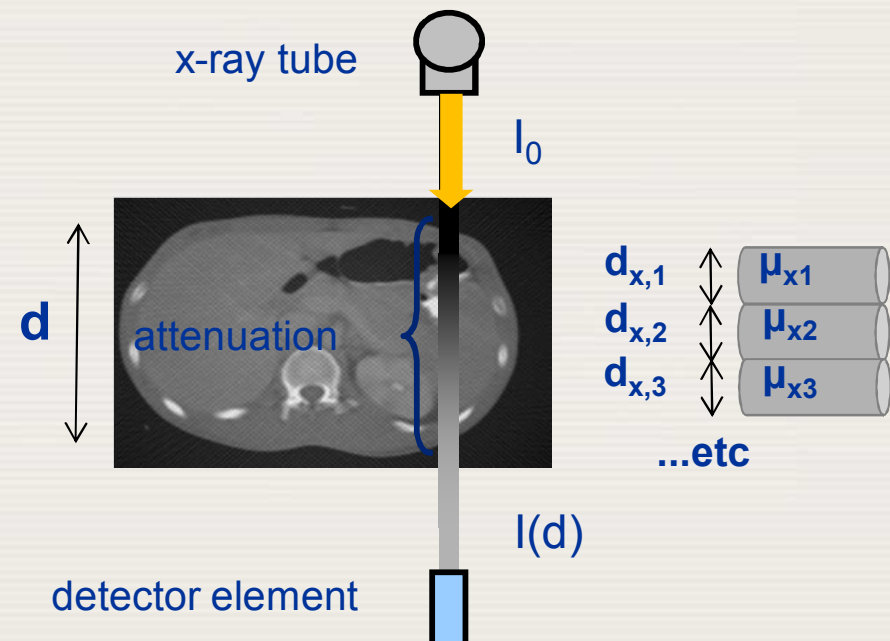

11.2 CT PRINCIPLES

11.2.1. X-ray projection, attenuation and acquisition of transmission profiles

- A CT image is composed of a matrix of pixels representing the average linear attenuation co-efficient in the associated volume elements (voxels).

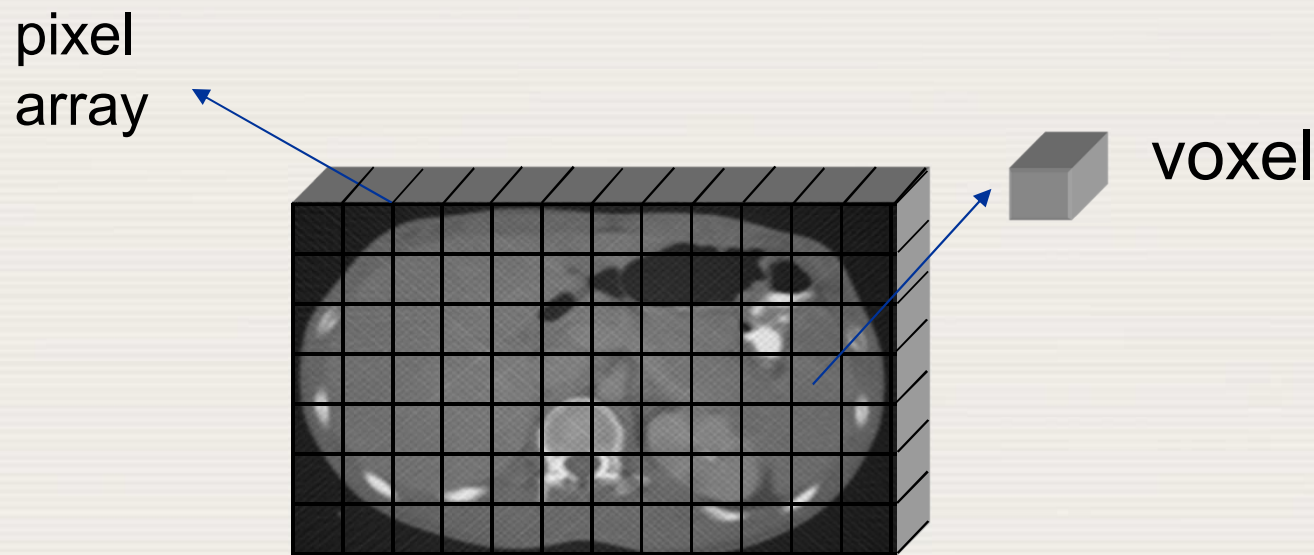

11.2 CT PRINCIPLES

11.2.1. X-ray projection, attenuation and acquisition of transmission profiles

- ❑ Illustration: a simplified 4 x 4 matrix representing the measurement of transmission along one line.
- ❑ Each element in the matrix can in principle have a different value of the associated linear attenuation coefficient.
- ❑ The equation for the attenuation can be expressed as:

$$I(d) = I_0 e^{-\sum_{i=1}^{i=4} \mu_i \Delta x}$$

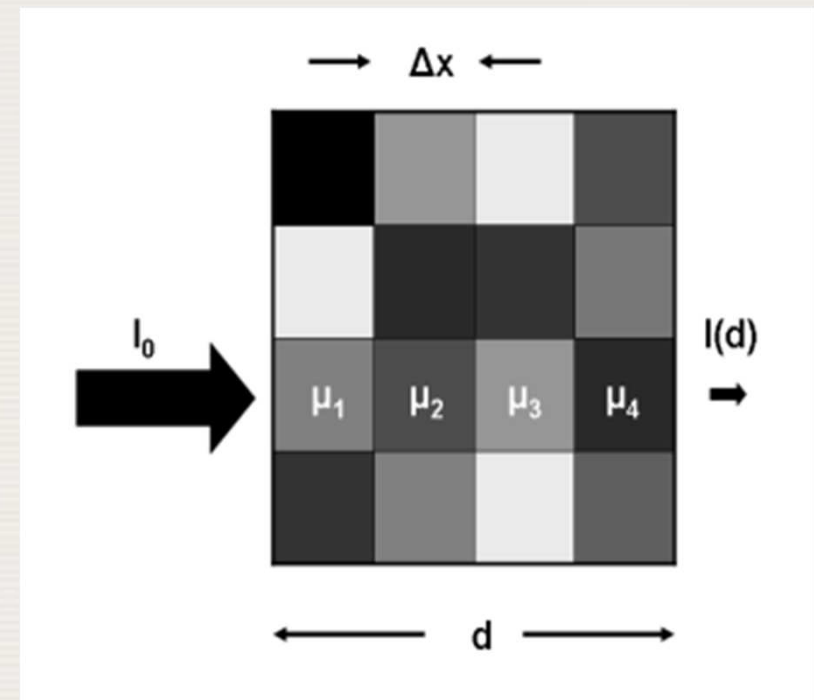

11.2 CT PRINCIPLES

11.2.1. X-ray projection, attenuation and acquisition of transmission profiles

- ❑ From the above it can be seen that the basic data needed for CT is the intensity of the attenuated and unattenuated X ray beam, respectively $I(d)$ and I_0 , and that this can be measured.
- ❑ Image reconstruction techniques can then be applied to derive the matrix of linear attenuation coefficients, which is the basis of the CT image.

11.2 CT PRINCIPLES

11.2.2. Hounsfield Units

- In CT the matrix of reconstructed linear attenuation coefficients (μ_{material}) is transformed into a corresponding matrix of Hounsfield units ($\text{HU}_{\text{material}}$), where the HU scale is expressed relative to the linear attenuation coefficient of water at room temperature (μ_{water}):

$$\text{HU}_{\text{material}} = \frac{\mu_{\text{material}} - \mu_{\text{water}}}{\mu_{\text{water}}} \times 1000$$

- It can be seen that
- $\text{HU}_{\text{water}} = 0$ as ($\mu_{\text{material}} = \mu_{\text{water}}$),
 - $\text{HU}_{\text{air}} = -1000$ as ($\mu_{\text{material}} = 0$)
 - $\text{HU}=1$ is associated with 0.1% of the linear attenuation coefficient of water.

11.2 CT PRINCIPLES

11.2.2. Hounsfield Units

□ Typical values for body tissues.

- The actual value of the Hounsfield unit depends on the composition of the tissue or material, the tube voltage, and the temperature.

Substance	Hounsfield unit (HU)
Compact bone	+1000 (+300 to +2500)
Liver	+ 60 (+50 to +70)
Blood	+ 55 (+50 to +60)
Kidneys	+ 30 (+20 to +40)
Muscle	+ 25 (+10 to +40)
Brain, grey matter	+ 35 (+30 to +40)
Brain, white matter	+ 25 (+20 to +30)
Water	0
Fat	- 90 (-100 to -80)
Lung	- 750 (-950 to -600)
Air	- 1000

CT number window

❑ Hounsfield units are usually visualized in an eight bit grey scale offering only 128 grey values.

❑ The display is defined using

- Window level (WL) as CT number of mid-grey
- Window width (WW) as the number of HU from black -> white

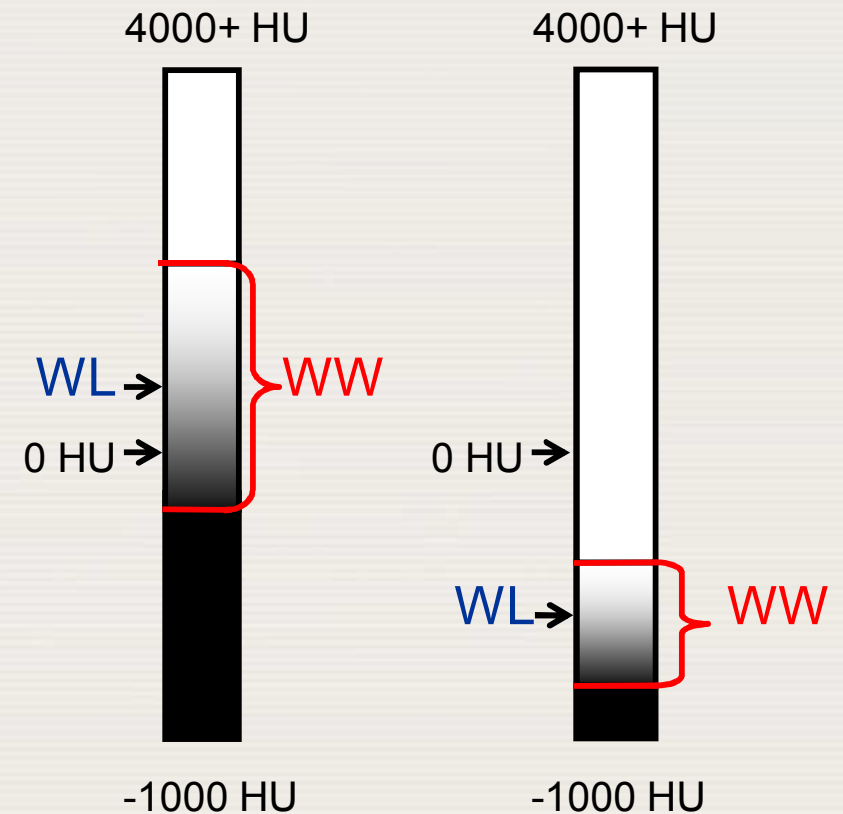

11.2 CT PRINCIPLES

11.2.2. Hounsfield Units

- ❑ The choice of WW and WL is dictated by clinical need
- ❑ Optimal visualization of the tissues of interest in the CT image can only be achieved by selecting the most appropriate window width and window level.
- ❑ Different settings of the WW and WL are used to visualize for example soft tissue, lung tissue or bone.

11.2 CT PRINCIPLES

11.2.2. Hounsfield Units

- Same image data at different WL and WW

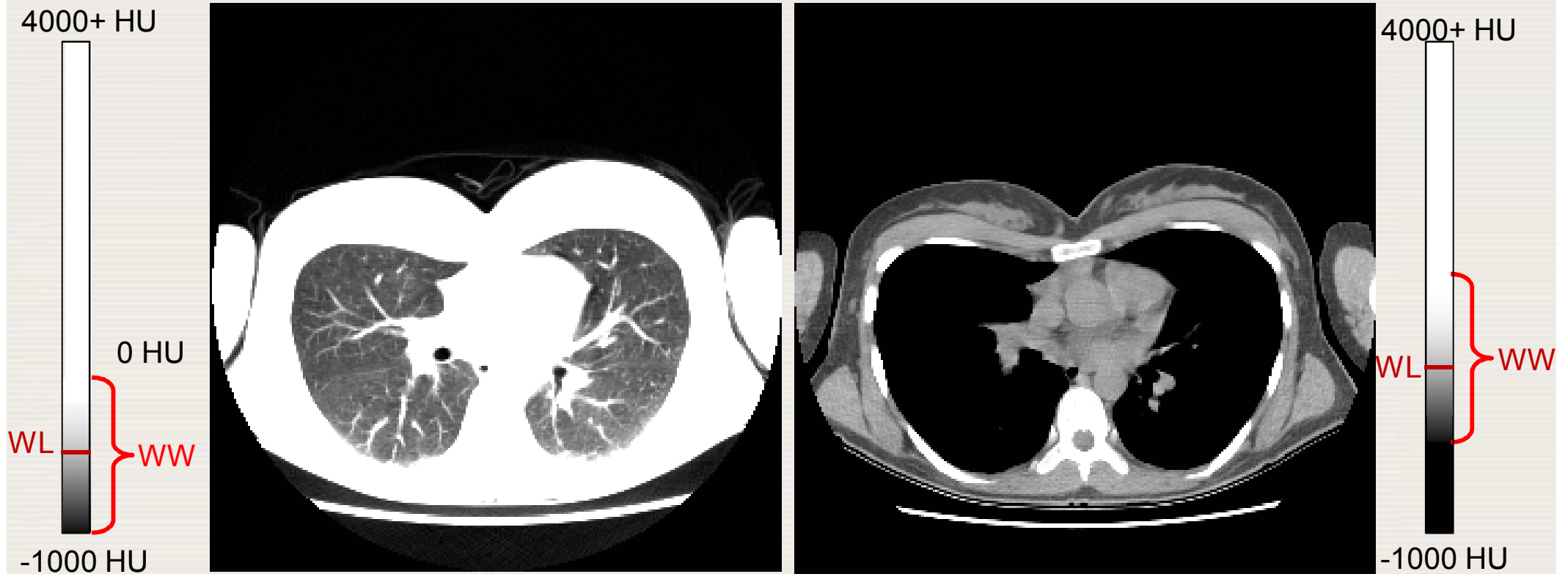

WL -593, WW 529

WL -12, WW 400



11.2 CT PRINCIPLES

11.2.2. Hounsfield Units

- ❑ The minimum bit depth that should be assigned to the Hounsfield unit is 12, this enables creating a Hounsfield scale that runs from -1024 HU to $+3071$ HU, thus covering most clinically relevant tissues.
- ❑ A wider Hounsfield scale with a bit depth of 14 is useful for extending the Hounsfield unit scale upwards to $+15359$ HU thus making it compatible with materials that have a high density and high linear attenuation coefficient.
- ❑ An extended Hounsfield scale allows for better visualisation of body parts with implanted metal objects such as stents, orthopaedic prosthesis's, dental- or cochlear implants.

11.2 CT PRINCIPLES

11.2.2. Hounsfield Units

- ❑ From the definition of the Hounsfield unit
 - for substances and tissues, except for water and air, variations of the Hounsfield units occur when they are derived at different tube voltages.
- ❑ The reason is that as a function of photon energy different substances and tissues exhibit a non linear relationship of their linear attenuation coefficient relative to water.
- ❑ This effect is most notable for substances and tissues that have a relatively high (effective) atom number such as contrast enhanced blood (iodine) and bone (calcium).

11.2 CT PRINCIPLES

11.2.2. Hounsfield Units

- ❑ In clinical practice, considerable deviations between the expected and the actually observed Hounsfield unit may occur.
- ❑ Causes for such inaccuracies may be the dependence of the Hounsfield unit for example on the reconstruction filter, on the size of the scanned field of view, and on the position within the scanned field of view.
- ❑ In addition, image artefacts may have an effect on the accuracy of the Hounsfield units.

11.2 CT PRINCIPLES

11.2.2. Hounsfield Units

- ❑ When performing clinical studies over time, one should take into account that even on the same scanner, with time, a certain drift of the Hounsfield units may occur.
- ❑ In multicenter studies that involve different CT scanners, significant variations in the observed Hounsfield units may also occur between centers.
- ❑ Therefore, quantitative imaging in computed tomography requires special attention and often additional calibrations of the CT scanners are needed.

11.3 THE CT IMAGING SYSTEM

11.3.1 Historical and current acquisition configurations

- ❑ After the pre-clinical research and development during the early 1970's, CT developed rapidly as an indispensable imaging modality in diagnostic radiology.
- ❑ Most of the modern CT technology that is being used in clinical practice nowadays was already described at the end of the year 1983.

11.3 THE CT IMAGING SYSTEM

11.3.1 Historical and current acquisition configurations

- The development of multi detector-row CT and multi-source CT was described in a 1980[^] United States patent
 - “the figure is a simplified plan view ... in which three X-ray sources are employed in conjunction with three corresponding rotating X-ray detectors”.

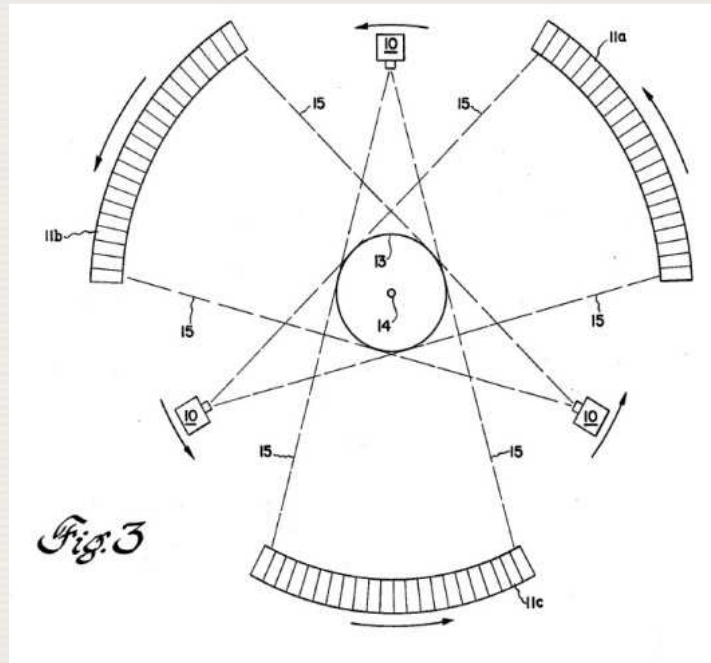

[^] #4196352, W.H. Berninger, R.W. Redington, GE company.

11.3 THE CT IMAGING SYSTEM

11.3.1 Historical and current acquisition configurations

- The acquisition technique of helical CT was described in a Patent in 1983[^].
 - “the figure is an illustrative representation for explaining the helically-scanning method....by continuous transportation of the table-couch”

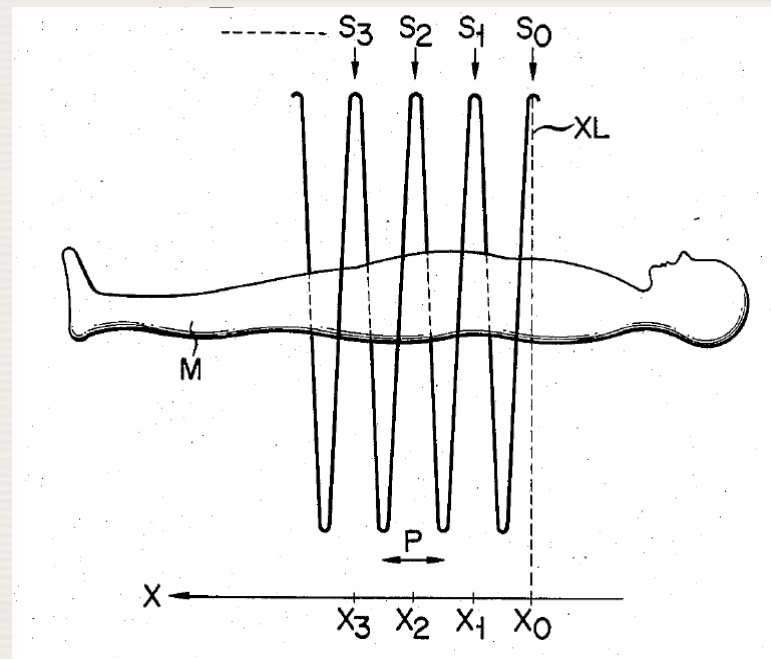

[^] #4630202, Issei Mori, Tochigi, Japan.

11.3 THE CT IMAGING SYSTEM

11.3.1 Historical and current acquisition configurations

- ❑ Currently most scanners are helical, multi detector row CT scanners
- ❑ The technologies of dual source and volumetric CT scanning have however also been implemented on a wide scale.

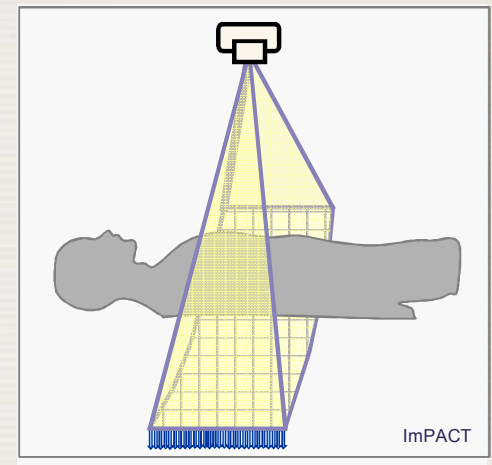
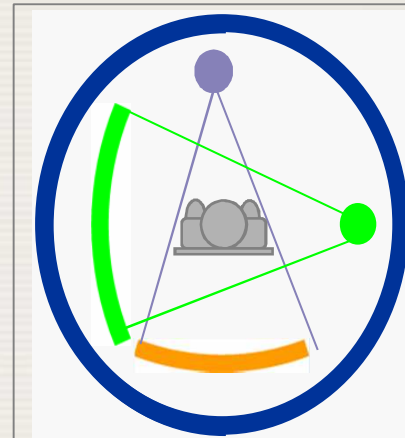
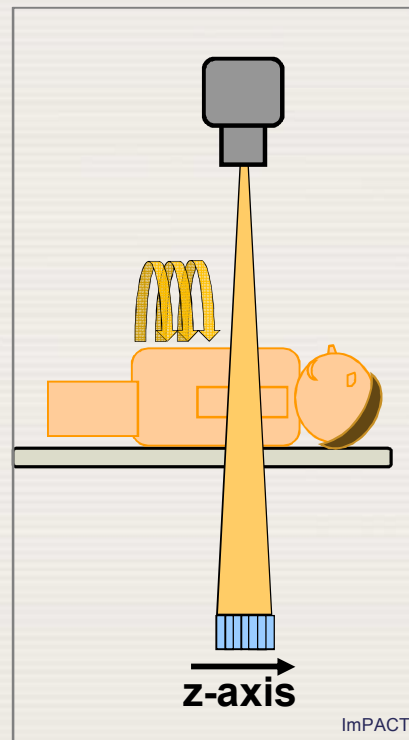
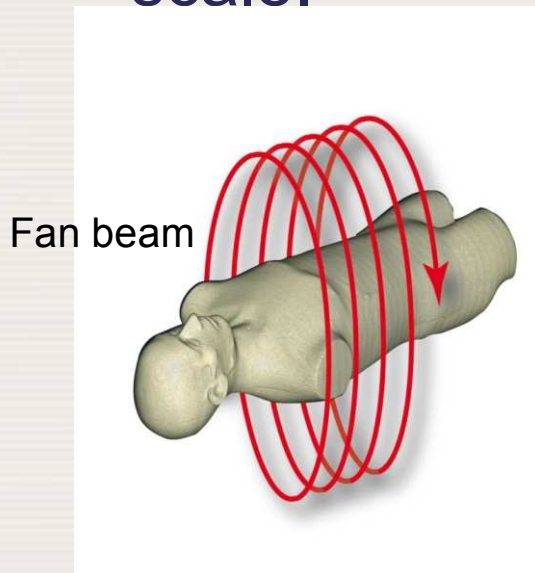

11.3 THE CT IMAGING SYSTEM

11.3.1 Historical and current acquisition configurations

Technological advances, 1985 - 2007

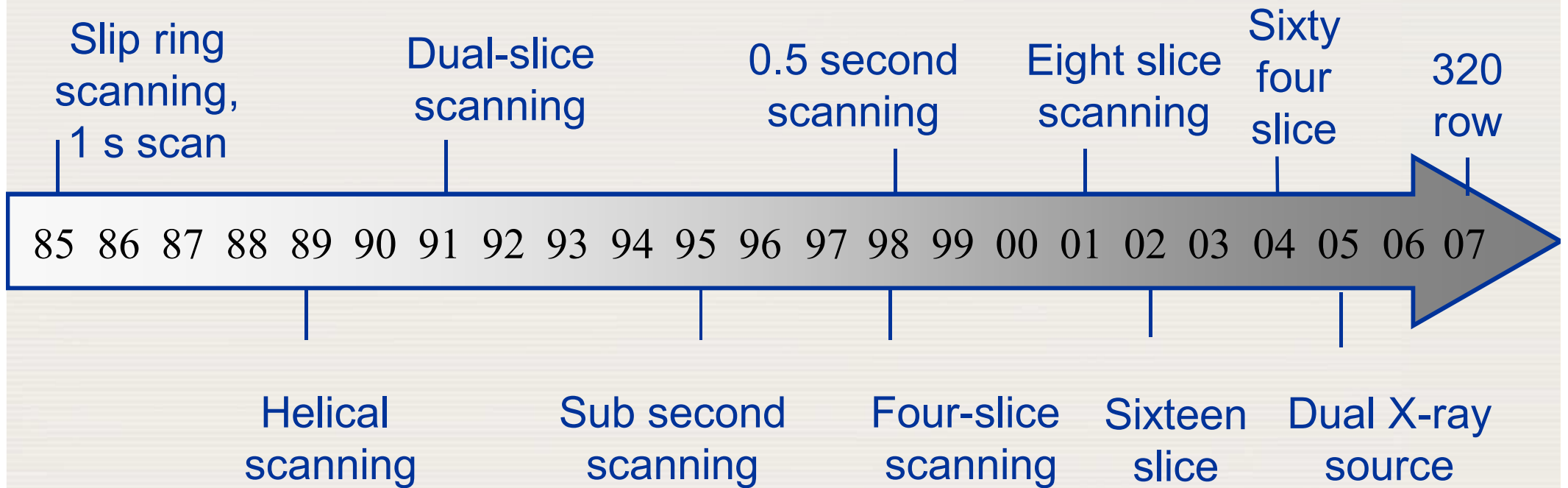

ImPACT



11.3 THE CT IMAGING SYSTEM

11.3.2 Gantry and table

- The CT gantry contains all devices that are required to record transmission profiles of a patient, since transmission profiles have to be recorded under different angles these devices are mounted on a support that can be rotated.

11.3 THE CT IMAGING SYSTEM

11.3.2 Gantry and table

- On the rotating part of the gantry are mounted for example
 - the X-ray tube, the detector, the high voltage generator for the X-ray tube, the (water or air) cooling of the X-ray tube, the data acquisition system, the collimator, and the beam shaping filters.

- T X-ray tube
- D X-ray detectors
- X X-ray beam
- R Gantry rotation

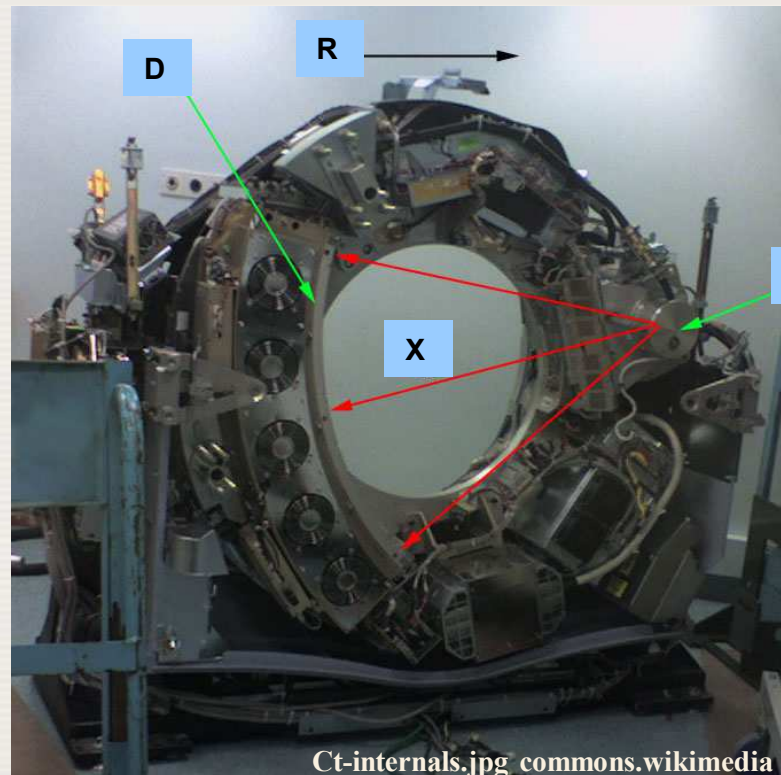

11.3 THE CT IMAGING SYSTEM

11.3.2 Gantry and table

- **Electrical power** is generally supplied to the rotating gantry through **contacts (brushes)** from stationary **slip rings**.
- **Projection profiles** are transmitted from the gantry to a computer usually by **wireless communication** (or **slip ring contacts**).

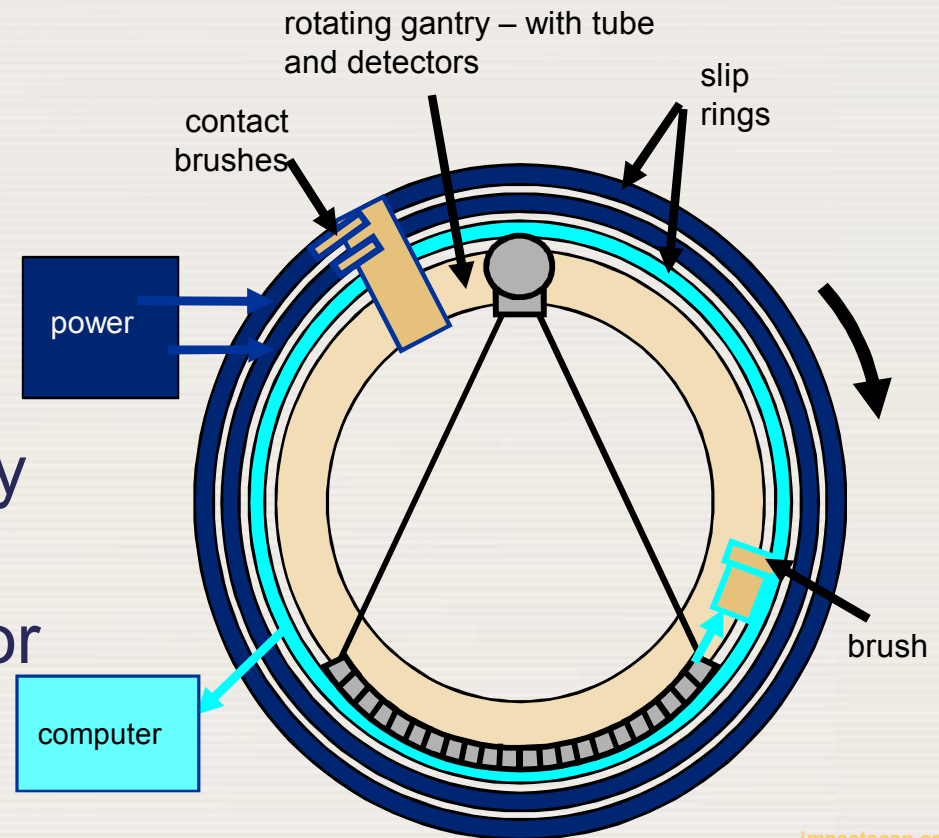

11.3 THE CT IMAGING SYSTEM

11.3.2 Gantry and table

- ❑ The position of the patient on the table can be
 - head first or feet first
 - supine or prone
- ❑ The position is usually recorded with the scan data.

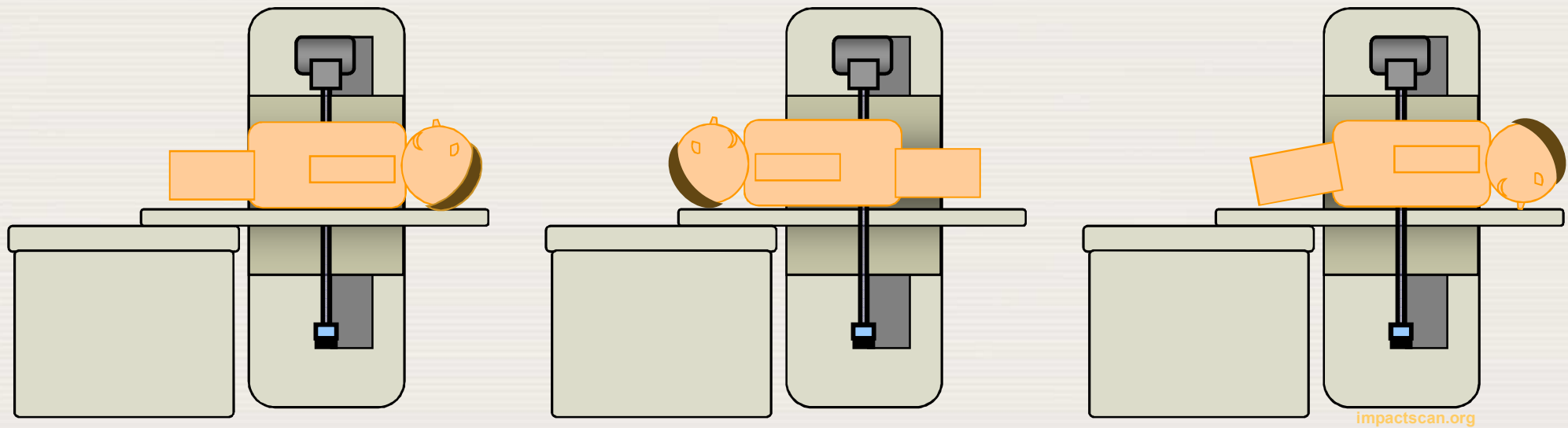

11.3 THE CT IMAGING SYSTEM

11.3.3 The X-ray tube and generator

- ❑ An x ray tube (with a rotating tungsten anode) and high voltage generator are used for generating the x ray beam.
- ❑ The beam is collimated to create the 'dose slice' (or 'cone')

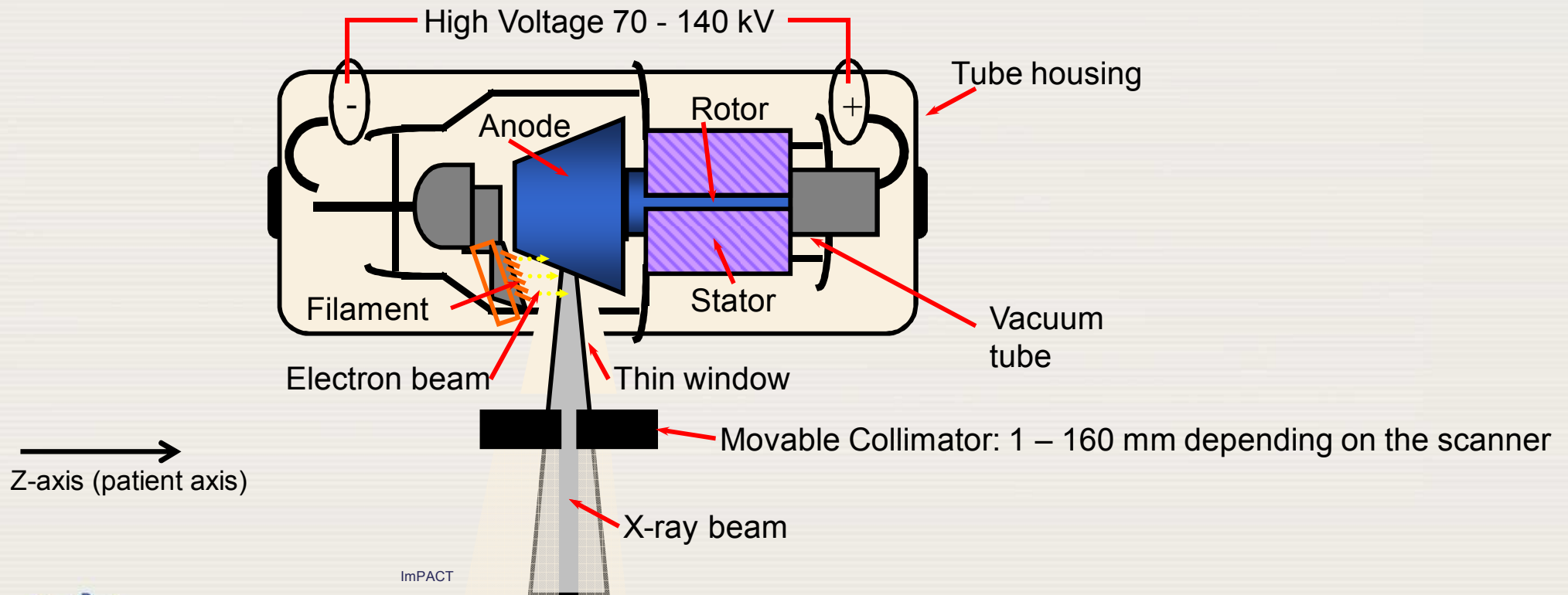

11.3 THE CT IMAGING SYSTEM

11.3.3 The X-ray tube and generator

- ❑ Rotation time, and the associated temporal resolution of CT scan, is limited due to the strong increase of centrifugal forces at shorter rotation times.
- ❑ In fast CT scanners with rotation times in the order of magnitude of 0.35 seconds, rotating parts are exposed to several tenths of g forces.

11.3 THE CT IMAGING SYSTEM

11.3.4 Collimation and filtration

- ❑ The X-ray beam is often referred to as a fan beam where the beam width along the longitudinal axis is small
- ❑ For multi-slice scanners where the longitudinal beam width is no longer small the X-ray beam is often referred to as 'cone beam'

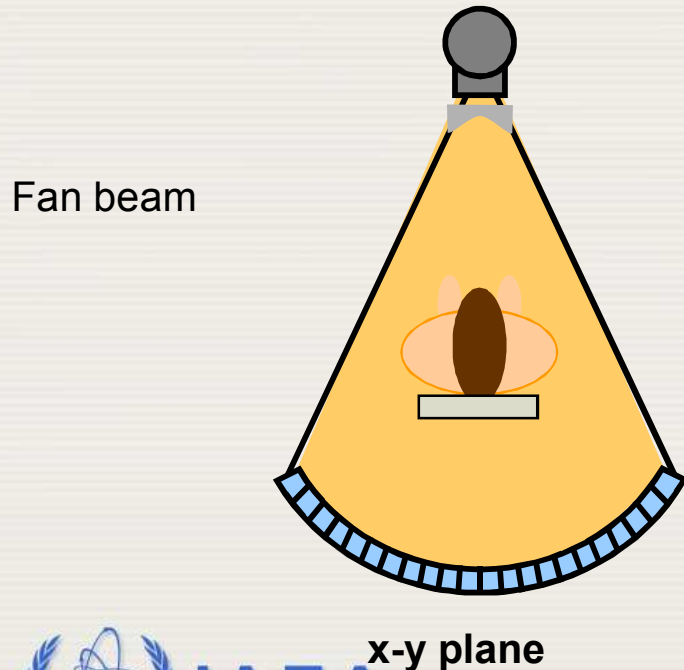

Side view approximates to parallel sides of beam for narrow beam scanners

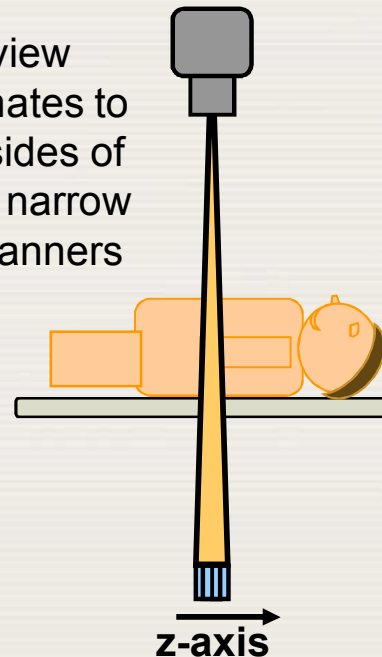

'cone beam' for wider beam multi-slice scanners

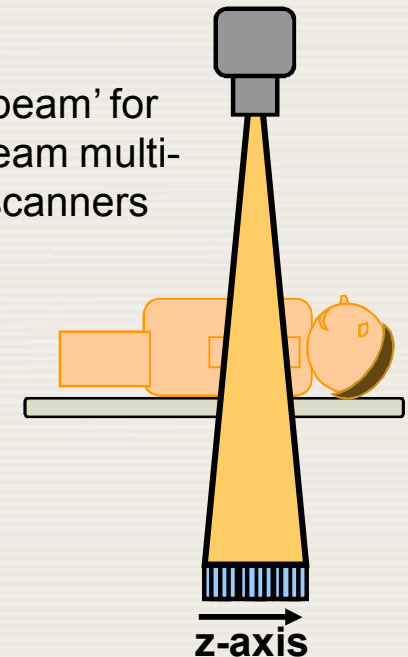

11.3 THE CT IMAGING SYSTEM

11.3.4 Collimation and filtration

- ❑ Beam shaping filters are being used to create a gradient in the intensity of the X-ray beam
 - They are sometimes called “bow-tie” filters
 - They are mounted close to the X-ray tube.
- ❑ The purpose of the beam shaping filter is to
 - reduce the dynamic range of the signal recorded by the CT detector
 - Reduce the dose to the periphery of the patient
 - Attempt to normalise the beam hardening of the beam – to aid with calibration

11.3 THE CT IMAGING SYSTEM

11.3.4 Collimation and filtration

- Schematic figure showing the fan beam, flat and beam shaping ('bow-tie') filters

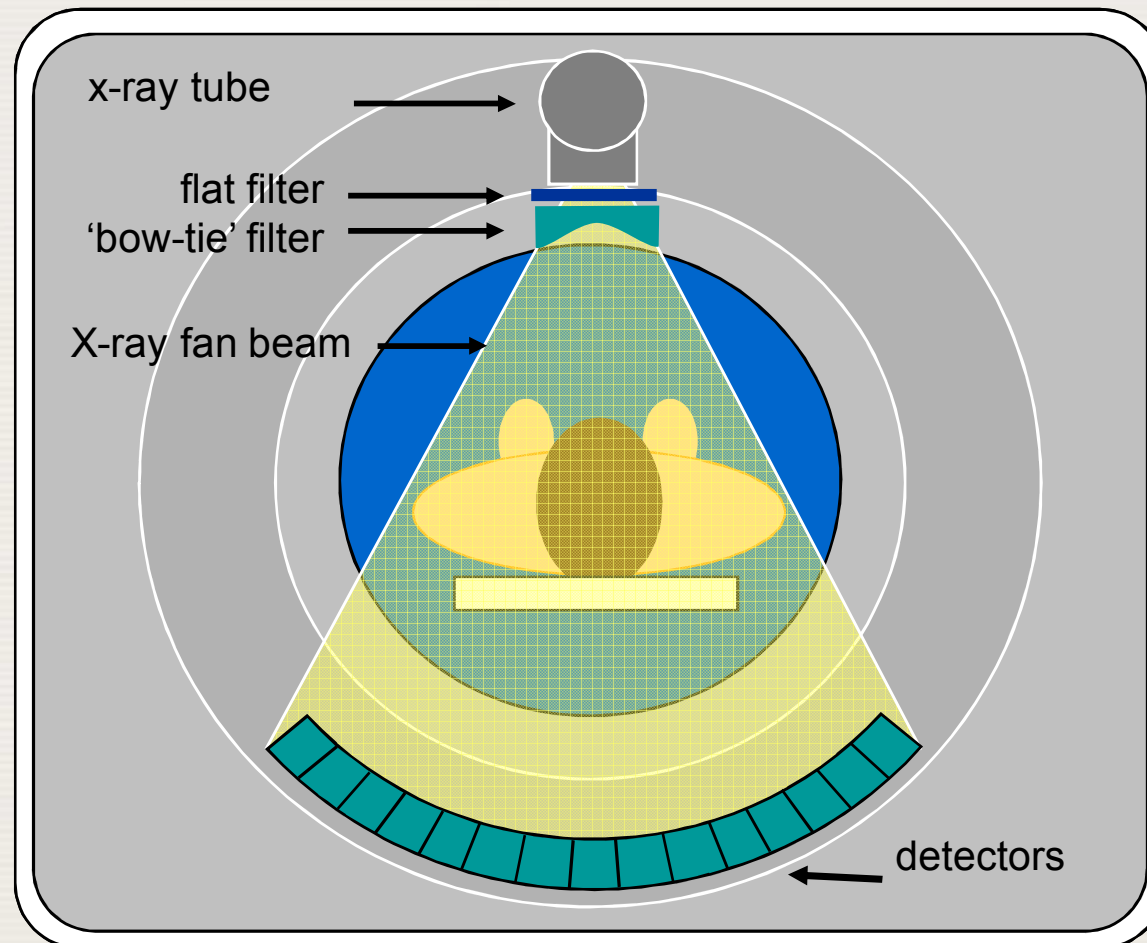

ImPACT

11.3 THE CT IMAGING SYSTEM

11.3.5 Detectors

- CT scanner detectors
 - ~ 800-1000 detector elements along the detector arc
 - 1 – 320 detectors along z-axis
- CT detectors are curved in the axial plane (x-y plane), and rectangular along the longitudinal axis (z-axis)

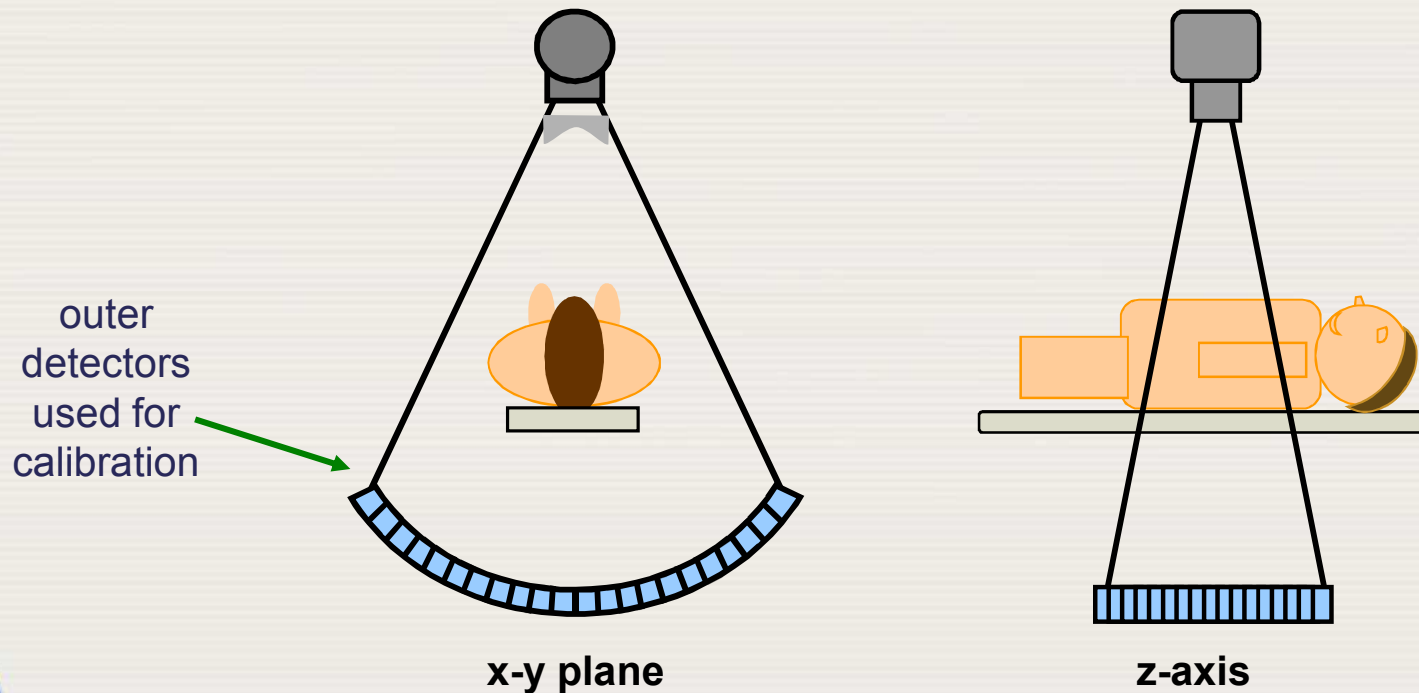

11.3 THE CT IMAGING SYSTEM

11.3.5 Detectors

- ❑ Xenon filled ionization chambers were used till ~ year 2000
 - Fewer ring artefacts
 - Lower detection efficiency
- ❑ Currently solid state detectors are used
 - better detection efficiency

Detector Type	Efficiency
Xenon gas filled	70%
Solid state	Approaching 100%

11.3 THE CT IMAGING SYSTEM

11.3.5 Detectors

- ❑ Solid state detectors are generally scintillators
 - the photons interact with the detector and generate light.
- ❑ The light is converted into an electrical signal by photodiodes
- ❑ An anti-scatter grid may be used

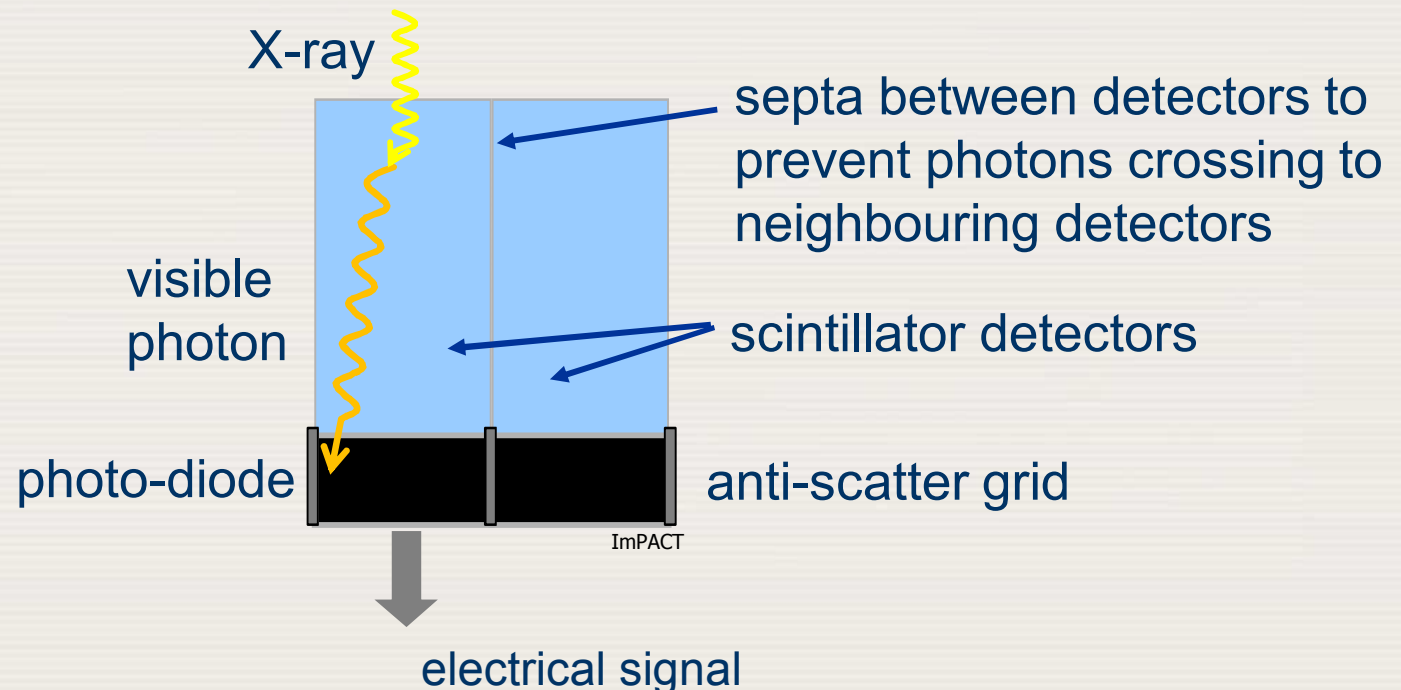

11.3 THE CT IMAGING SYSTEM

11.3.5 Detectors

- Essential physical characteristics of the CT detectors are
 - Good detection efficiency
 - Fast response (and little afterglow)
 - Good transparency for the generated light (to ensure optimal detection of the generated light by the photodiodes).

11.3 THE CT IMAGING SYSTEM

11.3.5 Detectors

- The septa and the strips of the anti scatter grid should be as small as possible, since they reduce the effective area of the detector and thus reduce the detection of X-rays.

Detector modules for a 4, 16, 64 and 320 slice CT scanner (left), the complete CT detector is composed of many detector modules (right)

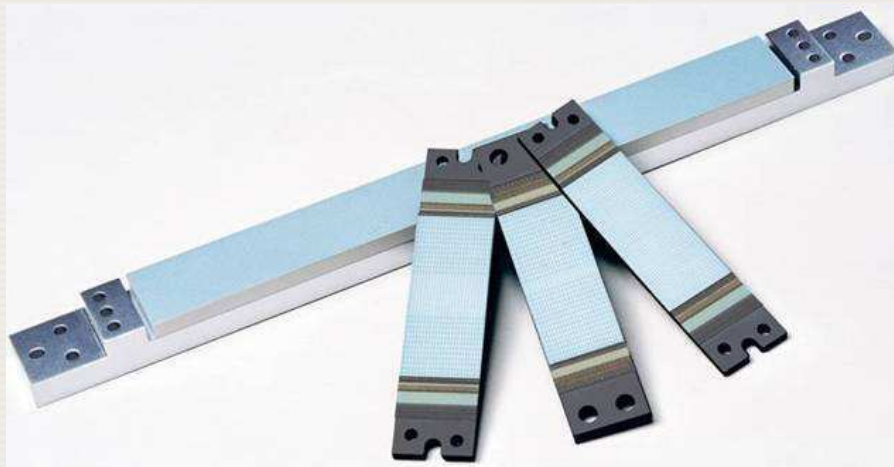

(Courtesy Toshiba Medical Systems)

11.3 THE CT IMAGING SYSTEM

11.3.5 Detectors

- Resolution in the reconstructed images depends on
 - The size of detector elements - along the detector arc and the z-axis
 - The angular separation of the projection

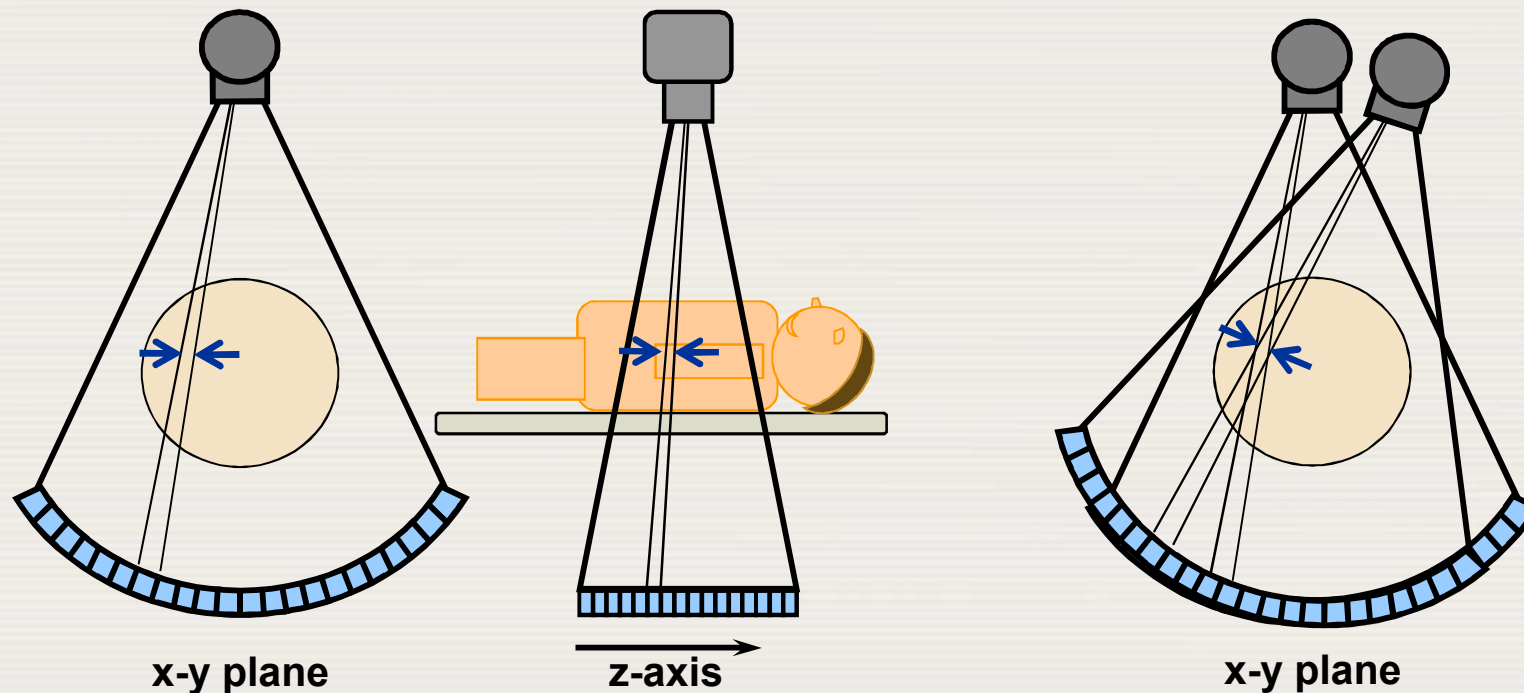

ImPACT

11.3 THE CT IMAGING SYSTEM

11.3.5 Detectors

- ❑ Detector sizes are the effective size at the iso-centre
- ❑ The minimum number of detector elements should be approximately $(2 \text{ FOV})/d$ to achieve a spatial resolution of d in the reconstructed image
 - ~ 800 detector elements are required to achieve a spatial resolution of 1 mm within a reconstructed image at a field of view of 400 mm
- ❑ Spatial resolution can be improved by use of the **quarter detector shift**
- ❑ It can also be improved by the use of a **dynamic focal spot**

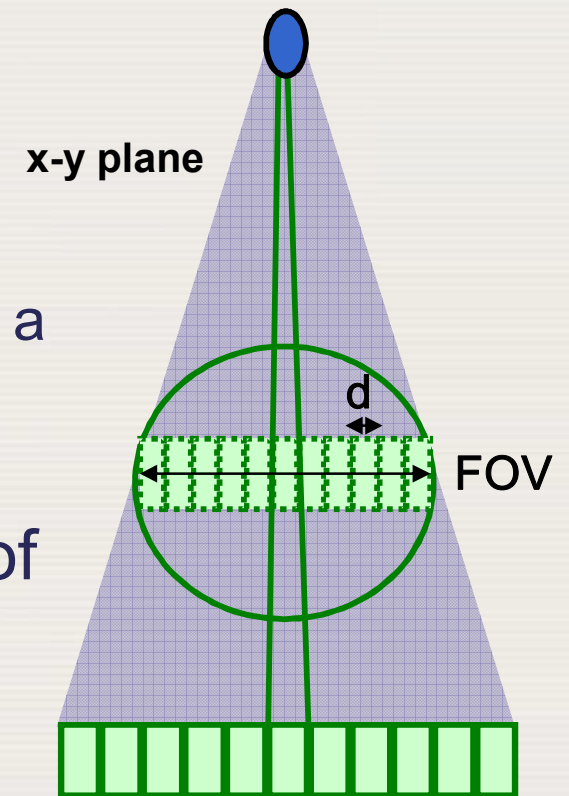

Schematic view of detector sizes

ImPACT

11.3 THE CT IMAGING SYSTEM

11.3.5 Detectors

□ Quarter detector shift

- By shifting the detector elements by a distance of a quarter of the size of the detector elements, the theoretical achievable spatial resolution becomes twice as good.
- It is generally implemented in detectors of all CT scanners.

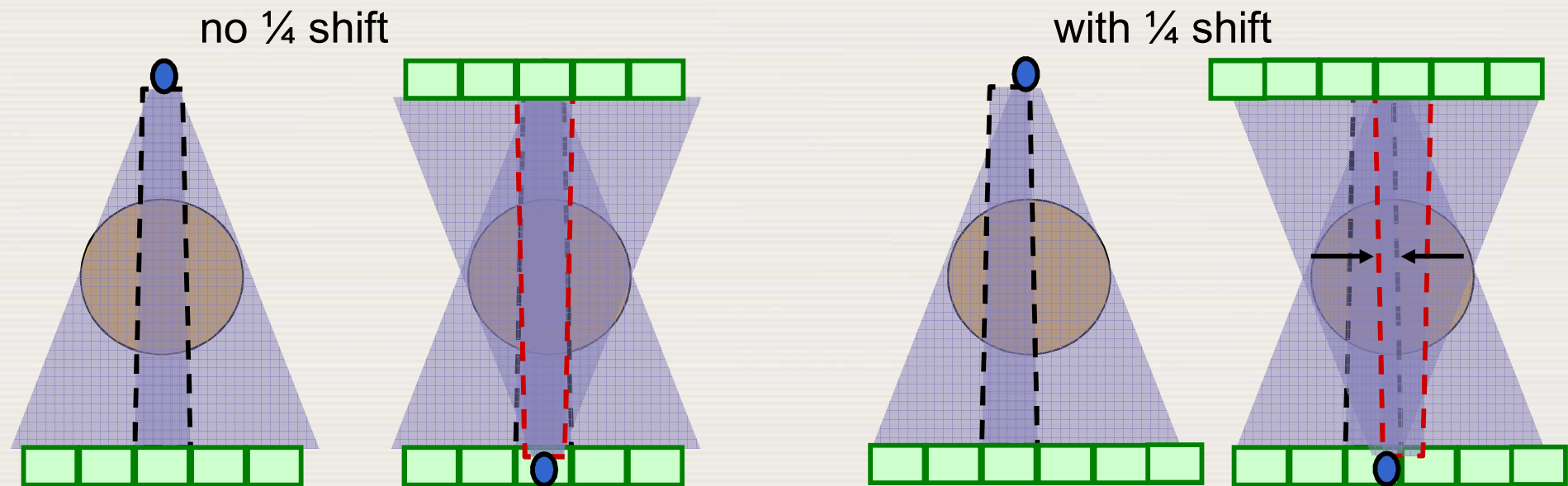

Schematic view of quarter detector shift – X-Y plane

ImPACT

11.3 THE CT IMAGING SYSTEM

11.3.5 Detectors

□ Dynamic or flying focal spot

- Focal spot position on anode is rapidly oscillated during gantry rotation, doubling the number of projections

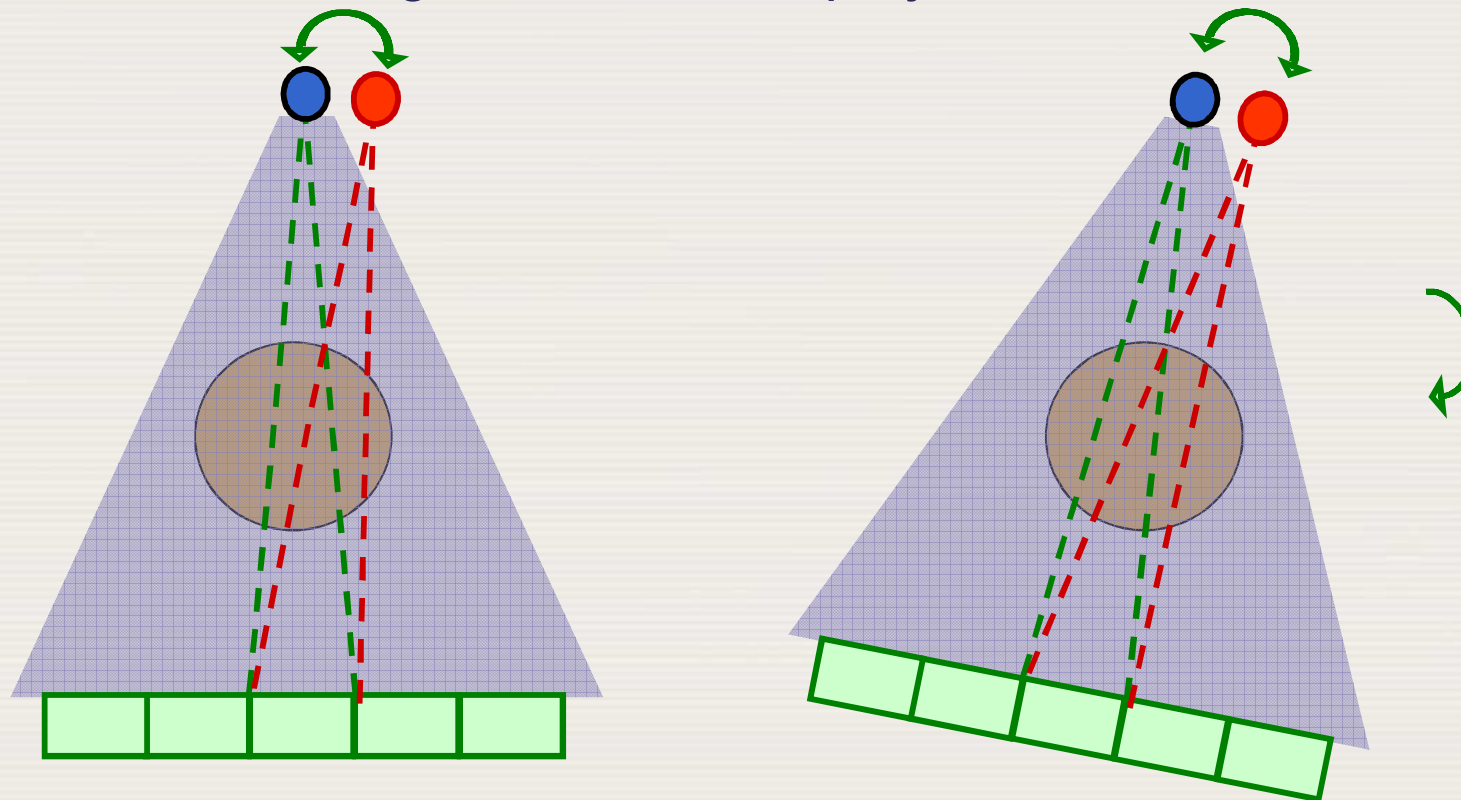

Schematic view of dynamic focal spot – X-Y plane

ImPACT

11.3 THE CT IMAGING SYSTEM

11.3.5 Detectors

- With the current detector rows and/or quarter detector shift and/or flying focal spot a spatial resolution of $\sim 0.6 - 0.9$ mm in the axial plane can be achieved

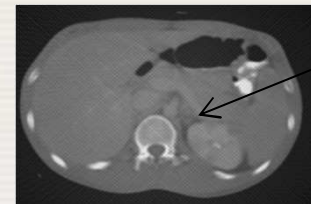
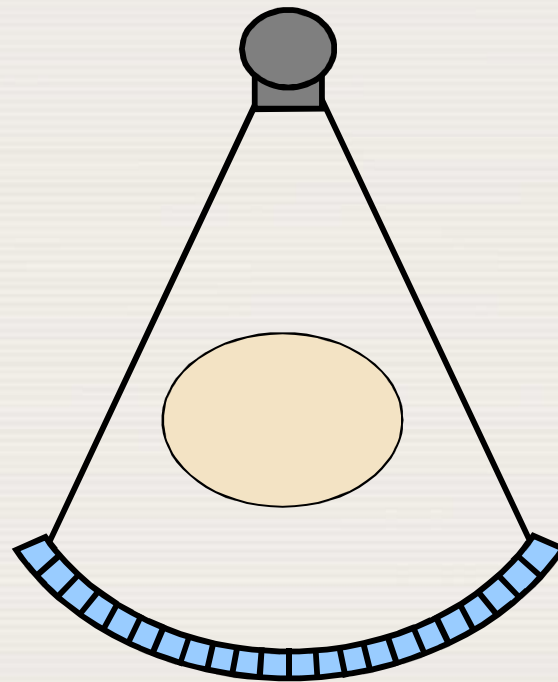

$\sim 0.6 - 0.9$ mm

11.3 THE CT IMAGING SYSTEM

11.3.5 Detectors

- ❑ Along the z-axis multiple detector row scanners give greater coverage along the patient and allows for shorter scan times and thinner reconstructed slices.
- ❑ The number of rows do not necessarily match the number of 'slices of data' – particularly with early multi-slice CT
 - 4 active detector rows - 1998
 - 16 active detector rows - 2001
 - 64 active detector rows in - 2004
 - 320 active detector rows - 2007

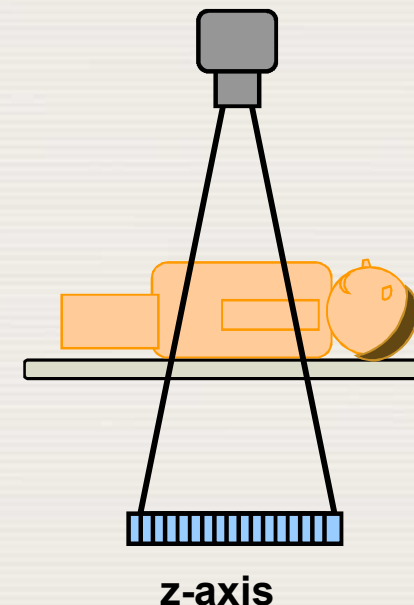

11.3 THE CT IMAGING SYSTEM

11.3.5 Detectors

- Increased coverage of the multi detector row CT scanners increased with more active detector rows

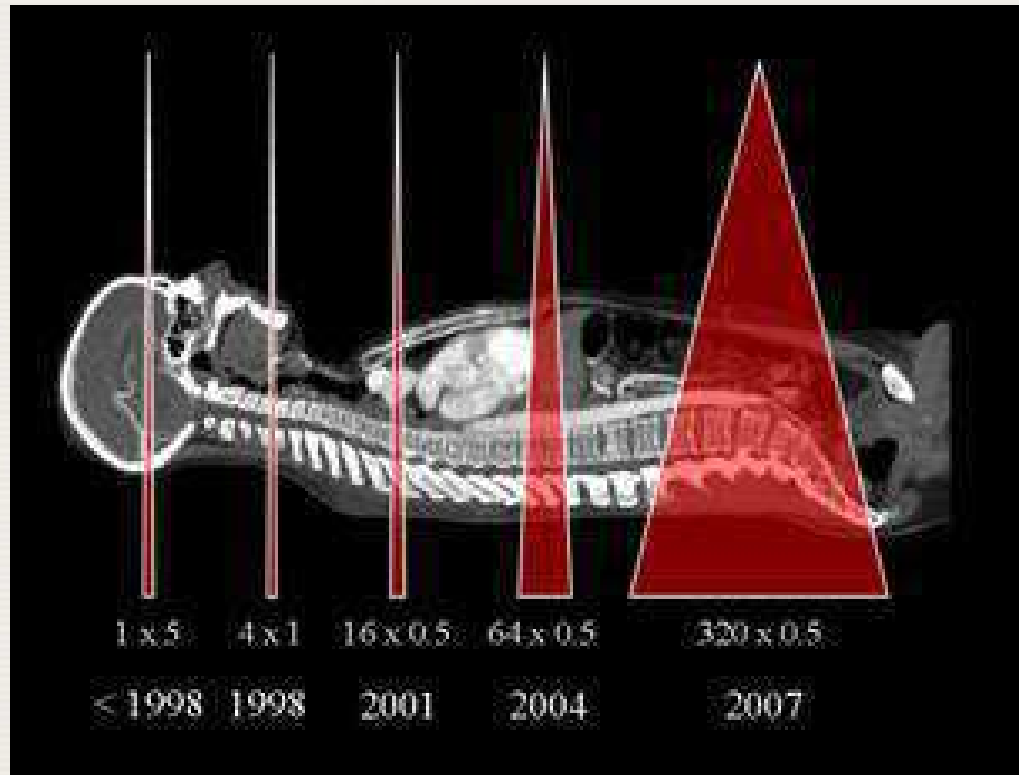

11.3 THE CT IMAGING SYSTEM

11.3.5 Detectors

- A multi-slice scanner may be defined by the number of ‘data slices’ it acquires – or by the number of detector rows
 - e.g. GE LightSpeed, four slice scanner has 16x 1.25 mm detectors
 - it can acquire 4 x 1.25 mm, 4 x 2.5 mm, 4 x 3.75 mm, or 4 x 5 mm slices

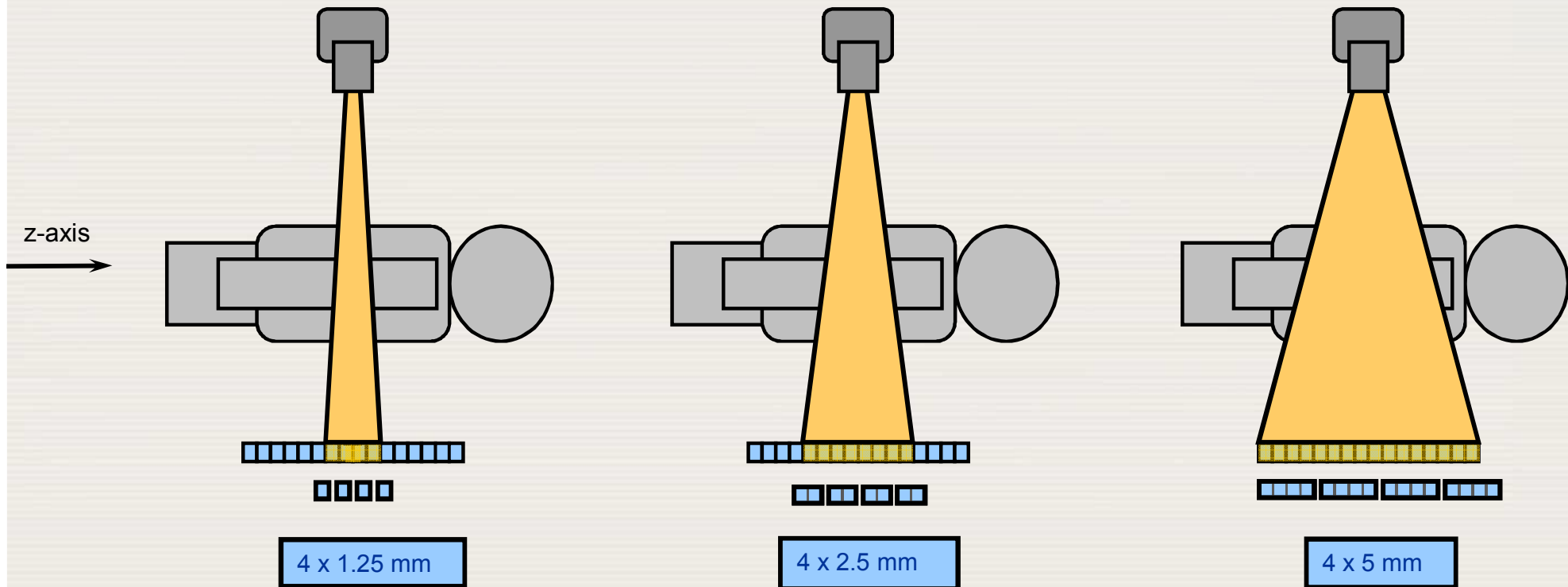

11.3 THE CT IMAGING SYSTEM

11.3.5 Detectors

- ❑ Multi-slice or multi-row scanners enabled
 - Thinner slices
 - Longer scan volumes
 - Faster scan volumes
- ❑ A typical acquisition with a single detector row scanner covered 5 mm.
- ❑ CT scanners with 4 active detector rows achieved a substantial improvement of the longitudinal resolution.
 - For example, by using 4 active detector rows in a 4 x 1 mm acquisition configuration, the longitudinal spatial resolution improved from 5 mm to 1 mm

11.3 THE CT IMAGING SYSTEM

11.3.5 Detectors

- ❑ In clinical practice the CT scanners with 4 active detector rows were primarily used to enhance longitudinal resolution
- ❑ The CT scanners with 4 active detector rows could also be used for enhanced longitudinal coverage, for example by selecting a $4 \times 2 = 8$ mm, or even a $4 \times 4 = 16$ mm coverage.
- ❑ Enhanced longitudinal coverage would allow for shorter scan times but without the benefit of improved longitudinal resolution.

11.3 THE CT IMAGING SYSTEM

11.3.5 Detectors

- ❑ The CT scanners with 16 or 64 active detector rows allowed for acquisitions in for example $16 \times 0.5 = 8$ mm and $64 \times 0.5 = 32$ mm configurations.
 - These scanners provided excellent longitudinal spatial resolution, high quality 3D reconstructions, and at the same time reduced scan times.
- ❑ The CT scanners with up to 64 active detector rows generally cover a scan volume with a helical acquisition with multiple rotations.
- ❑ The 320 detector row CT scanner covers 160 mm on one rotation,
 - for organs such as the brain or the heart within one rotation.

11.4 IMAGE RECONSTRUCTION AND PROCESSING

11.4.1 General concepts

□ Techniques for reconstruction include

- Simple backprojection
- Algebraic reconstruction
- Iterative reconstruction
- Filtered back projection

11.4 IMAGE RECONSTRUCTION AND PROCESSING

11.4.1 General concepts

- During a CT scan, numerous measurements of the transmission of X-rays through a patient are acquired at many angles
- This is the basis for reconstruction of the CT image.

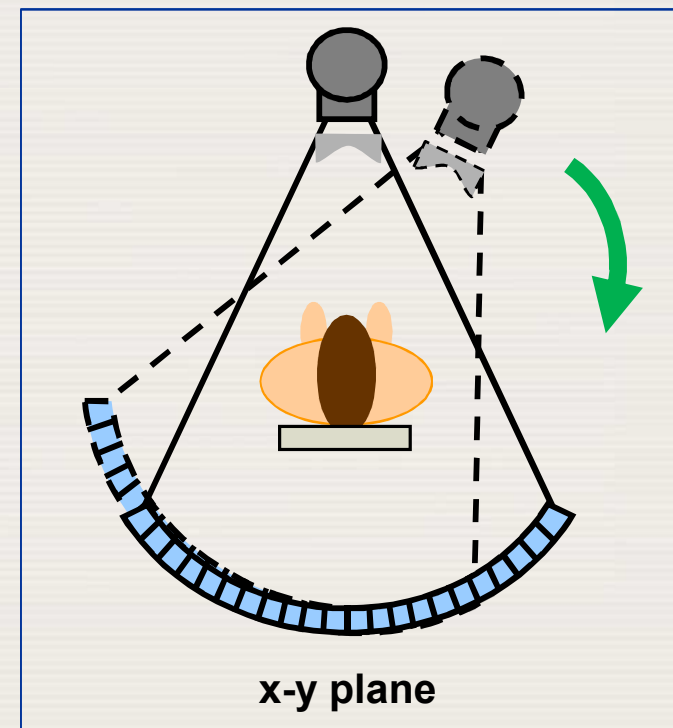
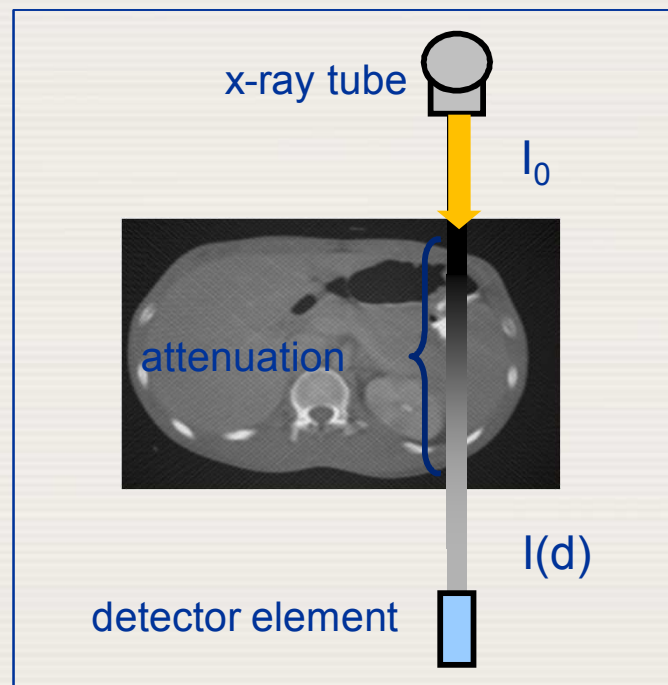

ImPACT

11.4 IMAGE RECONSTRUCTION AND PROCESSING

11.4.1 General concepts

- The logarithm of the (inverse) measured normalized transmission, $\ln(I_0/I(d))$, yields a linear relationship with the products of $\mu_i\Delta x$.

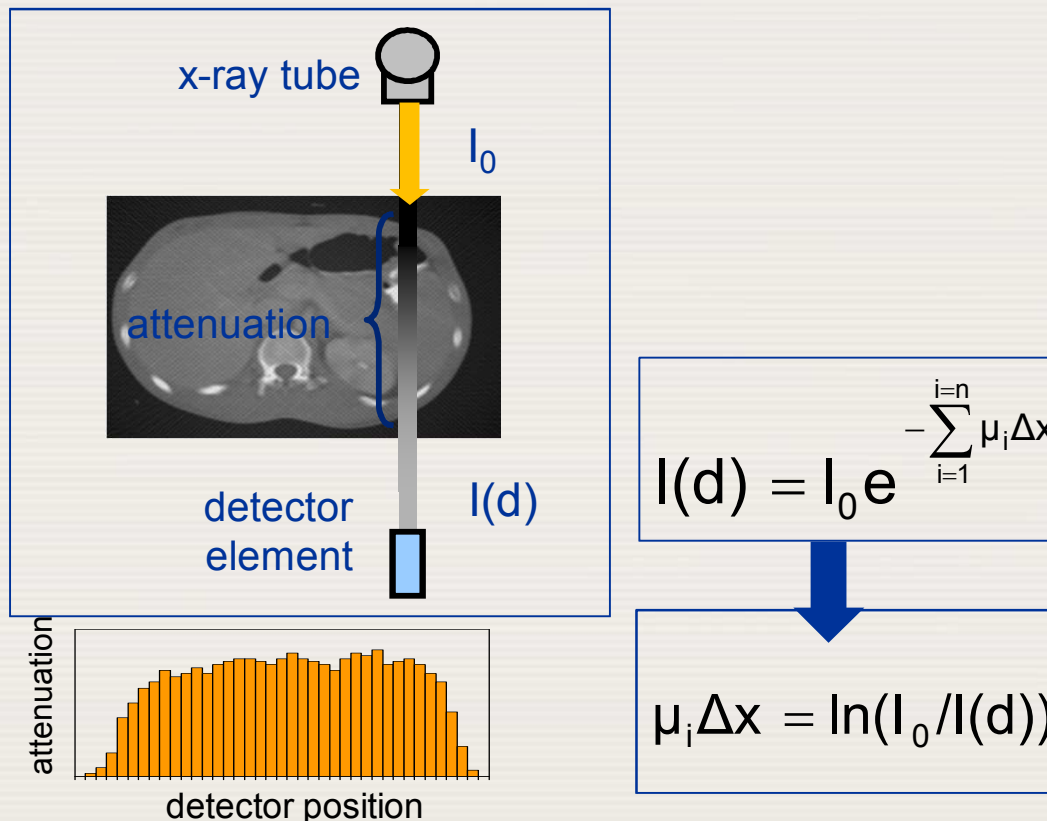

11.4 IMAGE RECONSTRUCTION AND PROCESSING

11.4.1 General concepts

- ❑ The figure below shows
 - (a) the X-ray projection under a certain angle
 - (b) leading to one transmission profile
- ❑ The backprojection distributes the measured signal evenly over the area
 - (c) under the same angle as the projection

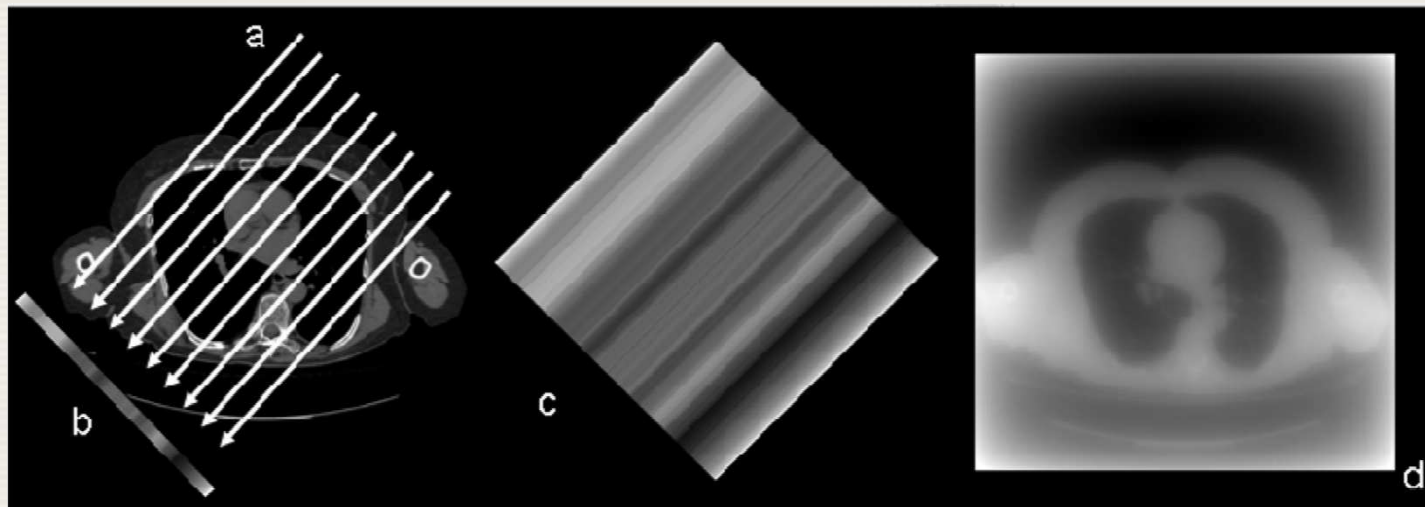

11.4 IMAGE RECONSTRUCTION AND PROCESSING

11.4.1 General concepts

- ❑ **Transmission profiles** are taken from a large number of angles and backprojected
(d) yielding a strongly blurred image
- ❑ Mathematics shows that simple **backprojection** is not sufficient for accurate image reconstruction in CT.
- ❑ Instead a **filtered backprojection** must be used
 - It is the standard for image reconstruction in CT.

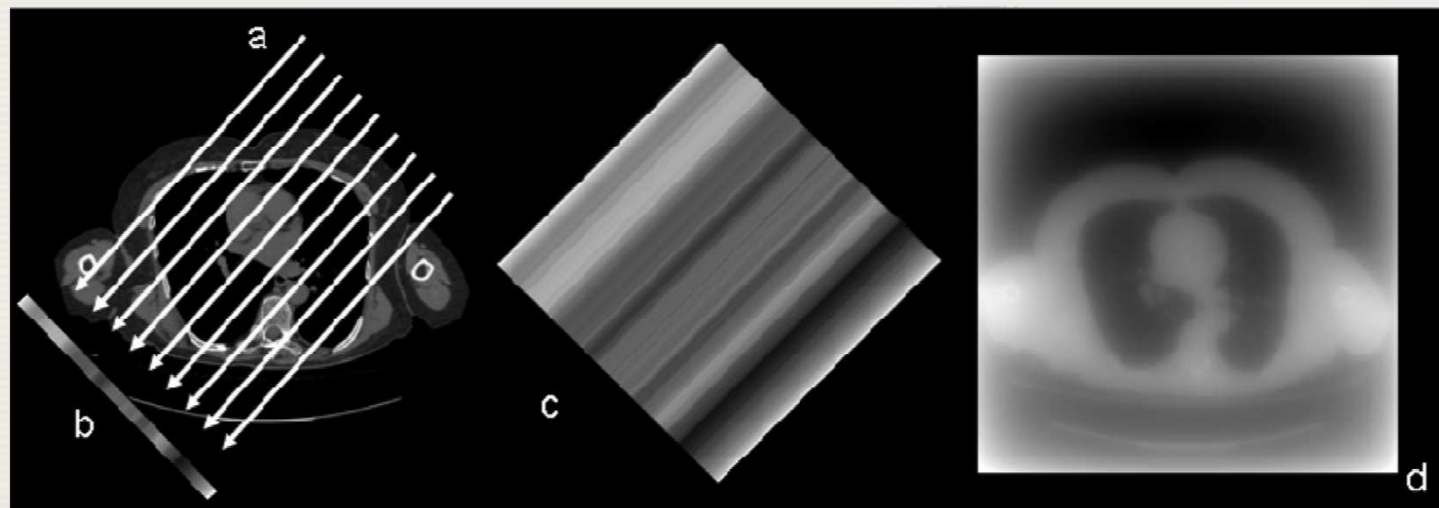

11.4 IMAGE RECONSTRUCTION AND PROCESSING

11.4.1 General concepts

- ❑ Other reconstruction techniques are **algebraic** or **iterative** reconstructions.
- ❑ **Algebraic reconstruction** solves a number of simultaneous equations.
- ❑ For example
 - Projections in two horizontal, two vertical, and two diagonal directions yield six projection values.
 - These values can be used to solve an overcomplete set of six equations.
 - The equations can be solved and they yield the 2 x 2 image matrix.

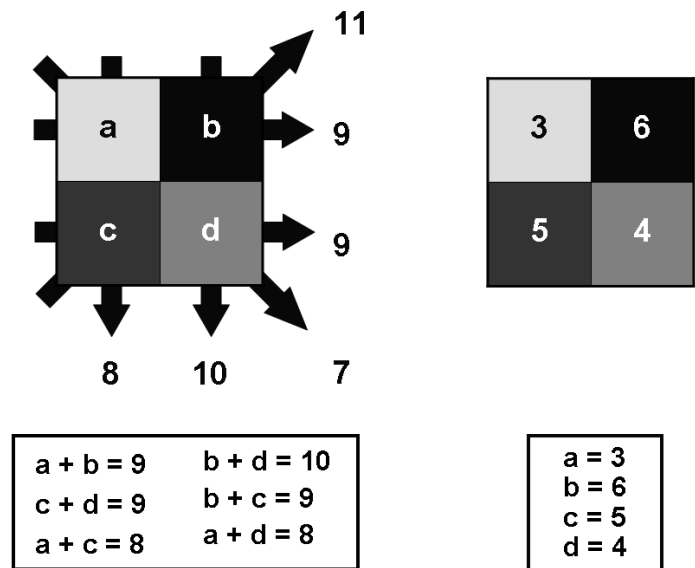

11.4 IMAGE RECONSTRUCTION AND PROCESSING

11.4.1 General concepts

- Algebraic reconstruction in clinical practice is not feasible,
 - due to the large (512 x 512) matrices that are used in medical imaging
 - due to inconsistencies in the equations due to measurement errors and noise.

11.4 IMAGE RECONSTRUCTION AND PROCESSING

11.4.1 General concepts

- ❑ **Iterative (statistical) reconstructions** are sometimes used
 - These are routinely used in nuclear medicine.
 - They are becoming available for commercial CT scanners
- ❑ **Potential benefits** of iterative reconstructions
 - the removal of **streak artefacts** (particularly when fewer projection angles are used)
 - better performance in **low-dose CT acquisitions**
- ❑ However, images may be affected by other artefacts
 - aliasing patterns
 - overshoot in the areas of sharp intensity transitions

11.4 IMAGE RECONSTRUCTION AND PROCESSING

11.4.2 Object, image and radon space

- ❑ **Filtered backprojection** is the most frequently applied technique for CT reconstruction
- ❑ To understand this it is essential to introduce three interrelated domains:
 - **Object space, Radon space, Fourier space.**
- ❑ The three spatial domains are **interrelated**, and their relationships can be described mathematically.

11.4 IMAGE RECONSTRUCTION AND PROCESSING

11.4.2 Object, image and radon space

- The **three domains** associated with the technique of filtered backprojection are
- Object** space (linear attenuation values),
 - Radon** space (projection values recorded under many angles)
 - this domain is also referred to as sinogram space where Cartesian coordinates are used),
 - Fourier** space
 - which can be derived from object space by a 2D Fourier transform.

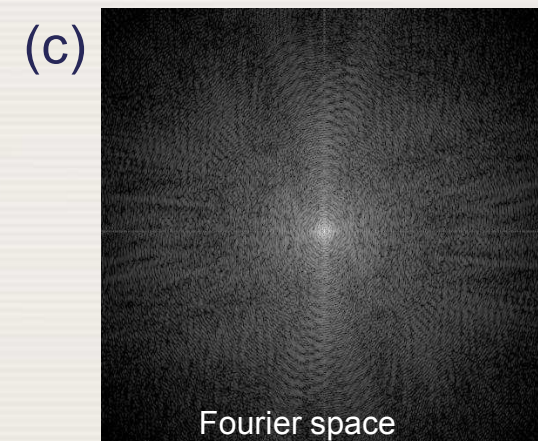
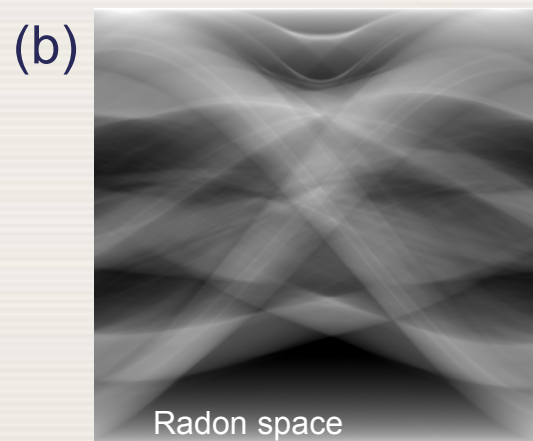
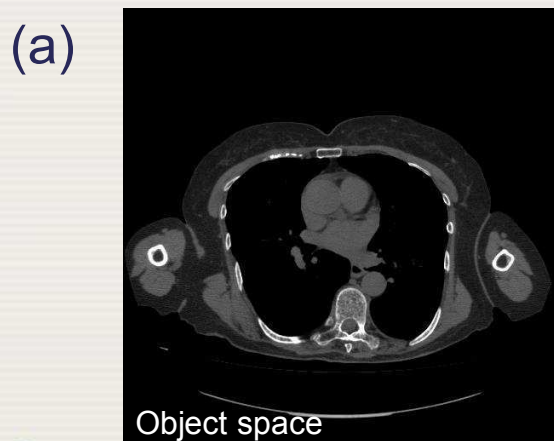

11.4 IMAGE RECONSTRUCTION AND PROCESSING

11.4.2 Object, image and radon space

□ The figure below illustrates the interrelations between the three domains for one projection angle.

(a) One specific projection angle in **object space**

(b) The projection that is recorded by the CT scanner

(c) This projection corresponds with one line in **Radon space**

(d) One angulated line in **Fourier space** is created from a 1-D transform of the recorded line in the **sinogram**

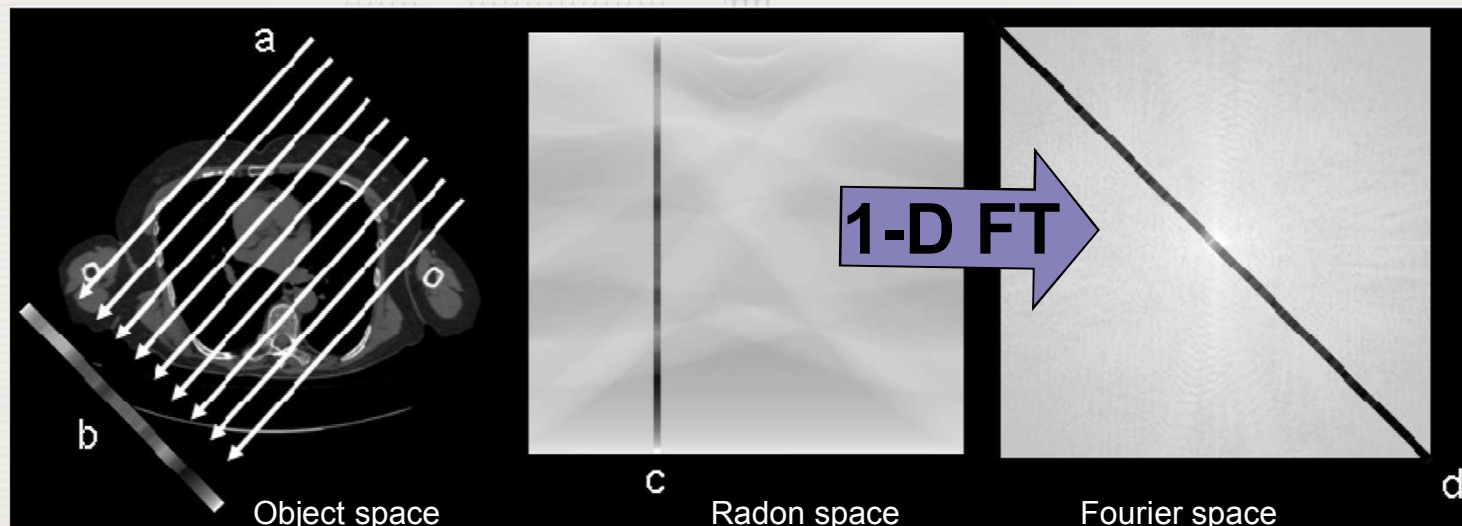

11.4 IMAGE RECONSTRUCTION AND PROCESSING

11.4.2 Object, image and radon space

- The Fourier slice theorem states that the 1D Fourier transform of the projection profile yields an angulated line in (Cartesian) Fourier space at the angle of the projection.

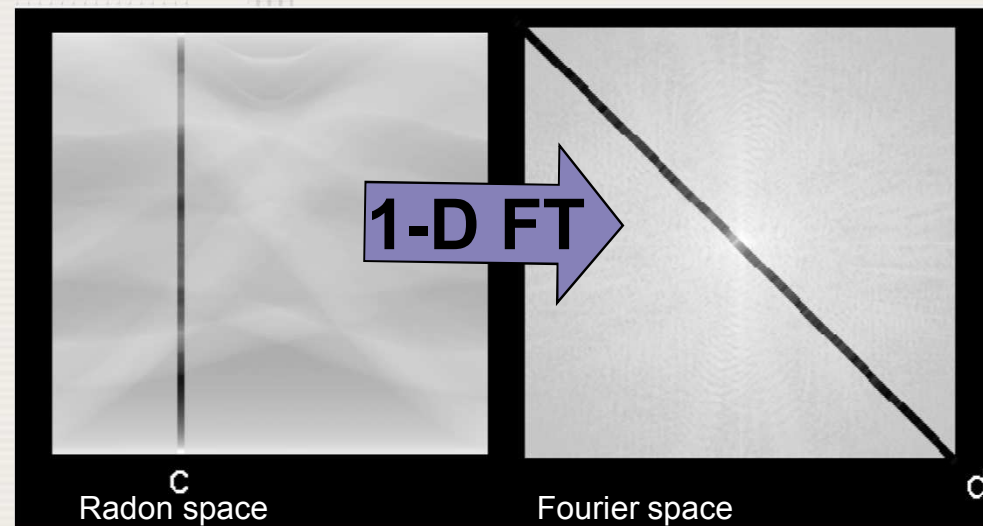

Reference - A. C. Kak and M. Slaney (Principles of Computerized Tomographic Imaging, IEEE Press, 1988, <http://www.slaney.org/pct>).

11.4 IMAGE RECONSTRUCTION AND PROCESSING

11.4.2 Object, image and radon space

- The interrelationships between the three domains
 - object space, Radon space, and Fourier space

A 2D Radon transform converts the object space into Radon space.

The creation of 2D Radon space is carried out during a CT scan: projections are recorded and they are stored as raw data in 2D Radon space.

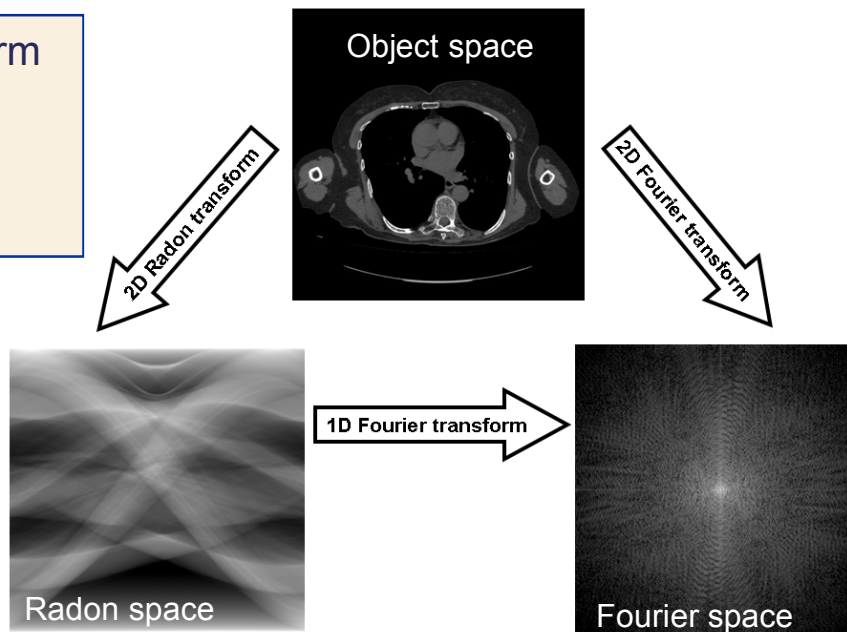

- According to the central slice theorem, many 1D Fourier transforms of transmission profiles under many angles allow for creating the Fourier space of the object space.
- The number of 1D transforms is equal to the number of registered profiles

11.4 IMAGE RECONSTRUCTION AND PROCESSING

11.4.2 Object, image and radon space

- It might be expected that an inverse 2D Fourier transform of Fourier space would be used in CT to reconstruct the object space
 - However, this does not yield the best result.

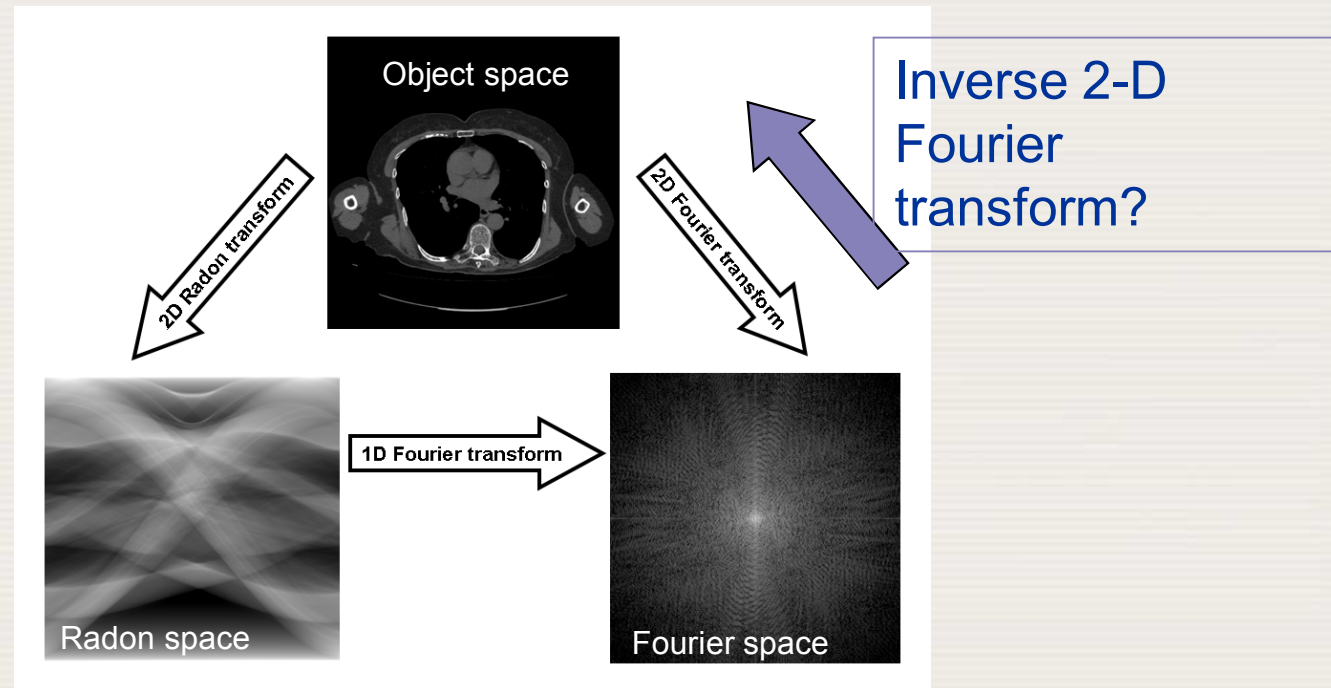

11.4 IMAGE RECONSTRUCTION AND PROCESSING

11.4.2 Object, image and radon space

- ❑ The re-binning of the Fourier transformed angulated projections, and the associated interpolations, that are required to achieve a Fourier space in Cartesian coordinates is prone to induce artefacts in the reconstructed images.
- ❑ A better technique for CT reconstruction is to use a filtered backprojection.

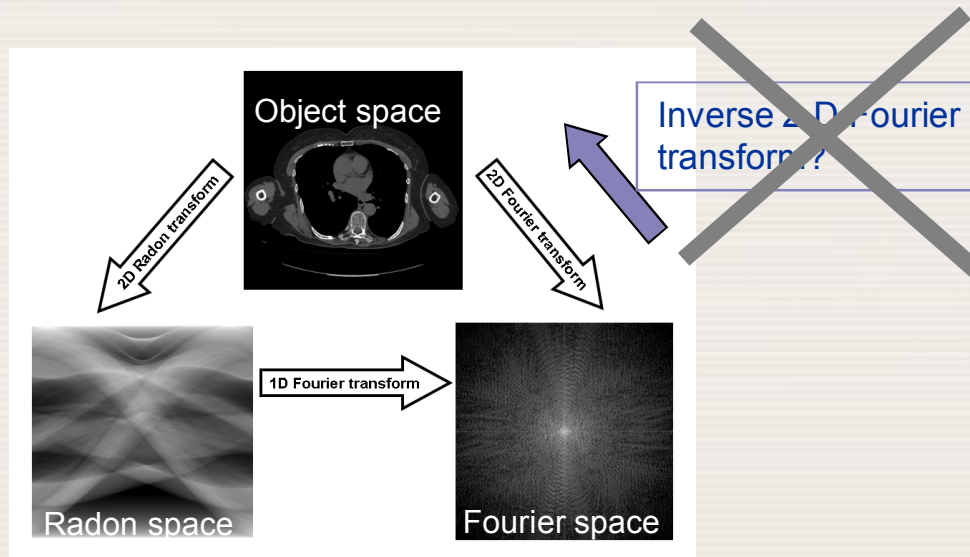

11.4 IMAGE RECONSTRUCTION AND PROCESSING

11.4.3 Filtered back projection and other reconstructions

- The mathematical operations that are required for a filtered backprojection consist of four steps.
 1. A **Fourier transform** of **Radon space** should be performed (requiring many 1D Fourier transforms).
 2. Then a **high-pass filter** should be applied to each one of the **1D Fourier transforms**.

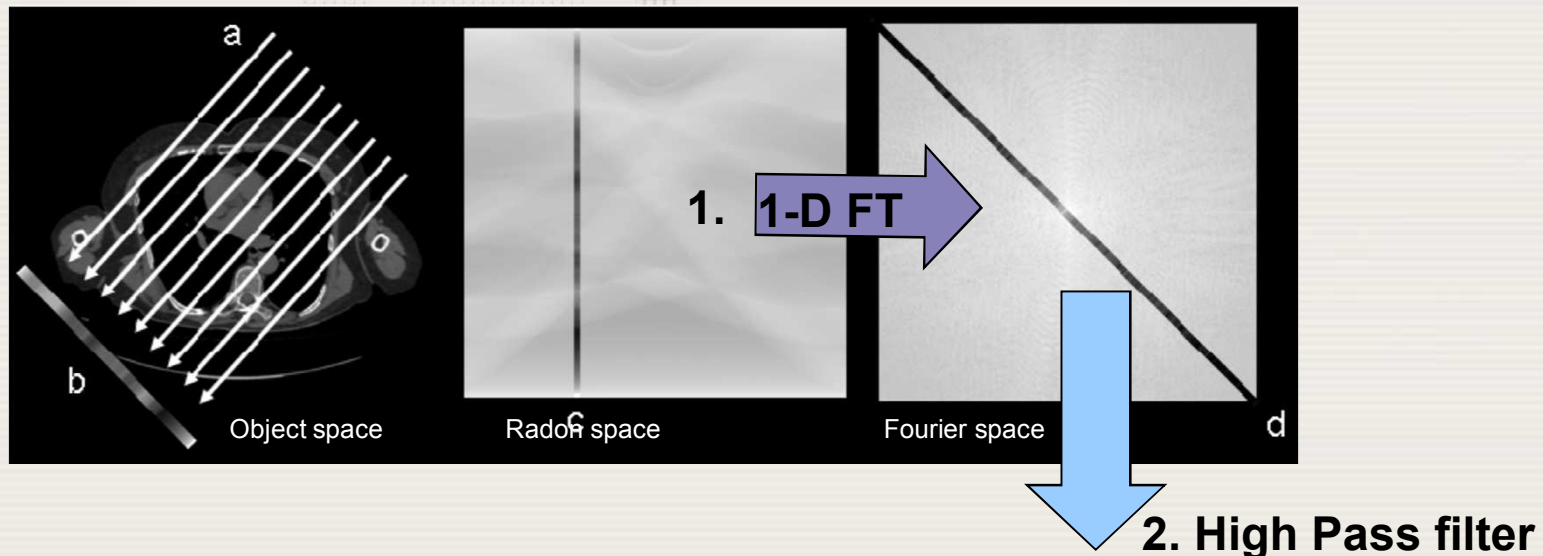

11.4 IMAGE RECONSTRUCTION AND PROCESSING

11.4.3 Filtered back projection and other reconstructions

- The mathematical operations that are required for a filtered backprojection consist of four steps.
 3. Next an **inverse Fourier transform** should be applied to the **high pass filtered Fourier transforms** in order to obtain a **Radon space** with modified projection profiles.
 4. Subsequently, **backprojection** of the **filtered profiles** yields the reconstruction of the measured object.

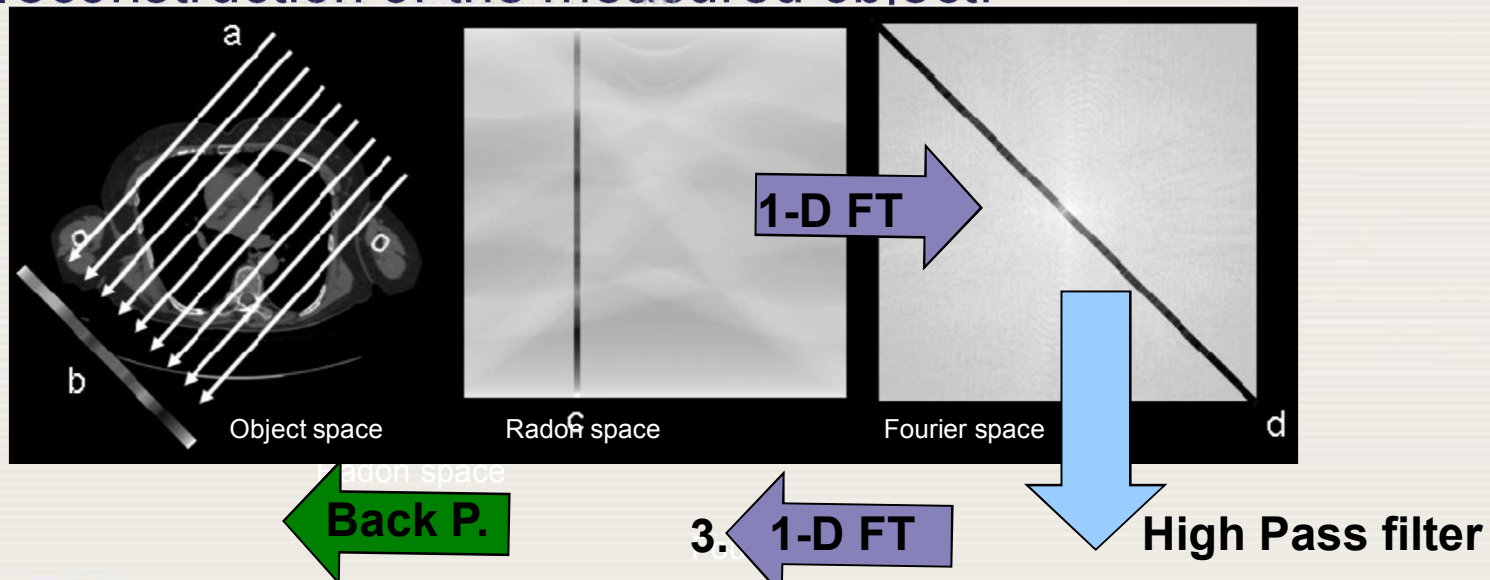

11.4 IMAGE RECONSTRUCTION AND PROCESSING

11.4.3 Filtered back projection and other reconstructions

- Mathematics also shows that the high pass filter that is applied to the Fourier domain can be substituted by a convolution of profiles with an appropriate kernel directly in the Radon domain.

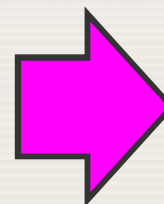
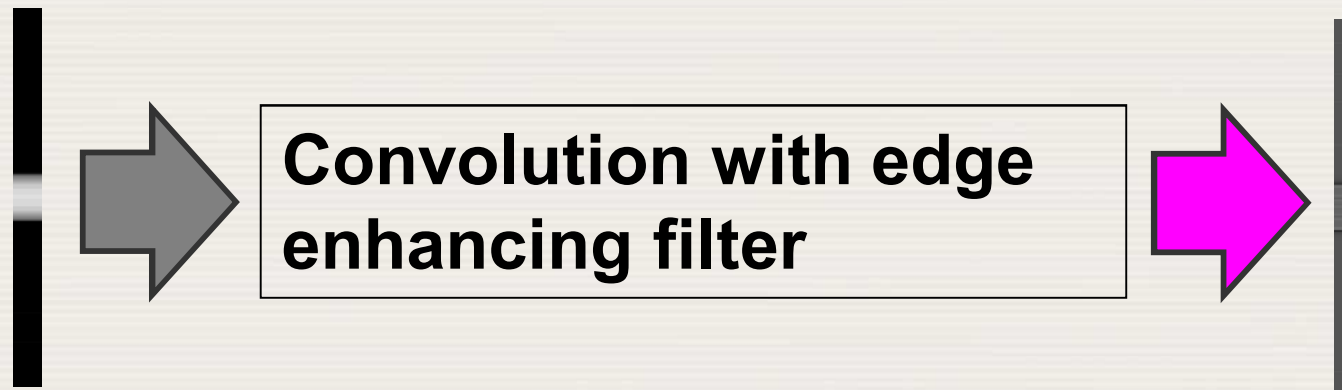

11.4 IMAGE RECONSTRUCTION AND PROCESSING

11.4.3 Filtered back projection and other reconstructions

- ❑ Successive filtered backprojections with
 - 1, 2, 4, 8, 16, 32, 64, 256, and 1024 backprojections
- ❑ This shows how successive filtered backprojections under different angles can be used to achieve a good reconstruction of the space domain

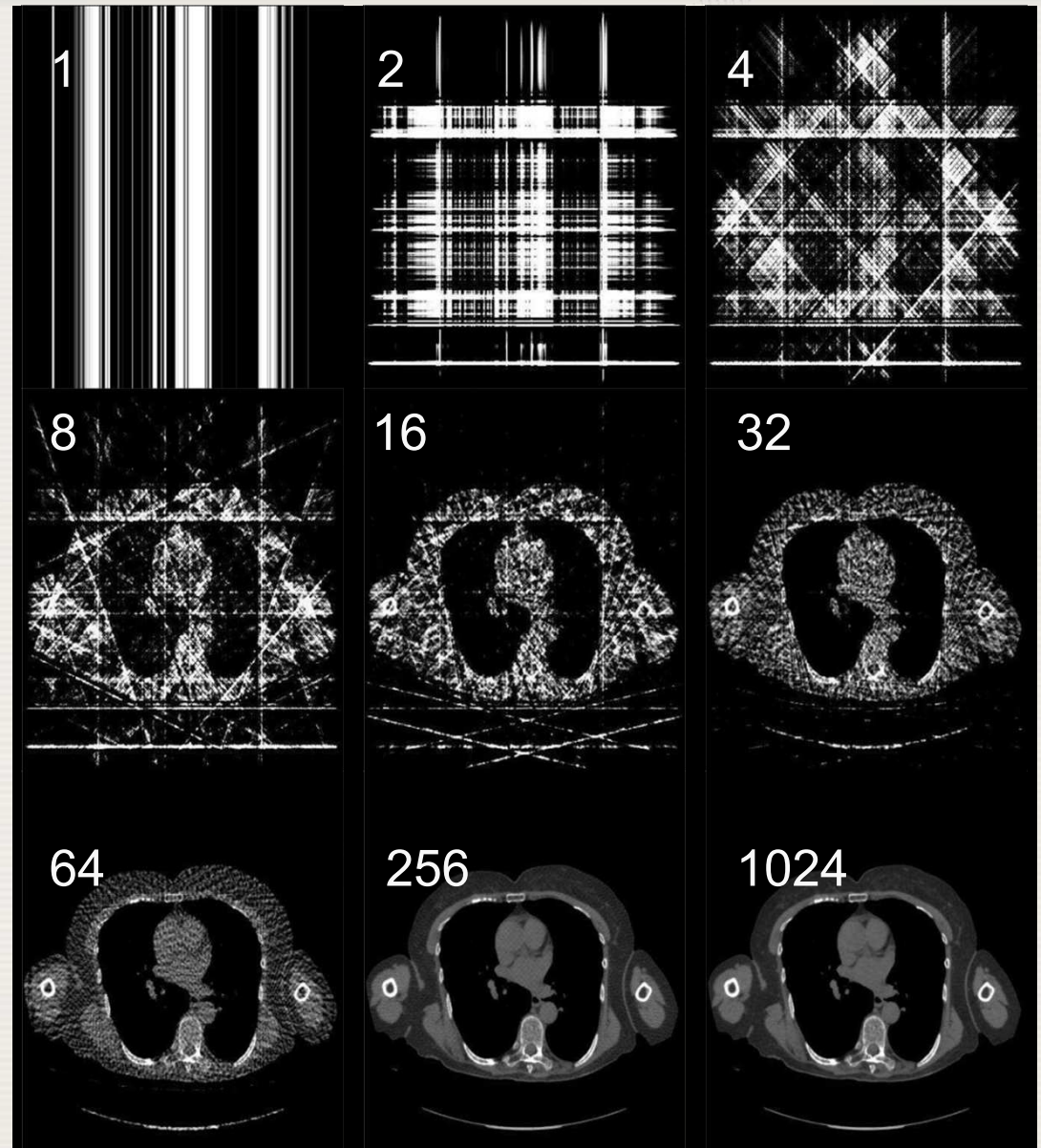

11.4 IMAGE RECONSTRUCTION AND PROCESSING

11.4.3 Filtered back projection and other reconstructions

- ❑ Image space is generally represented on a regular grid
 - The 2D image space is defined as $f(x,y)$, where (x,y) are the Cartesian coordinates in image space.
- ❑ One 1D projection of the 2D image space with equidistant and parallel rays yields one line in Radon space
 - expressed as the projection $p(t,\theta)$, where t is the distance from the projected x-ray to the iso-center and θ is the projection angle

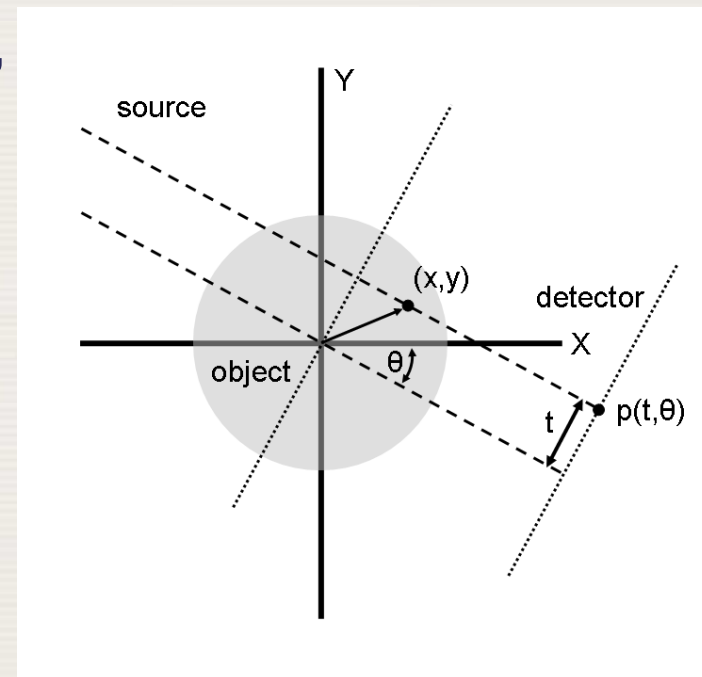

11.4 IMAGE RECONSTRUCTION AND PROCESSING

11.4.3 Filtered back projection and other reconstructions

- The central slice theorem (the Fourier slice theorem)
 - the Fourier transform of such a parallel projection of image space at the projection angle θ yields one line in 2D Fourier space $F(u,v)$, angulated at the same angle θ (the 2D Fourier space is sometimes also referred to as k-space).
- At the projection angle $\theta = 0$ the projection $p(x,0)$, and the corresponding line in Radon space, is described as:

$$p(x,0) = \int_{-\infty}^{+\infty} f(x,y)dy$$

11.4 IMAGE RECONSTRUCTION AND PROCESSING

11.4.3 Filtered back projection and other reconstructions

- The 1D Fourier transform with respect to x of the projection $p(x,0)$ at the projection angle $\theta = 0$ is described by:

$$P(u) = \int_{-\infty}^{+\infty} p(x,0)e^{-i2\pi ux} dx = \int_{-\infty}^{+\infty} \int_{-\infty}^{+\infty} f(x,y)e^{-i2\pi ux} dx dy$$

- The 2D Fourier transform $F(u,v)$ of the 2D image space $f(x,y)$ at $v = 0$ yields:

$$F(u,v)|_{v=0} = \int_{-\infty}^{+\infty} \int_{-\infty}^{+\infty} f(x,y)e^{-i2\pi(ux+vy)} dx dy|_{v=0} = \int_{-\infty}^{+\infty} \int_{-\infty}^{+\infty} f(x,y)e^{-i2\pi ux} dx dy$$

11.4 IMAGE RECONSTRUCTION AND PROCESSING

11.4.3 Filtered back projection and other reconstructions

- It thus becomes clear that the 1D Fourier transform with respect to x for the projection angle $\theta = 0$ equals the 2D Fourier transform $F(u,v)$ of the 2D image space $f(x,y)$ at $v = 0$:

$$P(u) = F(u, v)|_{v=0}$$

11.4 IMAGE RECONSTRUCTION AND PROCESSING

11.4.3 Filtered back projection and other reconstructions

- This conclusion can be generalized for any projection angle θ and it thus provides the proof for the central slice theorem
- A reconstruction can thus, at least theoretically, be achieved by first a construction of the 2D Fourier space $F(u,v)$ by many **1D Fourier transforms** of the projection profiles measured under many projection angles, and subsequently a **2D inverse Fourier transform** of the **2D Fourier space** to the **2D image space**.
- The sampling of the **2D Fourier space** from the **1D Fourier transforms** of the projections yields a **2D Fourier space** in regular polar coordinates.

11.4 IMAGE RECONSTRUCTION AND PROCESSING

11.4.3 Filtered back projection and other reconstructions

- ❑ Prior to the **2D inverse Fourier transform** into image space, the regular distributed points in the **polar 2D Fourier space** have to be transformed in regular distributed point is a **Cartesian 2D Fourier space**.
- ❑ The transformation from a **polar coordinate system** to a **Cartesian coordinate system** may lead to artifacts in the reconstructed image
- ❑ Note that the **sampling** of the **2D Fourier space** is denser around the origin (**low frequencies**), and sparser further away from the origin (**high frequencies**)

11.4 IMAGE RECONSTRUCTION AND PROCESSING

11.4.3 Filtered back projection and other reconstructions

- The CT scan yields a regular distributed sampling in polar coordinates of **2D Fourier space**. Transformation into a regular distributed sampling in **Cartesian coordinates** is complicated, particularly at higher frequencies (further from the origin).

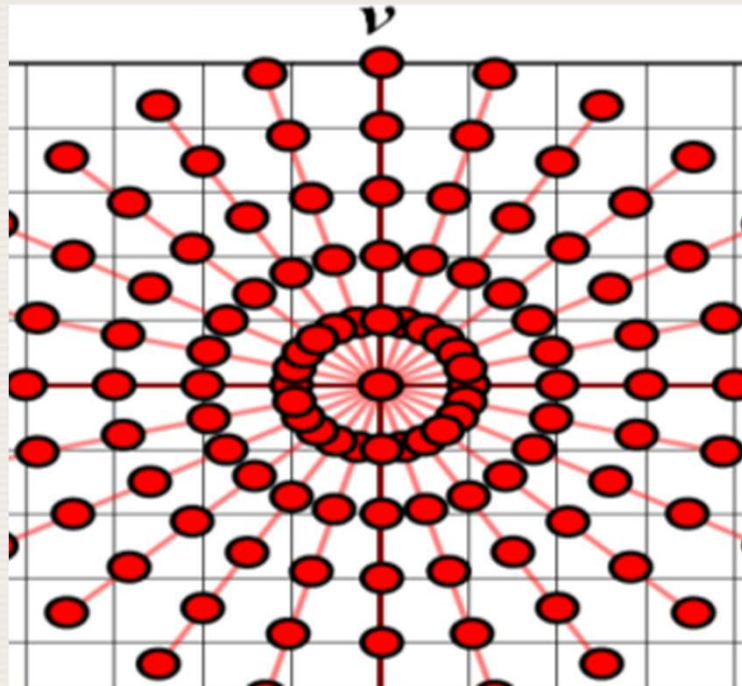

11.4 IMAGE RECONSTRUCTION AND PROCESSING

11.4.3 Filtered back projection and other reconstructions

- ❑ A more accurate and practical reconstruction can be achieved with the **filtered backprojection**
- ❑ This also starts with **1D Fourier transforms** of image space, thus creating the corresponding **Fourier space**.
- ❑ The sampling of the 2D Fourier space $F(u,v)$ can be expressed more conveniently in a **polar grid**, the corresponding coordinate transform is:

$$u = \omega \cos \theta \quad v = \omega \sin \theta$$

11.4 IMAGE RECONSTRUCTION AND PROCESSING

11.4.3 Filtered back projection and other reconstructions

- The filtered backprojection can be expressed as:

$$f(x, y) = \int_0^\pi d\theta \int_{-\infty}^{+\infty} P(\omega(\theta)) |\omega| e^{i2\pi\omega(x\cos\theta + y\sin\theta)} d\omega$$

- where $P(\omega, \theta)$ is the 1D Fourier transform of the 1D projection at angle θ , and $|\omega|$ represents the ramp filter in the frequency domain.

11.4 IMAGE RECONSTRUCTION AND PROCESSING

11.4.3 Filtered back projection and other reconstructions

- The filter (or convolution kernel) in a filtered backprojection that theoretically yields an optimal reconstruction is the so-called **Ramachandran-Lakshminarayanan (Ram-Lak)** filter, also a **ramp** filter.
 - It provides optimal spatial resolution in the reconstructed images.
 - It also yields relatively high noise levels
- Such a theoretically ‘optimal’ filter is in clinical practice referred to as a **sharp or bone filter**.

11.4 IMAGE RECONSTRUCTION AND PROCESSING

11.4.3 Filtered back projection and other reconstructions

- ❑ Often filters are used that reduce the noise level in the reconstructed images, these filters provide some roll-off at higher frequencies
- ❑ A **modest roll-off** is achieved with the **Shepp-Logan filter**, it provides images that are
 - less noisy, provide better low contrast resolution and
 - slightly worse spatial resolution in the reconstructed images
 - Such filters are referred to as normal filters.
- ❑ A **stronger roll-off at higher frequencies** leads
 - to even more noise reduction, better low contrast resolution,
 - but noticeable worse spatial resolution
 - Such filters are in clinical applications referred to as soft tissue filters.

11.4 IMAGE RECONSTRUCTION AND PROCESSING

11.4.3 Filtered back projection and other reconstructions

- CT scanners offer many reconstruction filters that are optimized for specific clinical purposes. It is possible to reconstruct one single CT scan with different reconstruction filters in order to optimize the visualization of for example both bone and soft tissue adequately.

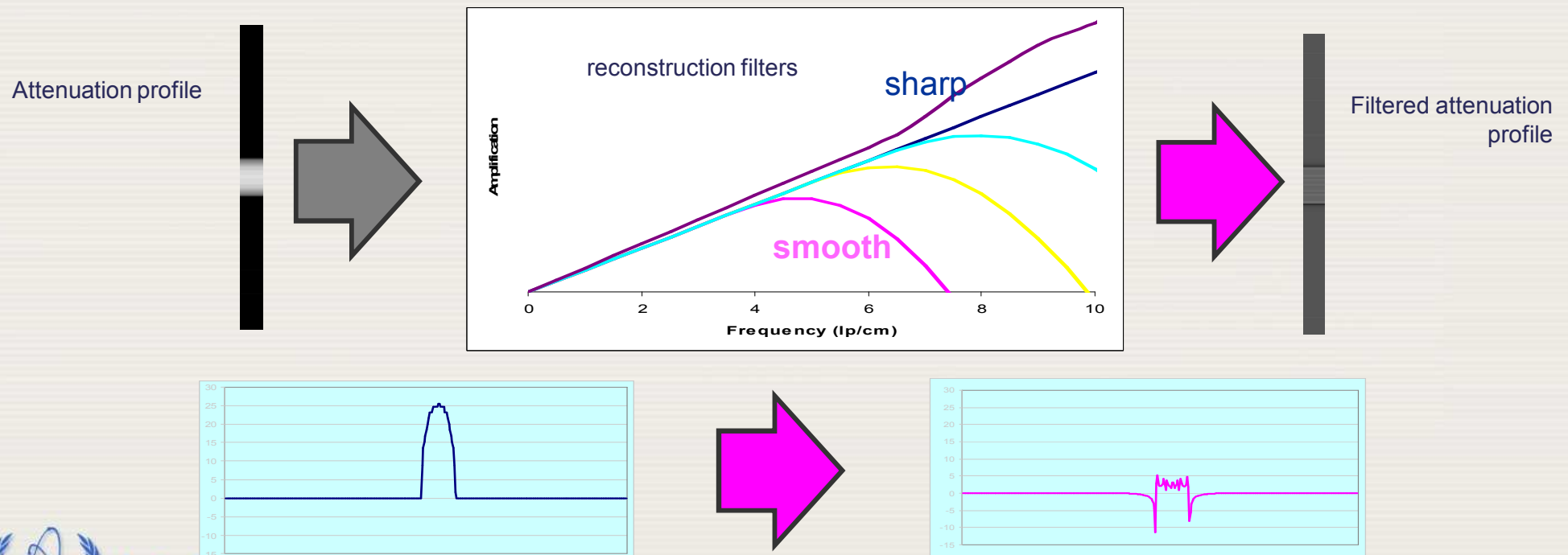

11.5 ACQUISITION

11.5.1 Scan projection radiograph

- ❑ The actual **CT scan** is generally preceded by a **2D scan projection radiograph (SPR)** to assist in planning the scan
- ❑ The **SPR** is acquired with a stationary (non-rotating) X-ray tube, a narrowly collimated fan beam and a moving table.
- ❑ The X-ray tube is fixed, generally in a position that yields either a frontal or lateral **SPR** of the patient.
- ❑ Either one (frontal or lateral view) or two (frontal and lateral view) **SPRs** are acquired prior to the CT scan.

11.5 ACQUISITION

11.5.1 Scan projection radiograph

□ Illustration of the scan projection radiograph (SPR)

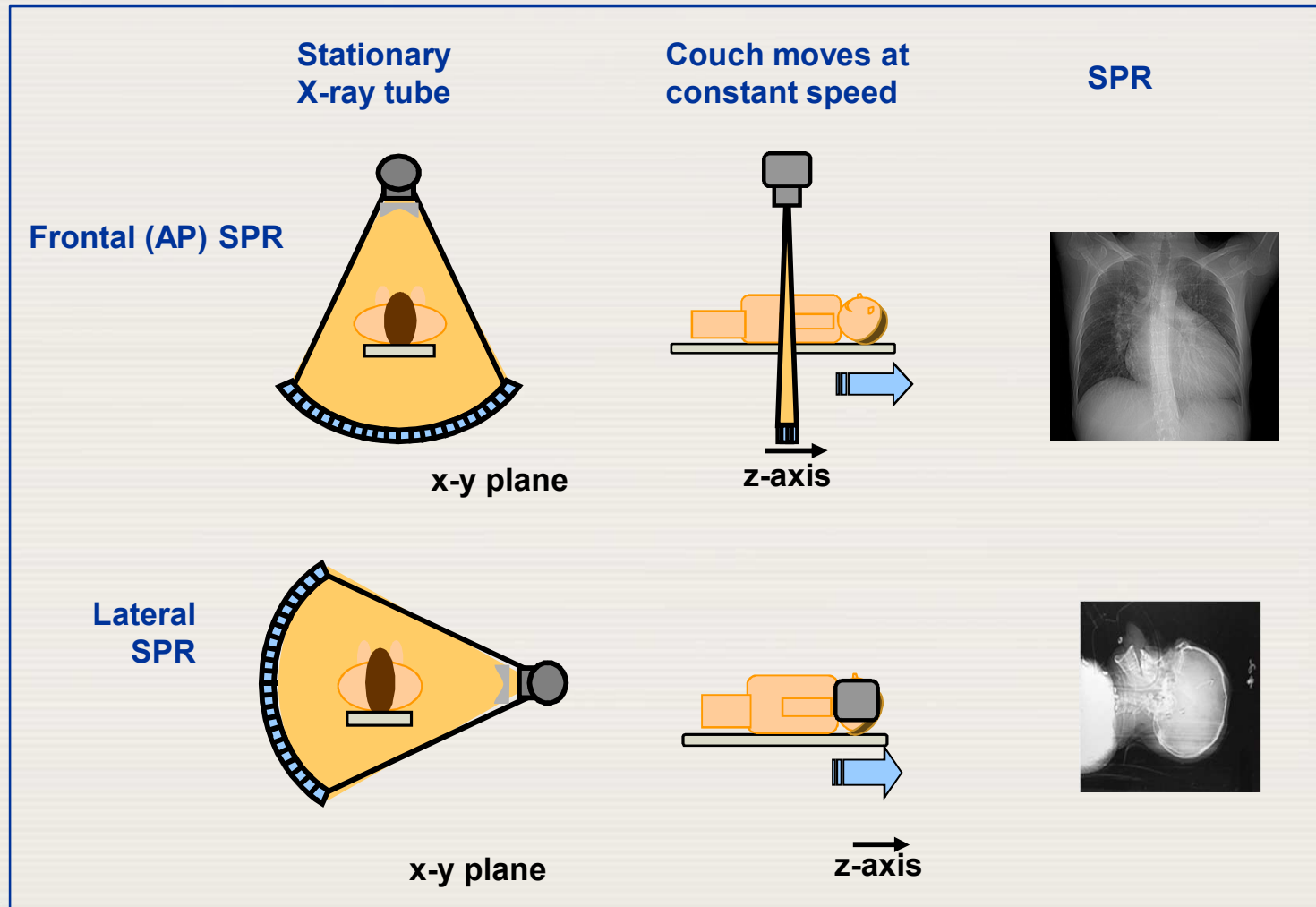

11.5 ACQUISITION

11.5.1 Scan projection radiograph

- ❑ The start position of the **scan projection radiograph (SPR)** is determined by the CT technician during the positioning of the patient on the table prior to the CT scan, this is achieved with the aid of laser positioning lights that are mounted within the gantry.
- ❑ The extend of **SPR** is generally predefined for specific CT acquisition protocols and can be adapted for individual patients by the CT technician.

11.5 ACQUISITION

11.5.1 Scan projection radiograph

- ❑ The **SPR** is performed at intermediate tube voltage (120 kV) and a low tube current (50 -100 mA).
- ❑ The associated radiation exposure for the patient is low, and negligible compared to the radiation exposure from the CT scan.
- ❑ The image quality, particularly the spatial resolution, of CT survey radiographs is modest compared to clinical radiographs.

11.5 ACQUISITION

11.5.1 Scan projection radiograph

- ❑ The **SPRs** are used for planning the start and end position of the CT acquisition
- ❑ The technician selects from the SPR the optimal scan range for the actual CT scan. Also the field of view (marked in yellow), and gantry angle of scan (brain).



SPR Brain

SPR chest

SPR lumbar spine

11.5 ACQUISITION

11.5.1 Scan projection radiograph

- Example: Z-axis modulation
 - Adaptation of the tube current (mAs) is only shown at four levels
 - However during the helical acquisition the tube current continuously optimized at each level within the scanned range
- The tube current is increased in areas with high attenuation and decreased in areas with low attenuation of X-rays.

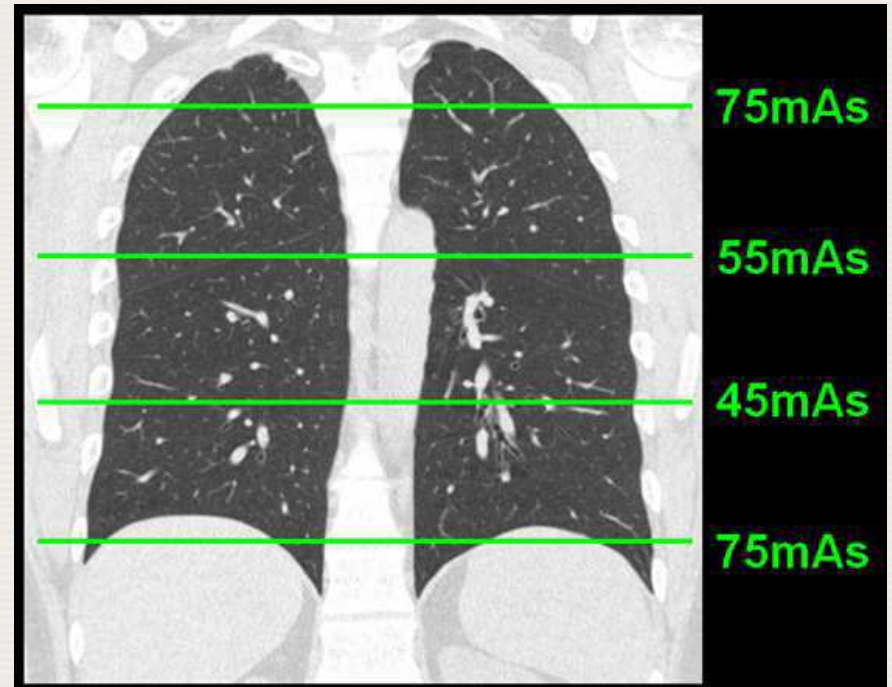

11.5 ACQUISITION

11.5.2 Axial CT scan

- ❑ An axial CT scan involves an acquisition of transmission profiles with a rotating X-ray tube and a static table.
- ❑ An axial acquisition is generally performed with one full 360° rotation of the X-ray tube, but to enhance temporal resolution, this may be reduced to a shorter “ $180^\circ + \text{fan angle}$ ” acquisition.
- ❑ The rotation angle can be extended to for example a 720° acquisition to enhance low contrast resolution by allowing a higher tube current (mAs).
- ❑ A complete CT scan involves generally subsequent and contiguous axial acquisitions in order to cover a clinically relevant volume.

11.5 ACQUISITION

11.5.2 Axial CT scan

- The complete examination is achieved by translation of the table (“step”) after each axial acquisition (“shoot”)
 - this is referred to as a step and shoot acquisition, sequential or axial scanning
 - Usually, the table translation is equal to the slice thickness so that subsequent axial acquisitions can be reconstructed as contiguous axial images.

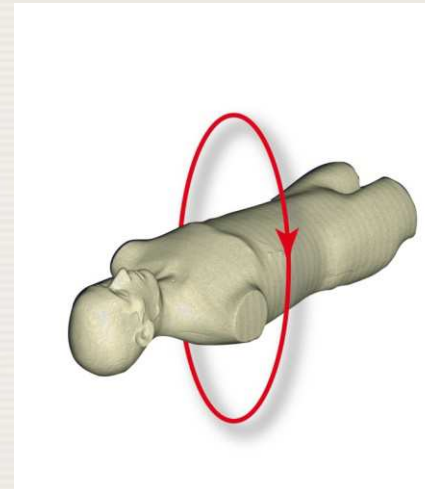
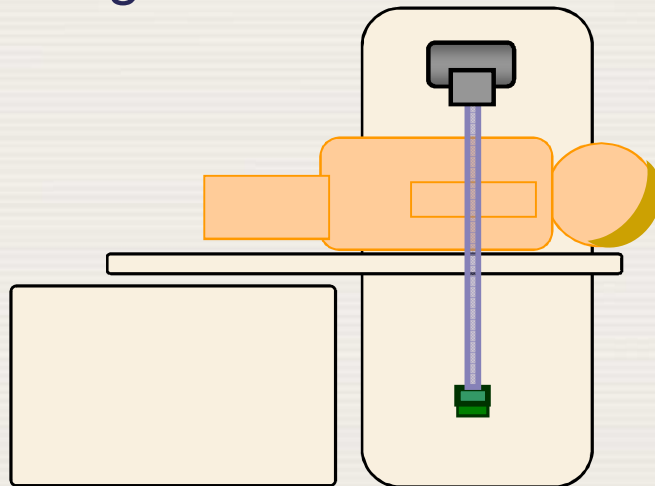

11.5 ACQUISITION

11.5.3 Helical CT scan

- ❑ On early scanners only axial CT scans could be made.
- ❑ In 1989 the CT acquisition with a rotating x ray tube was combined with a moving table.
 - This was called helical or spiral scanning – from the perspective of a patient the circular trajectory of the X-ray tube, becomes, a helical path

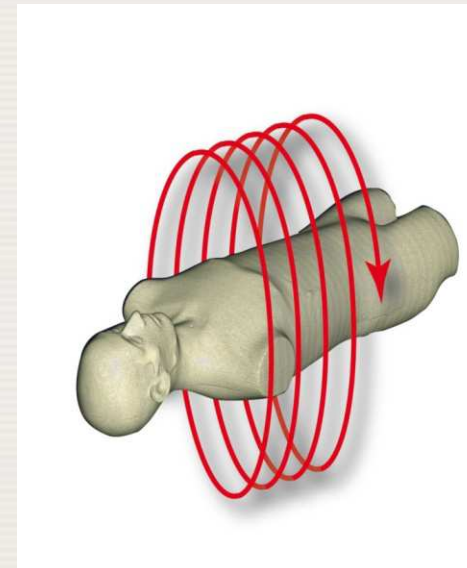
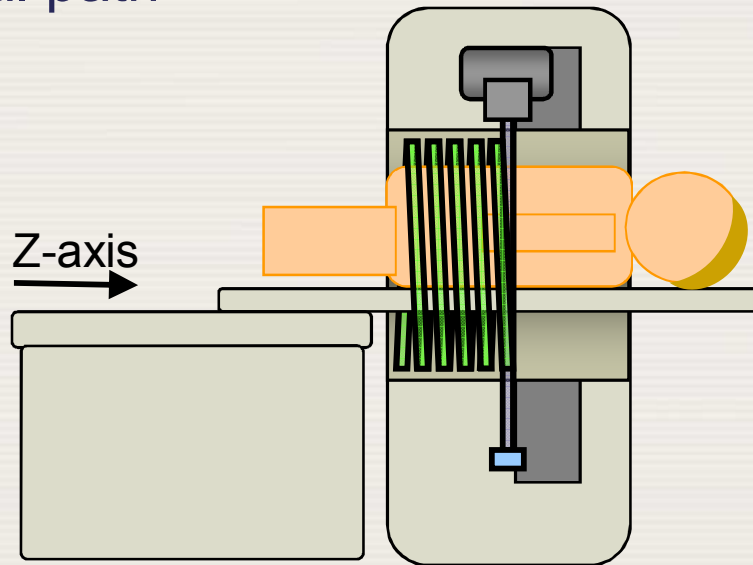

11.5 ACQUISITION

11.5.3 Helical CT scan

- The introduction of helical CT scans improved the performance of computed tomography considerably.
 - Some advantages of helical CT scans are shorter examination scan times,
 - more consistent 3D image information of the scanned volume since images can be reconstructed at any z-axis position.
 - Disadvantages of helical CT scans were introduction of artefacts such as windmill artefacts.
- Helical scanning allows for the acquisition of a large volume of interest within one breathhold and it was a prerequisite for the development of high quality CT angiography.

11.5 ACQUISITION

11.5.3 Helical CT scan

- The table translation is generally expressed relative to the (nominal) beam width (in single slice CT this equals the slice width): the ratio of table translation per 360° tube rotation relative to the nominal beam width is in helical CT referred to as the pitch factor.

$$\text{Pitch} = \frac{\text{table travel / rotation}}{\text{X-ray beam width}}$$

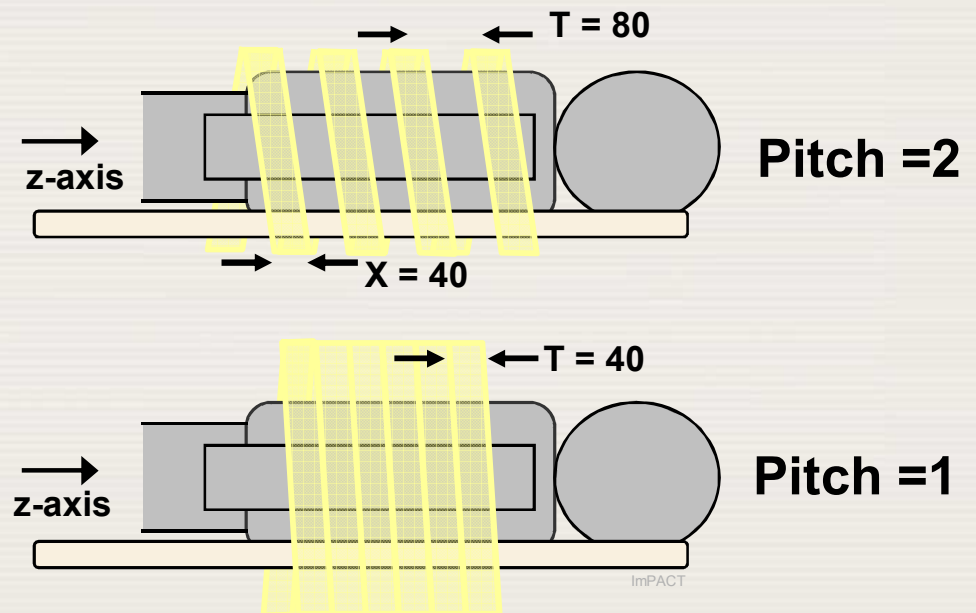

11.5 ACQUISITION

11.5.4 MDCT scan

- ❑ The introduction of fast rotating multislice CT scanners occurred in the late 1990's – ten years after the introduction of helical CT.
 - This provided the preconditions for new clinical applications
- ❑ In single slice CT scanners only one linear array of detectors was used
 - The rotation time of single slice CT scanners was 1-2 s, the slice thickness (and nominal beam width) in most clinical applications 5-10 mm.
- ❑ In multislice scanners 4, 16 and 64 adjacent active arrays of detectors were used, enabling the simultaneous measurement of a corresponding large number of transmission profiles.

11.5 ACQUISITION

11.5.4 MDCT scan

- ❑ At the same time the rotation time dropped to well below 1 s, to 0.3-0.4 s.
- ❑ Consequently, with fast multislice CT scanners it is possible to scan almost the entire body of an adult within one breathhold at a slice thickness well below 1 mm.
- ❑ Acquisitions with multi-detector row CT scanners are usually operated in a helical mode.
 - Exemptions are for example high resolution CT of the lungs, and step and shoot cardiac CT for either coronary calcium scoring or coronary CT angiography.

11.5 ACQUISITION

11.5.5 Cardiac CT

□ Cardiac CT is based on the synchronization of image reconstruction with the ECG and selection of the best cardiac rest phase.

- The figure shows reconstructions of the heart at different cardiac phases demonstrating the difference in blurring of the coronary arteries at different cardiac phases.
- Here the cardiac phase corresponding with 70% of the RR interval produces the best, motion free, result (70% marks the start of the cardiac phase interval)

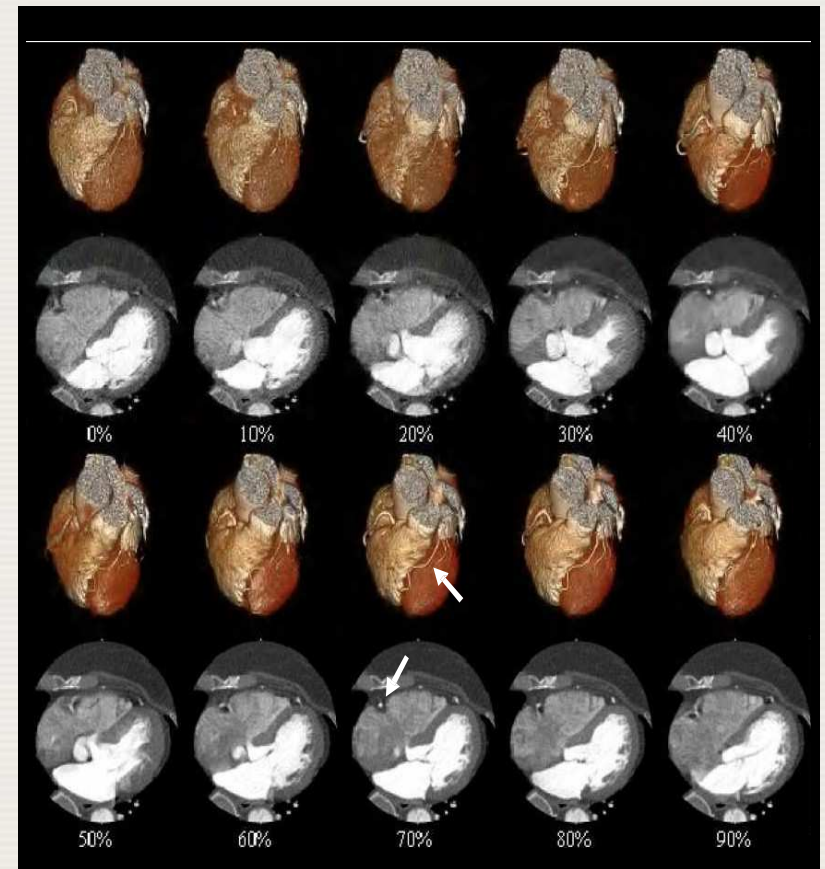

11.5 ACQUISITION

11.5.5 Cardiac CT

- ❑ Cardiac scanning requires the cardiac motion to be minimised. Therefore to “freeze” the motion
 - Image during phase of least cardiac motion (generally diastole, or end systole)

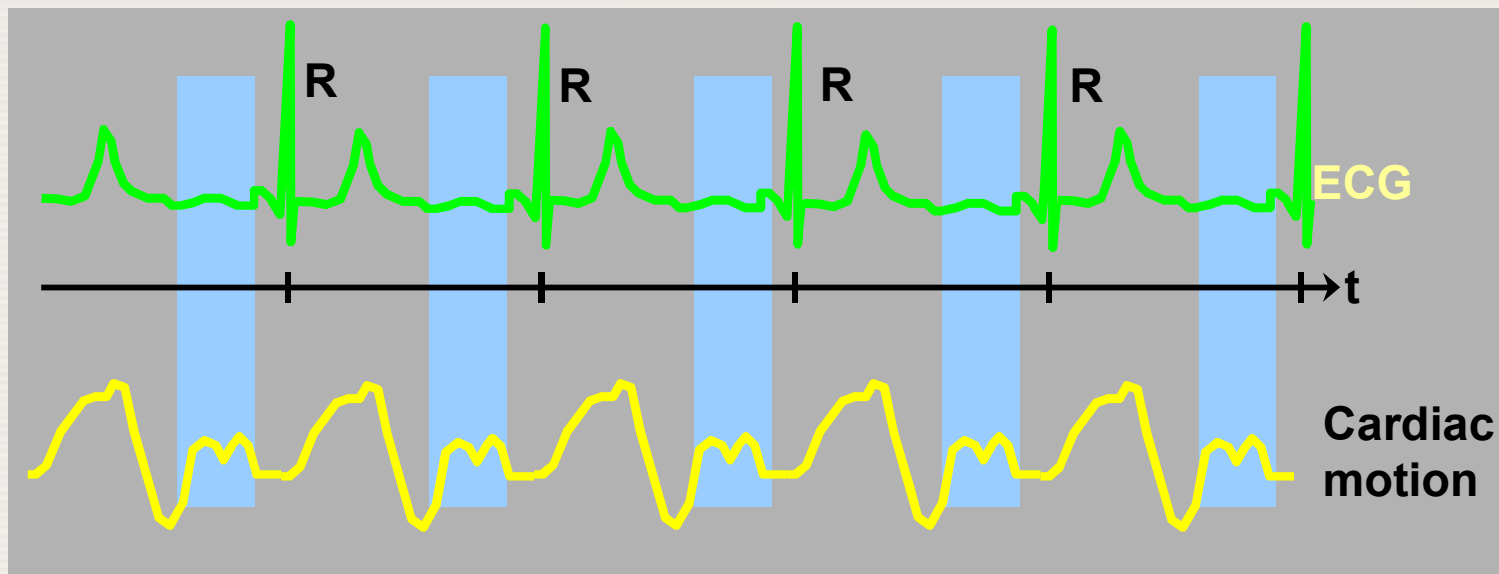

11.5 ACQUISITION

11.5.5 Cardiac CT

- ❑ Cardiac reconstruction can be retrospective ECG-gated reconstructions and prospective ECG-triggered reconstructions.
- ❑ In both cases the ECG of the patient is linked to the scanner in order to trigger the scan or to link the acquired data with the heart phase retrospectively.
 - In reality it is used for both purposes – to a greater and lesser extent depending on the type of process.

11.5 ACQUISITION

11.5.5 Cardiac CT

□ Retrospective ECG-gated reconstructions

- A **helical** scan is performed with an overlapping pitch
- The cardiac phase selection data is selected retrospectively based on registration of the raw data and the ECG during one or more entire cardiac cycles.
- To reduce the radiation dose in the phases that are not of interest **ECG dose modulation** is used.

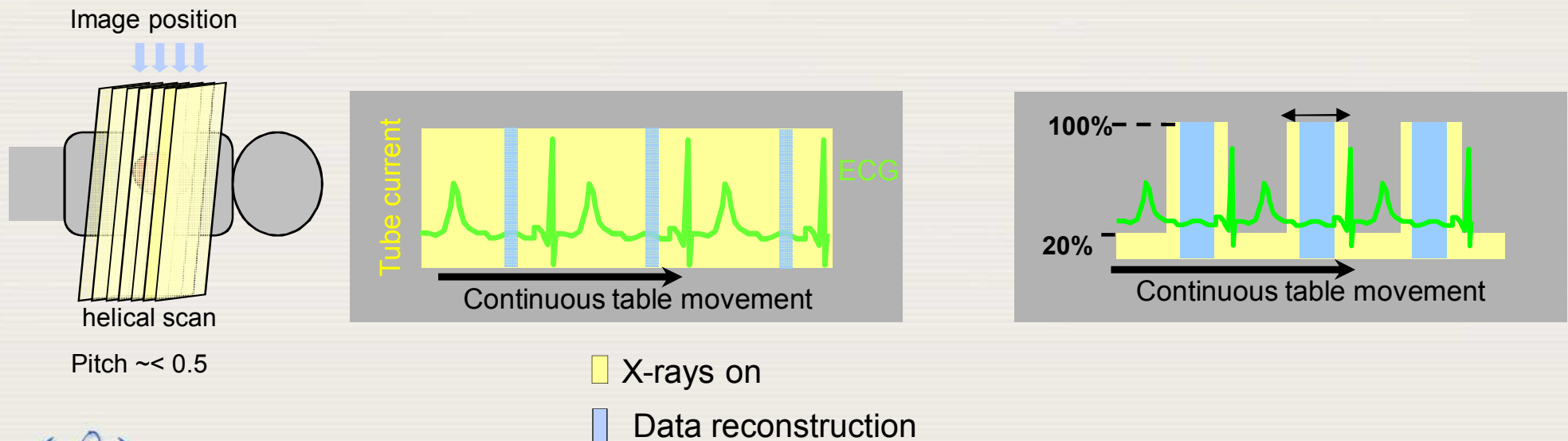

11.5 ACQUISITION

11.5.5 Cardiac CT

- **Prospective ECG-triggered** reconstructions are “**step-and-shoot**” (i.e. “**axial**”) acquisitions. An advantage of such acquisitions is the reduction of patient dose.

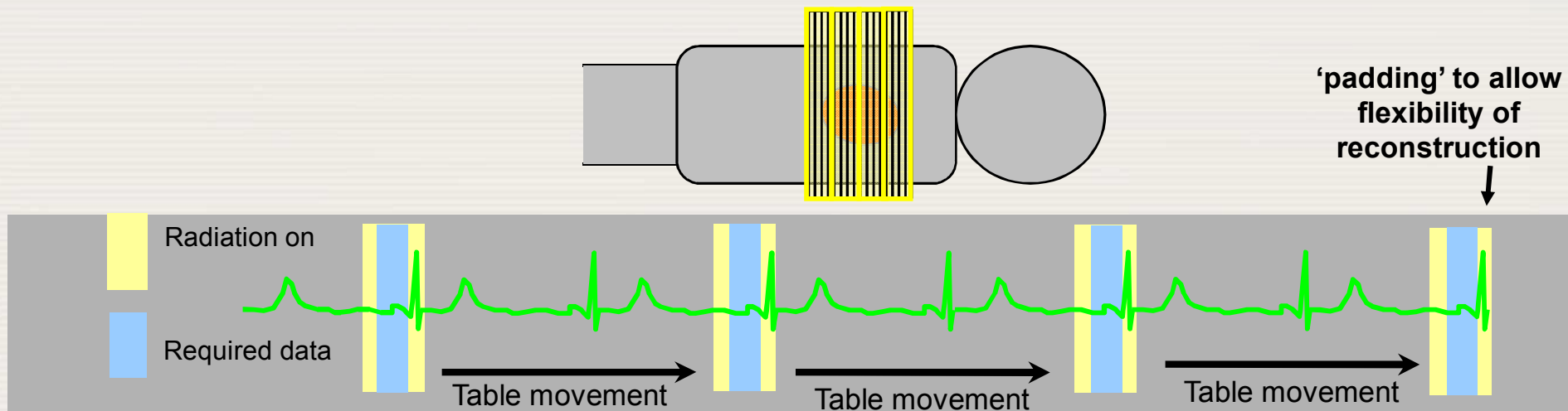

11.5 ACQUISITION

11.5.5 Cardiac CT

- ❑ Some CT scanners allow for **prospective** scanning of the entire heart within one single heartbeat at the preselected cardiac rest phase:
 - a fast dual-source CT scanner is capable to perform a helical acquisition of the entire heart (Siemens Definition Flash)
 - and a wide cone-beam CT scanner performs an acquisition of the entire heart within one single rotation (Toshiba Aquilion ONE).
- ❑ Such novel “single heart beat” techniques carry the promise of substantial dose reduction.

11.5 ACQUISITION

11.5.5 Cardiac CT

□ Summary of cardiac scanning modes

Scanning mode	Cardiac mode	Features
“step and shoot” / Axial / Sequence	Prospective triggering	Padding – to provide greater flexibility of reconstruction
Helical	Retrospective gating	ECG modulation – to provide reduced dose from constant irradiation. Some margin left for flexibility of reconstruction

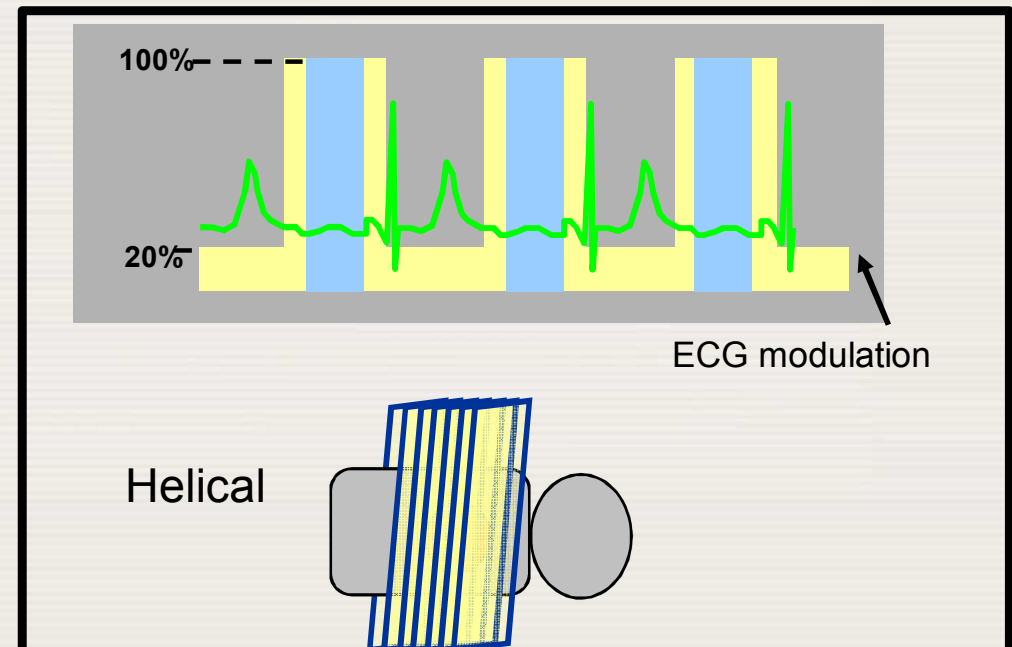

11.5 ACQUISITION

11.5.6 CT fluoroscopy and interventional procedures

- ❑ **Dynamic CT** can be used for image guided interventions, this technique is referred to as **CT fluoroscopy**.
- ❑ Technical developments in CT that have provided the technical preconditions for **CT fluoroscopy**
 - continuous rotating X-ray tube, short rotation time
 - hardware fast enough for real- time image reconstructions.
- ❑ The **first clinical application** of CT fluoroscopy dates back to 1993, multislice CT fluoroscopy was introduced in 1999.

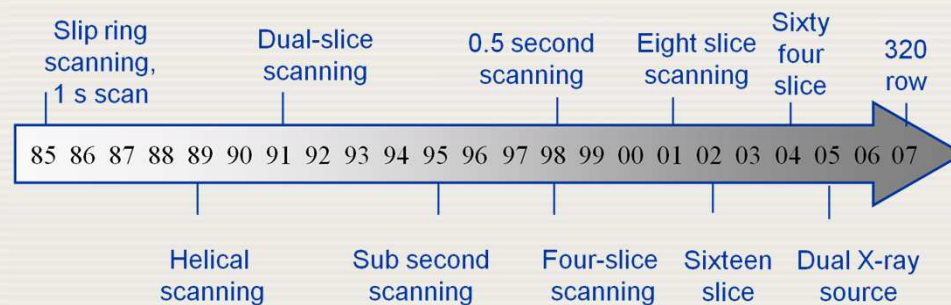

ImPACT

11.5 ACQUISITION

11.5.6 CT fluoroscopy and interventional procedures

- **Additional hardware** required for **CT fluoroscopy** includes a device that allows for operating the CT scanner from within the CT room, and installation of monitors in the CT room that allow for displaying the CT images.



11.5 ACQUISITION

11.5.6 CT fluoroscopy and interventional procedures

- A diagnostic plan scan that is used for preparing a puncture.
 - The markers on the skin allow for planning of the entrance position of the needle.
 - The diagnostic CT scan allows also for identifying the target of the puncture – greatly helped with multi-slice axial scanning
 - During a CT fluoroscopy guided puncture the position of the needle can be visualized accurately

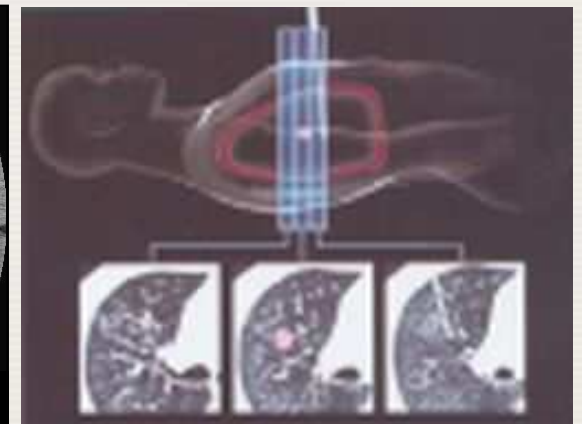
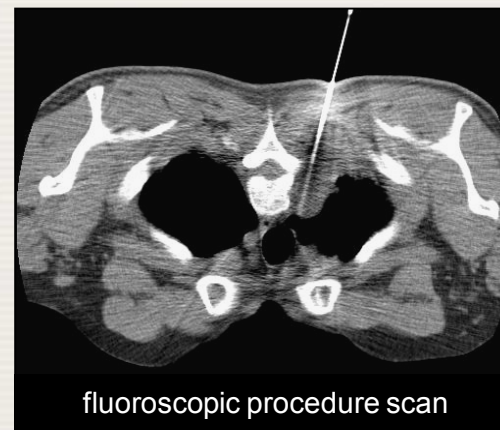
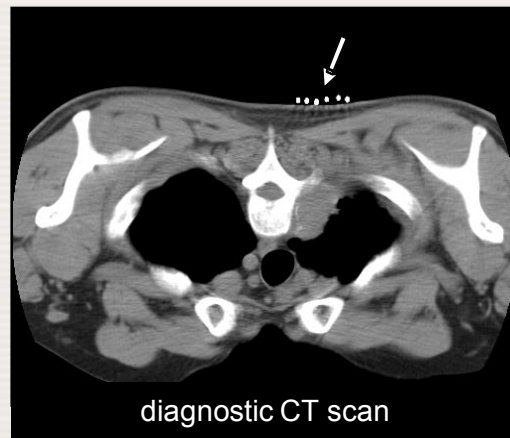

11.5 ACQUISITION

11.5.6 CT fluoroscopy and interventional procedures

- ❑ The noise is much higher in the image of the CT fluoroscopy guided puncture compared to the diagnostic plan scan.
- ❑ During CT fluoroscopy modest image quality is usually sufficient
- ❑ CT fluoroscopy should be performed using a relatively low tube current in order to reduce exposure of the patient and medical staff.

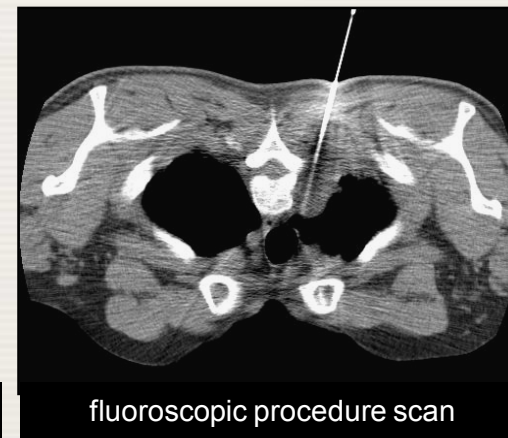
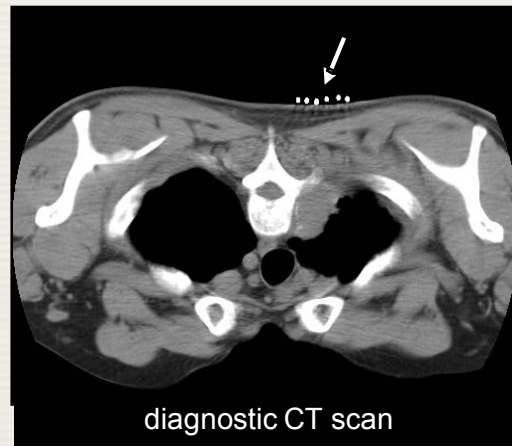

11.5 ACQUISITION

11.5.6 CT fluoroscopy and interventional procedures

- ❑ The number of clinical indications for multislice CT fluoroscopy is growing
- ❑ CT fluoroscopy is routinely used for taking difficult biopsies.
- ❑ Relatively new clinical applications are guidance of RF ablations, vertebroplasty, kyphoplasty and alcohol ablation of tumors.

11.5 ACQUISITION

11.5.6 CT fluoroscopy and interventional procedures

- ❑ In CT fluoroscopy special care for proper radiation protection is required.
- ❑ Entrance skin dose for the patient should be monitored to ensure that deterministic skin effects will not occur.
- ❑ The operator should adhere to the same precautions as in regular fluoroscopy: the number of CT acquisitions should be as few as possible and the duration of the acquisitions as short as possible.

11.5 ACQUISITION

11.5.6 CT fluoroscopy and interventional procedures

- ❑ A low dose single rotation axial scan is often sufficient to obtain information about the status of the procedure
- ❑ Dynamic CT fluoroscopy should only be applied when one axial scan does not provide sufficient information.
- ❑ Workers present in the CT room during CT fluoroscopy should be protected against exposure to scattered radiation by wearing a lead apron.
- ❑ They should also maintain as much distance to the scanner as possible to limit their exposure to scattered radiation.

11.5 ACQUISITION

11.5.6 CT fluoroscopy and interventional procedures

- ❑ Special care should be taken to avoid direct exposure of the hand of the operator, the operator should manipulate the needle during CT fluoroscopy only with a special needle holder that provides extra distance between the hand of the operator and the X-ray beam, thus direct exposure of the hand can be avoided.



11.5 ACQUISITION

11.5.7 Dental CT

- ❑ CT scans of the jaw can be made with any regular CT scanner, but dedicated volume (cone beam) CT scanners for dental imaging are also available
- ❑ These are designed for the patient to be seated.



11.5 ACQUISITION

11.5.7 Dental CT

- ❑ The dental CT units use different components compared to the whole body CT scanners.
- ❑ Dental CT scanners have
 - a compact x ray tube (with a relatively low output)
 - Usually a flat panel detector - comparable to those that can be found in X-ray units for digital projection radiography.

11.5 ACQUISITION

11.5.7 Dental CT

□ Dental CT scanners

- provide sufficient image quality for CT dental applications at relatively low costs.
- but offer poor performance with regard to low contrast resolution, this means that soft tissues cannot be assessed appropriately in the reconstructed images.

11.5 ACQUISITION

11.5.7 Dental CT

- ❑ This does not, in general, impose a limitation for the clinical application of these compact cone beam CT scanners in dental imaging, but it does limit their potential for application in other fields of medical imaging.
- ❑ The design of the dental cone beam scanners puts also a limitation on the rotating speed of the arm on which the x ray tube and detector are mounted.
- ❑ This means that the rotation time is relatively long. The dental CT scanners yield thin axial images of the jaw which can be reformatted into multiple panoramic and cross-sectional views.

11.5 ACQUISITION

11.5.8 Contrast enhanced CT

- ❑ In contrast enhanced CT, contrast is artificially created between structures that would not be visible on non enhanced scans.
- ❑ In CT angiography, iodine is administered during the CT scan intravenously to enhance the contrast between the vessels and the vessel wall

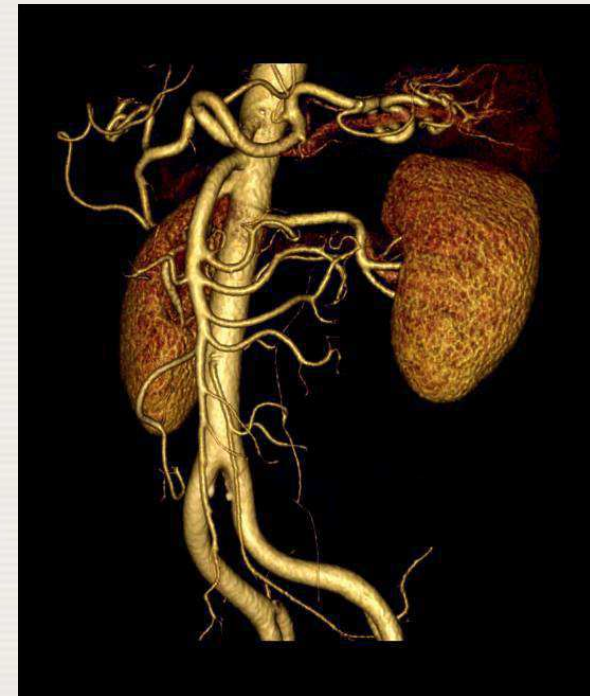

11.5 ACQUISITION

11.5.8 Contrast enhanced CT

- ❑ In certain studies of the abdomen, a diluted iodine solution is administered orally prior to the CT to enhance contrast within the gastro intestinal tract.
- ❑ In CT colonography gas may be inflated through the rectum to enhance contrast between the colon and its surrounding tissues

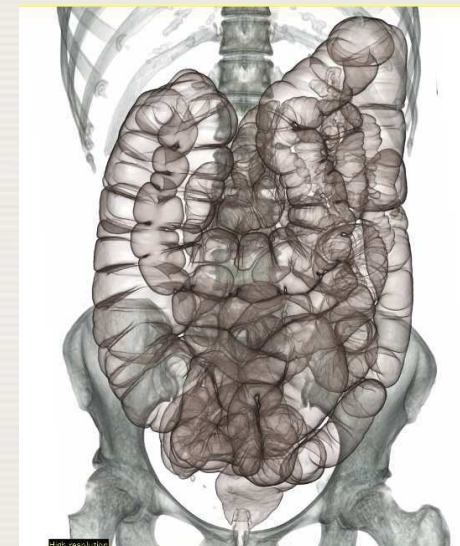
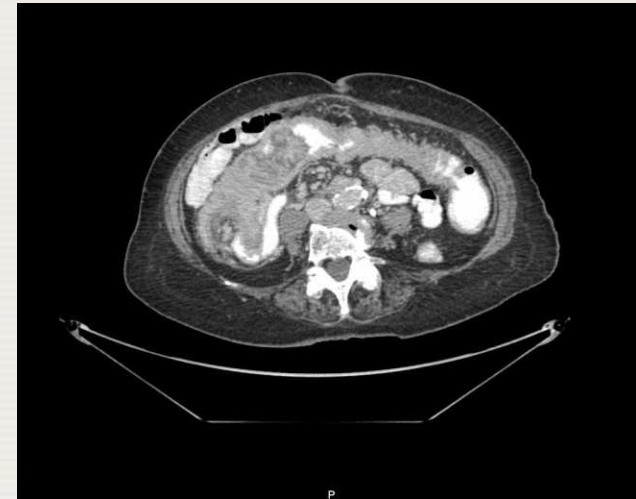

11.5 ACQUISITION

11.5.7 Special applications

- ❑ Special applications of CT include a well established application of CT for radiotherapy treatment planning
- ❑ Also more experimental applications like dual energy CT imaging and dynamic volumetric CT studies.

11.5 ACQUISITION

11.5.7 Special applications

- ❑ In CT for **radiotherapy treatment planning** the patient is scanned in the position that will be applied during the radiotherapy sessions.
- ❑ Special **wide bore scanners** provide a gantry opening that is large enough to allow that a patient is scanned in such a position. They offer a large field of view.

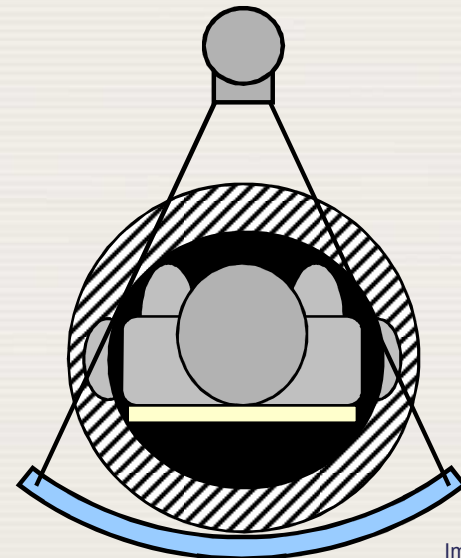
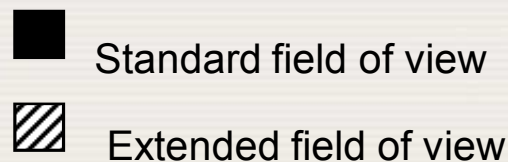

ImPACT

11.5 ACQUISITION

11.5.7 Special applications

- ❑ **Dual energy CT imaging** requires imaging of the volume of interest at two different (average photon) energies.
 - The volume of interest is scanned at two different tube voltages.
 - Extra filtration of the beam can also be used to further optimize the two X-ray spectra.
- ❑ **Dual energy CT** might allow for better discrimination of certain tissues and pathology.

11.5 ACQUISITION

11.5.7 Special applications

□ Dual energy CT

- May provide accurate differentiation between urinary stones that do and do not contain uric acid.
- Might improve the visualization of tendons of the hand and foot, it might also support bone removal
- Provides an additional method that can remove bony structures from CT angiography scans

11.5 ACQUISITION

11.5.7 Special applications

- ❑ Some scanners allow for **dynamic CT imaging**, i.e. a dynamic process in the volume of interest can be followed as a function of time.
 - Such studies are also referred to as 4D CT.
- ❑ Dynamic CT studies can for example visualize the movement of joints or the contrast enhancement of in organs (perfusion or dynamic CT angiography).
- ❑ Figure 21 shows an example of a dynamic CT angiography study of the brain with a volumetric CT scanner that covers the entire brain (Aquilion ONE, Toshiba).

11.5 ACQUISITION

11.5.7 Special applications

□ A dynamic CT angiography study of the brain with a volumetric CT scanner that covers the entire brain

- In the images time resolved contrast enhancement of the vessels in the brain allows for following the enhancement of arterial and venous components of the angiogram.

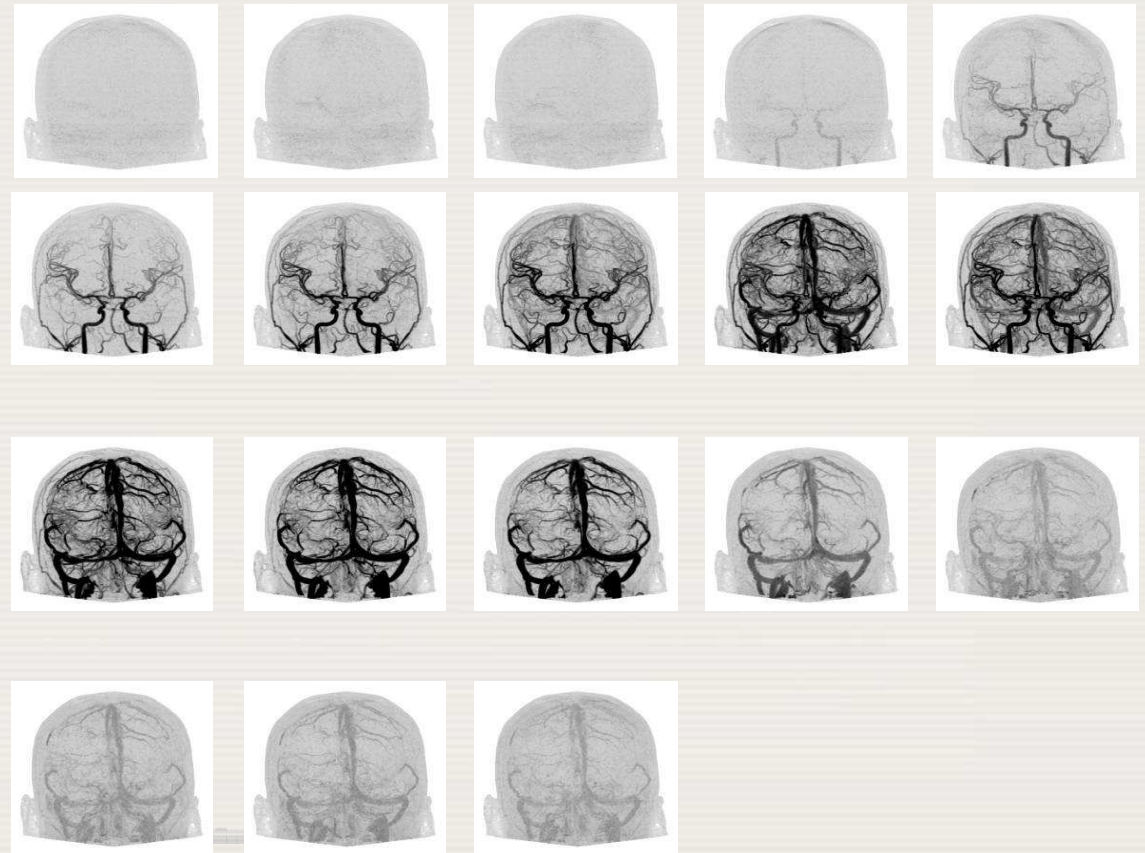

(Aquilion ONE, Toshiba).

11.5 ACQUISITION

11.5.7 Special applications

- ❑ **CT perfusion studies** of organs such as the brain, the heart, and the liver have also become possible.
- ❑ During **dynamic CT studies**, the operator should be aware that skin dose might accumulate rapidly, during such studies patient skin dose should be maintained below 2 Gy to avoid the risk of induction of deterministic skin effects such as erythema and epilation.

11.6 COMPUTED TOMOGRAPHY IMAGE QUALITY

11.6.1 Image quality

- ❑ Excellent **low-contrast resolution** of computed tomography distinguishes **computed tomography** from **radiography** and **planigraphy**.
- ❑ **Low-contrast resolution** is the ability to detect structures that offer only a **small difference in signal** (expressed in Hounsfield units) compared to their direct environment.
- ❑ **Image noise** is the main limitation for **low-contrast resolution**.

11.6 COMPUTED TOMOGRAPHY IMAGE QUALITY

11.6.1 Image quality

- ❑ **Image noise** may be decreased either by increasing tube current (mA) at the cost of patient exposure, or by increasing the reconstructed slice thickness, at the cost of spatial resolution.
- ❑ In addition, **low-contrast resolution** depends on tube voltage, beam filtration and the reconstruction algorithm.

11.6 COMPUTED TOMOGRAPHY IMAGE QUALITY

11.6.1 Image quality

- Example - A contrast enhanced CT scan of the liver.
 - The 100% image corresponds with the actual clinical acquisition.
 - Simulated noise has been added to the raw data to simulate image quality for acquisitions that are performed at 75%, 50% and 25% of the clinically used tube current.
 - The appearance of the low contrast lesions in the liver becomes worse at lower tube currents due to increased noise in the images.

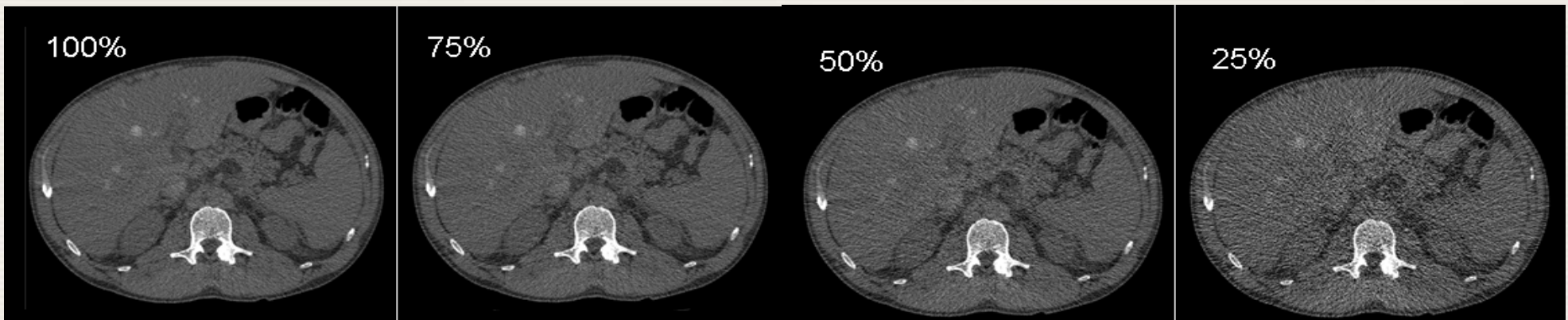

11.6 COMPUTED TOMOGRAPHY IMAGE QUALITY

11.6.1 Image quality

- ❑ Physicists usually assess **low-contrast resolution** with phantoms that contain different sized low-contrast inserts.
 - With a phantom low-contrast resolution can be assessed either subjectively by an observer that has to decide whether an insert is visible or not, or objectively by calculating the contrast to noise ratio.
- ❑ The **noise power spectrum** would provide an objective measure of scanner performance but is not yet applied on a large scale.

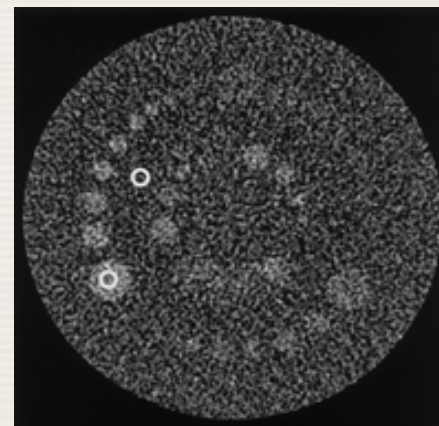

Image of low contrast detectability test object

11.6 COMPUTED TOMOGRAPHY IMAGE QUALITY

11.6.1 Image quality

- ❑ **Spatial resolution**, or **high-contrast resolution**, is the ability to observe contours of small objects within the scanned volume.
- ❑ Small objects can only be resolved well when they exhibit a rather large difference in signal (**Hounsfield units**) compared to their direct environment.
- ❑ **Voxel size** is often used as an indicator of spatial resolution,
 - However voxel size should be interpreted with care since smaller voxel size does not necessarily imply better spatial resolution.

11.6 COMPUTED TOMOGRAPHY IMAGE QUALITY

11.6.1 Image quality

- ❑ **Spatial resolution** is preferably expressed as the response to a delta-function
- ❑ In computed tomography this response is either called
 - a **point-spread-function** (spatial resolution in the axial plane)
 - or a **slice sensitivity profile** (spatial resolution along the z-axis).
- ❑ The response is often quantified as the **full-width at half-maximum (FWHM)**.
- ❑ The **modulation transfer function (MTF)** would yield useful information on image quality as a function of frequency, however clinical assessment of the **MTF** is complicated and not routinely performed by medical physicists.

11.6 COMPUTED TOMOGRAPHY IMAGE QUALITY

11.6.1 Image quality

- ❑ Manufacturers of CT scanners do provide information about the **MTF**, however these **MTF data** should be interpreted with care since no general international standard for measuring the **MTF** of CT scanners has been implemented yet.
- ❑ Spatial resolution is limited by the **acquisition geometry** of the CT scanner, **the reconstruction algorithm** and the **reconstructed slice thickness**.

11.6 COMPUTED TOMOGRAPHY IMAGE QUALITY

11.6.1 Image quality

- The performance of current 64-slice scanners with regard to spatial resolution, expressed as **the full-width half-maximum of the point spread function**, is within the range **0.6-0.9 mm** in all 3 dimensions.

11.6 COMPUTED TOMOGRAPHY IMAGE QUALITY

11.6.1 Image quality

- ❑ The CatPhan phantom that is widely used to evaluate image quality of CT scans.
- ❑ To check the numerical value of Hounsfield units in the reconstructed image four large inserts in the periphery of the phantom represent
 - air, -1000 HU, low density polyethylene, -100 HU, Acrylic, +115 HU, and Teflon, +990 HU, (the background is +90 HU).
- ❑ Low contrast Acrylic inserts of different diameters around the center allow for exploring the effect of object size on low contrast detectability.

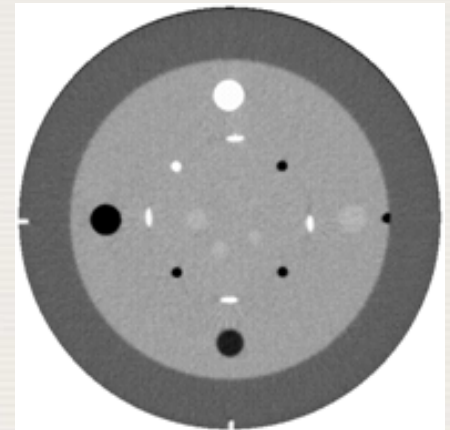

11.6 COMPUTED TOMOGRAPHY IMAGE QUALITY

11.6.1 Image quality

- ❑ **High contrast line pairs** allow for assessment of spatial resolution (top image).
- ❑ Alternatively, **spatial resolution** can also be measured as the **point spread function of a small (tungsten) bead** (lower image).
- ❑ This image can also be used to assess the **homogeneity of Hounsfield units** in the image.

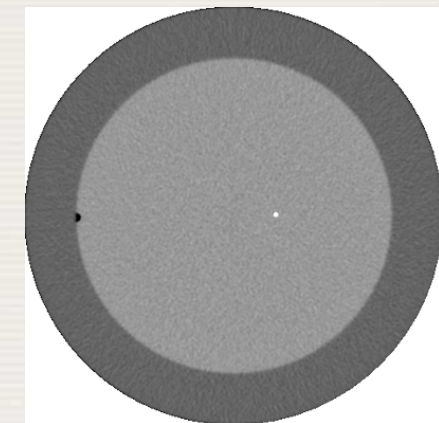
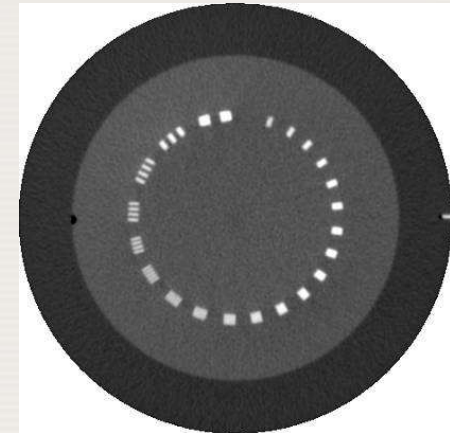

11.6 COMPUTED TOMOGRAPHY IMAGE QUALITY

11.6.1 Image quality

- ❑ **Temporal resolution** is the ability to resolve fast moving objects in the displayed CT image.
- ❑ Good **temporal resolution** avoids **motion artefacts** and **motion induced blurring** of the image.
- ❑ A good **temporal resolution** in CT is realized by fast data acquisition (fast rotation of the X-ray tube).

11.6 COMPUTED TOMOGRAPHY IMAGE QUALITY

11.6.1 Image quality

- ❑ **Reconstruction algorithms** that are used for general CT applications provide in principle a temporal resolution equal to the rotation time (360° rotation, full reconstruction), the best routinely achievable temporal resolution is slightly longer than 50% of the rotation time (180° + fan angle rotation).
- ❑ **Temporal resolution** can be improved further by using dedicated reconstruction algorithms (cardiac CT with a segmented reconstruction) or by using a dual source CT scanner. There are no simple methodologies available yet that allow for measuring temporal resolution in a clinical setting.

11.6 COMPUTED TOMOGRAPHY IMAGE QUALITY

11.6.2 Clinical observer studies

- ❑ **Fundamental (physical) image quality quantities** and ratings of observations of test objects yield information on CT scanner performance.
 - These are best used for **product specification** and for **quality control**
 - They are not sufficient for development of clinical acquisition protocols for CT scanners
- ❑ **Clinical image quality requirements for specific clinical tasks**
 - are largely unknown in terms of image quality quantities or measurable test object parameters

11.6 COMPUTED TOMOGRAPHY IMAGE QUALITY

11.6.2 Clinical observer studies

- ❑ **Clinical acquisition protocols** in computed tomography are
 - Largely based on experience and consensus
 - Preferably would be based on clinical observer studies and appropriate scientific evidence.
- ❑ **Observer studies** to optimizing acquisition protocols are rare in computed tomography
 - It is inappropriate to undertake multiple scans on one patient to the unjustified extra radiation exposure

11.6 COMPUTED TOMOGRAPHY IMAGE QUALITY

11.6.2 Clinical observer studies

- **Optimising** the effect of increased image noise due to lower tube current (mAs) can be simulated with mathematical models that add noise to the raw data
 - After adding noise to the raw data, images can be reconstructed and such images can be used in observer studies to determine the noise that can be allowed in the images for specific observer tasks
 - Algorithms for performing such studies are however not widely available

11.6 COMPUTED TOMOGRAPHY IMAGE QUALITY

11.6.2 Clinical observer studies

- Example: an original cardiac CT scan and three additional images that were derived with the aid of a mathematical low dose simulation.

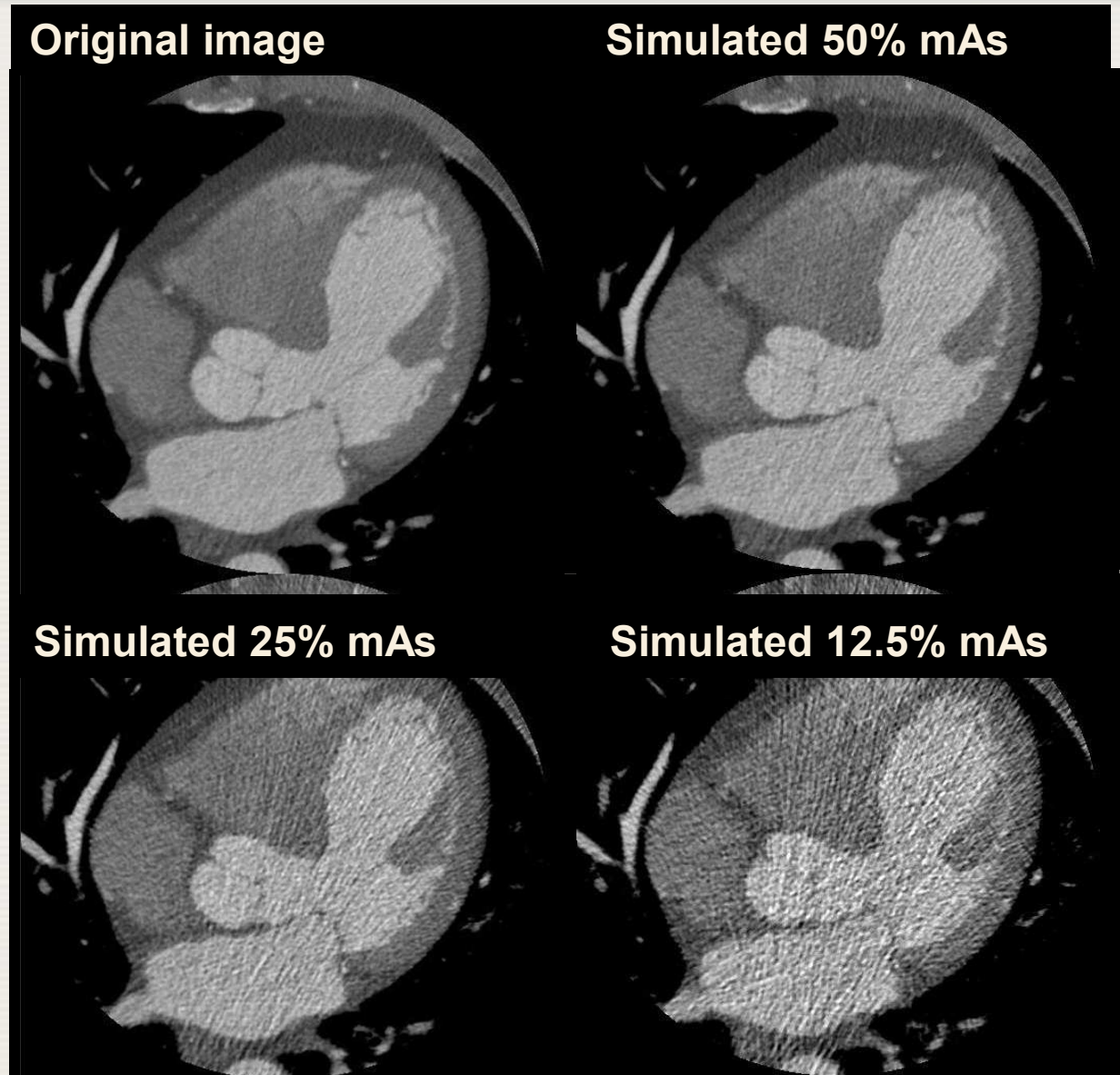

11.6 COMPUTED TOMOGRAPHY IMAGE QUALITY

11.6.2 Clinical observer studies

- Optimisation of the tube voltage is
 - More difficult to achieve since no appropriate algorithms have been described for simulating the effect of tube voltage on image quality.
 - Mainly based on theoretical considerations, on phantom studies (for example aiming at achieving the optimal contrast to noise ratio in iodine enhance CT angiography studies) and on observer consensus.

11.6 COMPUTED TOMOGRAPHY IMAGE QUALITY

11.6.3 Effect of acquisition and reconstruction parameters on image quality

- ❑ The main acquisition parameters in computed tomography are tube voltage, tube current and rotation time
- ❑ A relatively high tube voltage (120 kV - 140 kV) is used in computed tomography to achieve good X-ray transmission and sufficient detector signal
- ❑ 80 – 100 kV may be used for special applications such as contrast enhanced studies and paediatric CT

11.6 COMPUTED TOMOGRAPHY IMAGE QUALITY

11.6.3 Effect of acquisition and reconstruction parameters on image quality

- ❑ The **tube current** used in computed tomography is limited by
 - the required long scan time
 - the heat capacity of the X-ray tube
 - radiation protection of the patient considerations.
- ❑ To avoid **motion artefacts** in CT the rotation time is preferably as short as possible
- ❑ For scans that are less prone to motion artefacts, and that require good low-contrast resolution (such as scans of the brain), a longer rotation time may be selected

11.6 COMPUTED TOMOGRAPHY IMAGE QUALITY

11.6.3 Effect of acquisition and reconstruction parameters on image quality

- Many reconstruction and viewing parameters have an effect on image quality and observer performance.
 - For example the reconstructed slice thickness, the reconstruction filter, the windowing, and the image reformats

11.6 COMPUTED TOMOGRAPHY IMAGE QUALITY

11.6.3 Effect of acquisition and reconstruction parameters on image quality

□ Example:

- Three reconstructions of the same acquisition reconstructed using three different slice thicknesses
- Note that both in the volume rendering (left), and in the coronal images (right), the spatial resolution in the coronal plane improves considerably at smaller slice thickness.



11.6 COMPUTED TOMOGRAPHY IMAGE QUALITY

11.6.3 Effect of acquisition and reconstruction parameters on image quality

- ❑ Any CT acquisition can be reconstructed with one or more reconstruction filters
- ❑ During image reading the radiologist can choose the appropriate window for the specific anatomy and pathology of interest

11.6 COMPUTED TOMOGRAPHY IMAGE QUALITY

11.6.3 Effect of acquisition and reconstruction parameters on image quality

□ Example: Four CT head images from the same acquisition

- Images are reconstructed with different reconstruction algorithms, and presented on different window widths and levels
- Demonstrating the presentation of different clinical detail

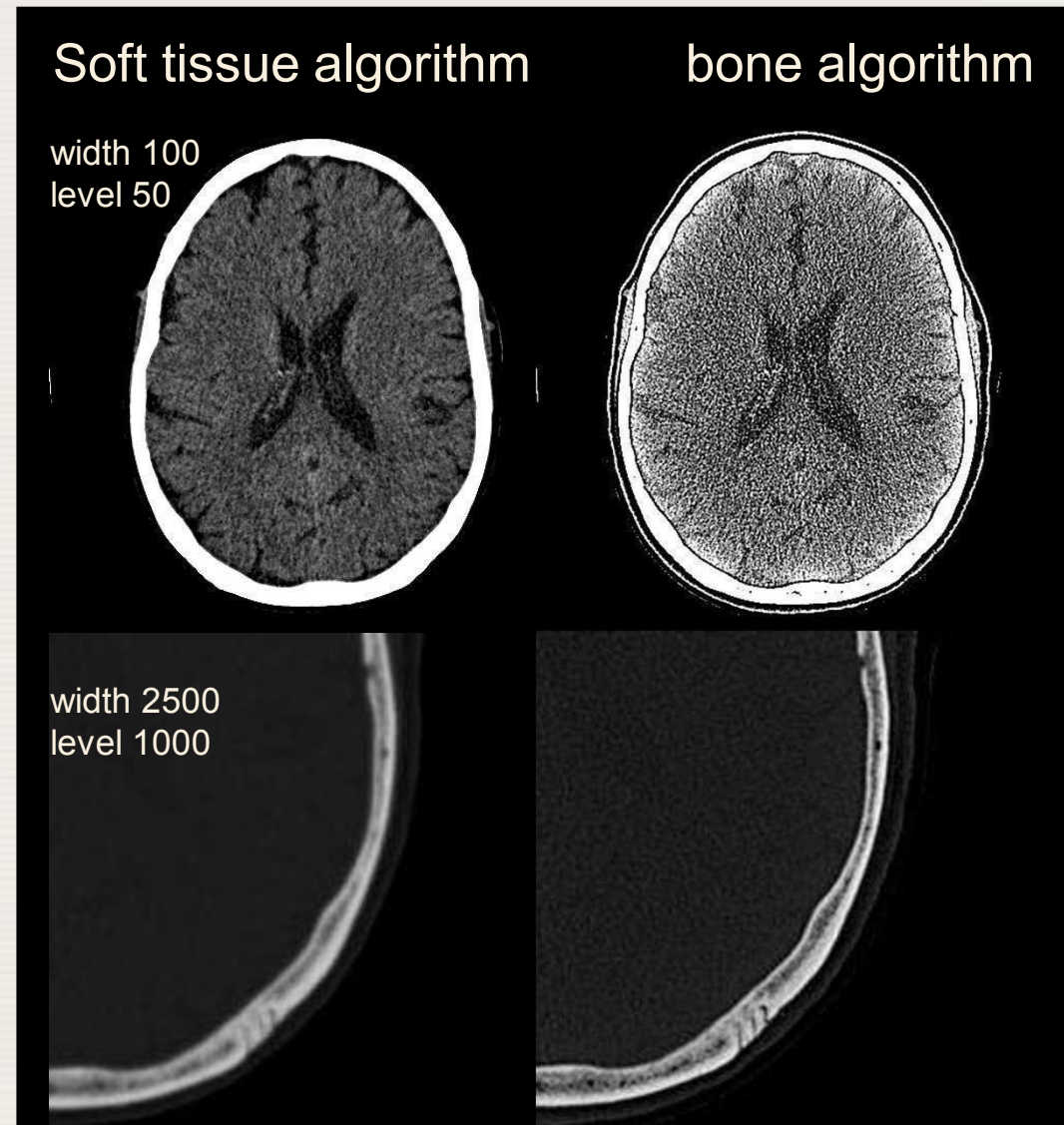

11.6 COMPUTED TOMOGRAPHY IMAGE QUALITY

11.6.3 Effect of acquisition and reconstruction parameters on image quality

Example: four axial contrast enhanced CT body images

- Images are reconstructed with different reconstruction algorithms, and presented on different window widths and levels
- The images show enhanced low contrast areas in the liver and small enhanced vessels in the lungs.

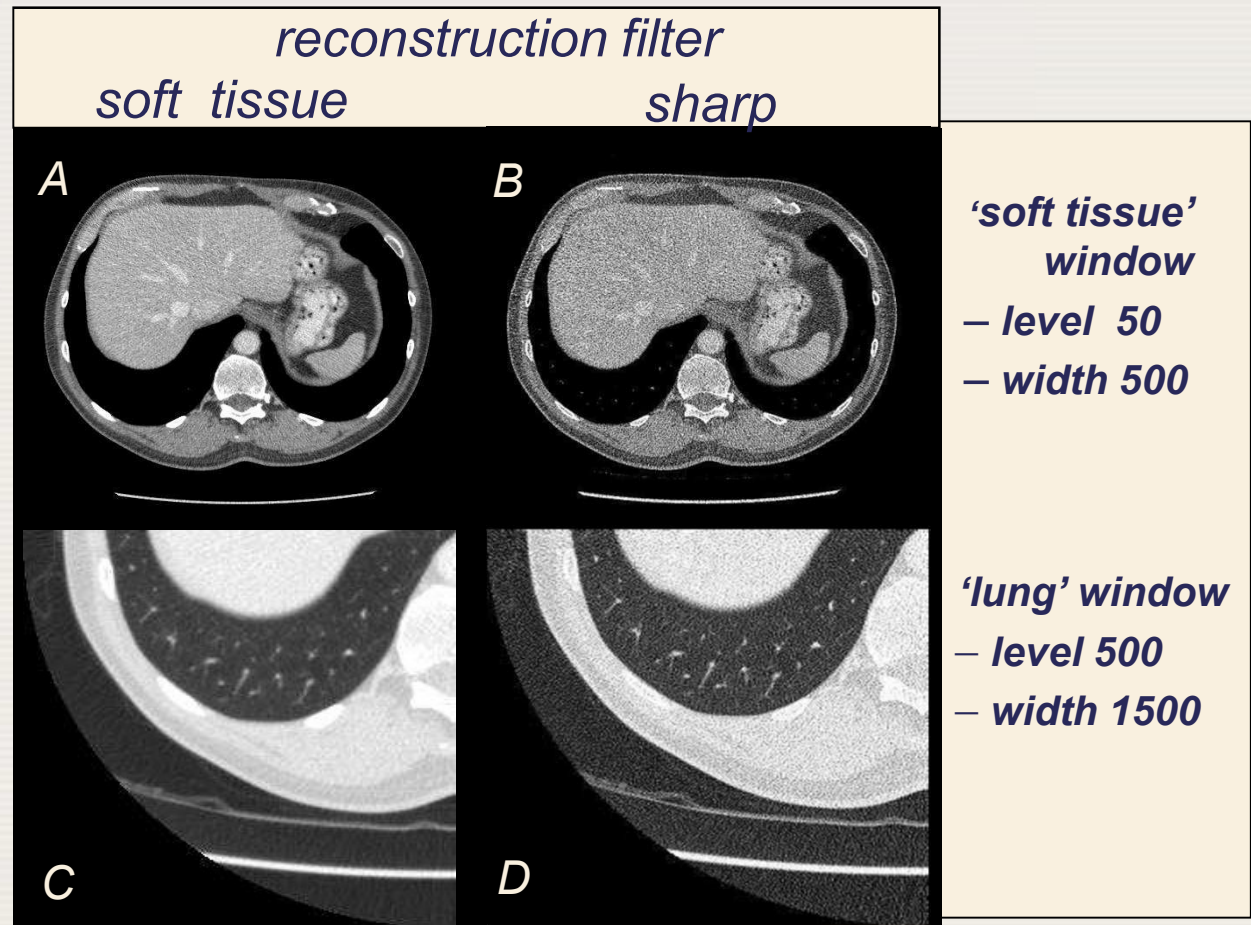

11.6 COMPUTED TOMOGRAPHY IMAGE QUALITY

11.6.3 Effect of acquisition and reconstruction parameters on image quality

- ❑ Image (A) is appropriate for evaluation of the enhanced areas in the liver, evaluation of these areas in image (B) is hampered due to image noise that results from the sharp reconstruction filter.
- ❑ Enhanced vessels in the lungs cannot be assessed well in these images due to the specific window setting for soft tissue.

'soft tissue' window
– level 50
– width 500

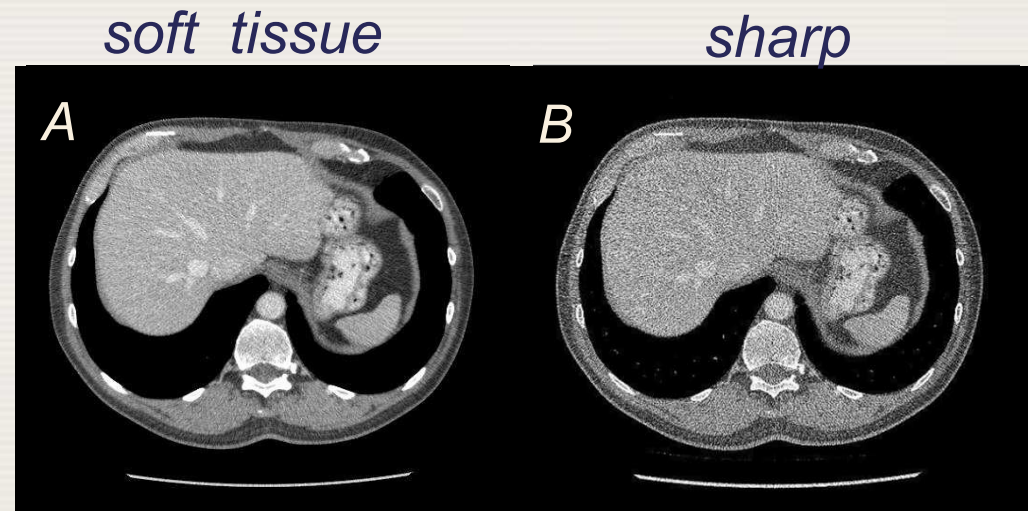

11.6 COMPUTED TOMOGRAPHY IMAGE QUALITY

11.6.3 Effect of acquisition and reconstruction parameters on image quality

□ The images in the lower row (C,D) are in a window setting that is appropriate for evaluation of the lung.

- The small enhanced vessels in the lungs are better appreciable in image (D) due to the use of a sharp reconstruction filter, evaluation of the vessels in the image Image (C) is hampered due to blurring of the vessels that results from the soft tissue reconstruction filter.
- Soft tissue cannot be assessed well in the images in C & D) due to the specific window setting for lung.

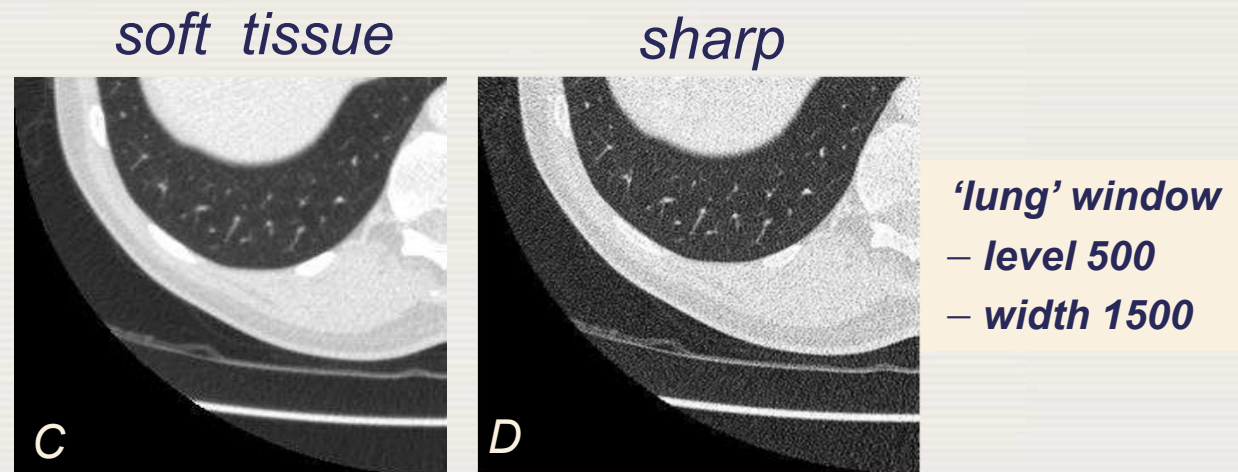

11.6 COMPUTED TOMOGRAPHY IMAGE QUALITY

11.6.3 Effect of acquisition and reconstruction parameters on image quality

- Many image reformats can be used in addition to the reading of axial images
 - Coronal, sagittal images and curved planar reformats
 - 3-dimensional views are achieved by volume rendering or surface shading algorithms
 - Planar views utilising all 3-D information is used to create maximum or minimum intensity projections (MIPs, MinIPs)

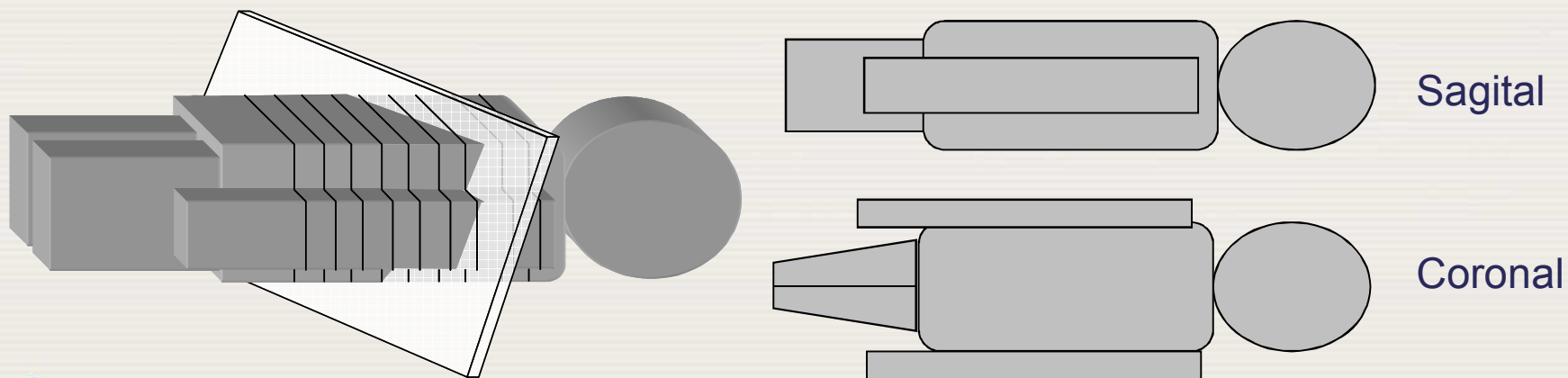

11.6 COMPUTED TOMOGRAPHY IMAGE QUALITY

11.6.3 Effect of acquisition and reconstruction parameters on image quality

□ Example:

- Axial, coronal, sagittal and volume rendered images of the brain

Axial image



Coronal image



Sagittal image



volume rendered image



11.6 COMPUTED TOMOGRAPHY IMAGE QUALITY

11.6.3 Effect of acquisition and reconstruction parameters on image quality

- Example - two images of the chest as a maximum intensity projection (MIP), and a 3D volume rendered image.

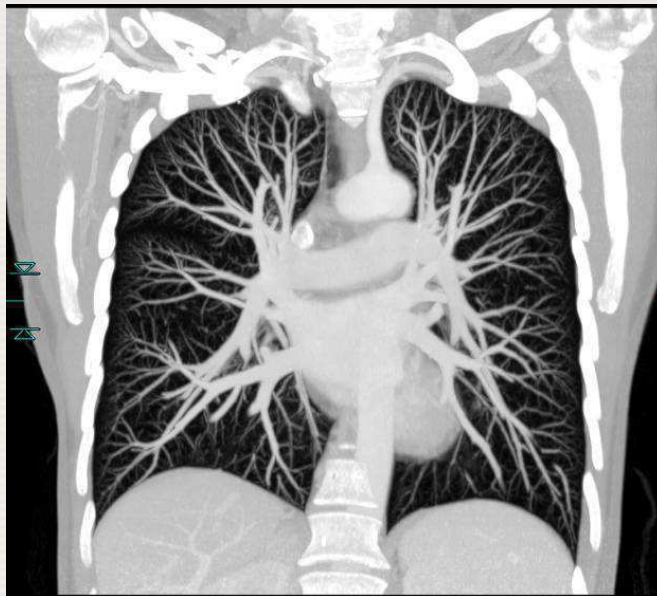

maximum intensity
projection(MIP)

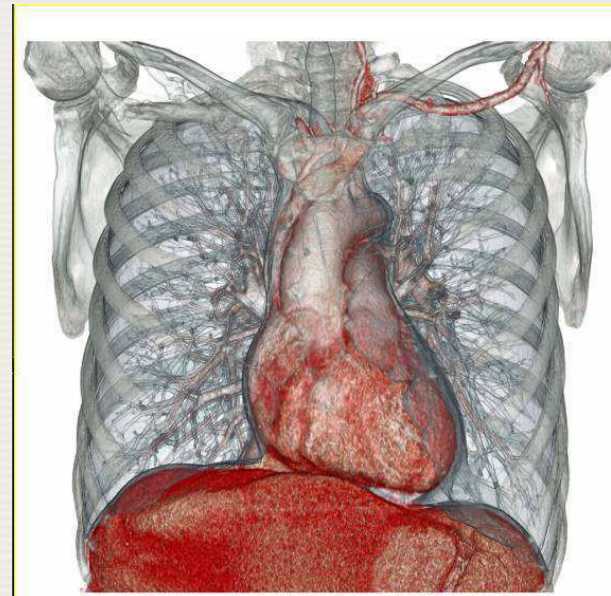

3D volume rendered image.

11.6 COMPUTED TOMOGRAPHY IMAGE QUALITY

11.6.3 Effect of acquisition and reconstruction parameters on image quality

- Example: The heart chambers and the coronary arteries are shown in simple and curved 2D reformats.
 - The MPR's are angulated relative to the axial images to better visualize the heart chambers
 - The coronary arteries are visualized as curved MPR's to allow for visualization of the coronary arteries with their complex 3D curvatures in a 2D plane

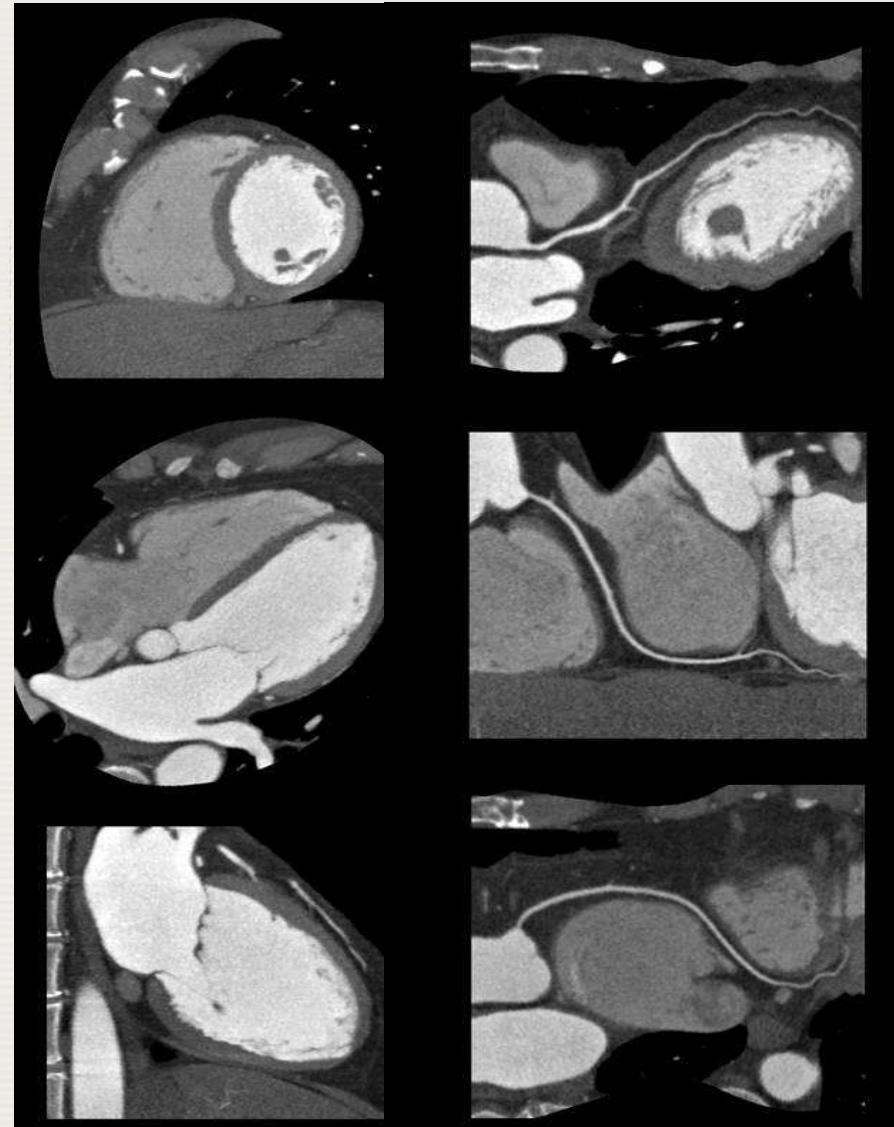

11.6 COMPUTED TOMOGRAPHY IMAGE QUALITY

11.6.4 Artefacts

- Calibration of the scanner
 - ensures optimum image quality
 - Should be carried out according to manufacturers instructions
 - Includes frequent air calibrations
 - less frequent calibrations with homogeneous water phantoms.
- Air calibrations allow for acquiring information about the small differences in the response of individual detector elements.
 - This is essential since in CT the projections have to be accurate within 0.5% and an air calibration allows for appropriate calibration and correction of the signal recorded by each individual detector element.

11.6 COMPUTED TOMOGRAPHY IMAGE QUALITY

11.6.4 Artefacts

- ☐ Calibrations with phantoms allow for (some) correction of the beam hardening effect

Example:

A calibration with a water filled phantom.

The relatively small phantom is used for calibration of acquisitions with a relatively small field of view.



11.6 COMPUTED TOMOGRAPHY IMAGE QUALITY

11.6.4 Artefacts

- Artefacts can be related to data acquisition, image reconstruction, and the patient
 - In reality there is some overlap of the definitions with many artefacts
- Data acquisition related examples
 - Ring artefact - malfunctioning of one or more detector elements
 - Unusable images from malfunctioning of the X-ray tube during the acquisition
 - Under sampling leads to Moiré patterns
 - The finite slice thickness leads to an averaging that is referred to as partial volume effect,
 - Detector afterglow may induce blurring of the image.

11.6 COMPUTED TOMOGRAPHY IMAGE QUALITY

11.6.4 Artefacts

- A ring artefact occurs in case of malfunctioning of one or more detector elements

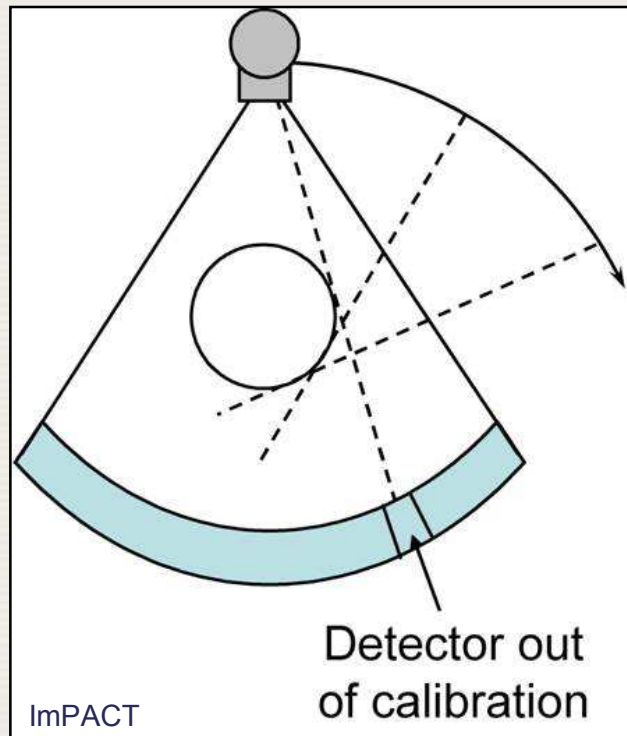

11.6 COMPUTED TOMOGRAPHY IMAGE QUALITY

11.6.4 Artefacts

- ❑ Strong attenuation of the X-ray beam by compact bone, calcifications, or a metal object may lead to a beam hardening artefact.
- ❑ Image shows typical streaks from an image of a hip prosthesis (large metal implant)

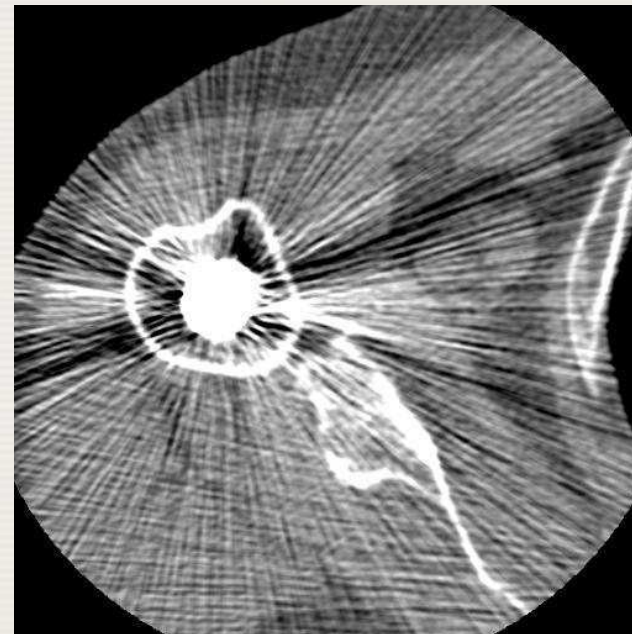

11.6 COMPUTED TOMOGRAPHY IMAGE QUALITY

11.6.4 Artefacts

- ❑ Other reconstruction related artefacts include the partial volume effect when relatively thick slices are reconstructed, the helical artefact (windmill patterns) in helical acquisitions, and the cone beam artefact (streaks).



Windmill artefact

ImPACT

11.6 COMPUTED TOMOGRAPHY IMAGE QUALITY

11.6.4 Artefacts

□ Demonstration of cone beam artefact

- Caused by non-matching opposing projections for off-axis objects

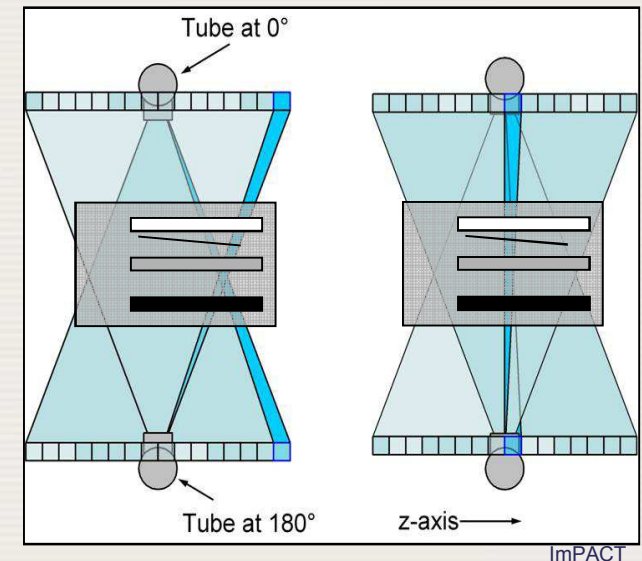
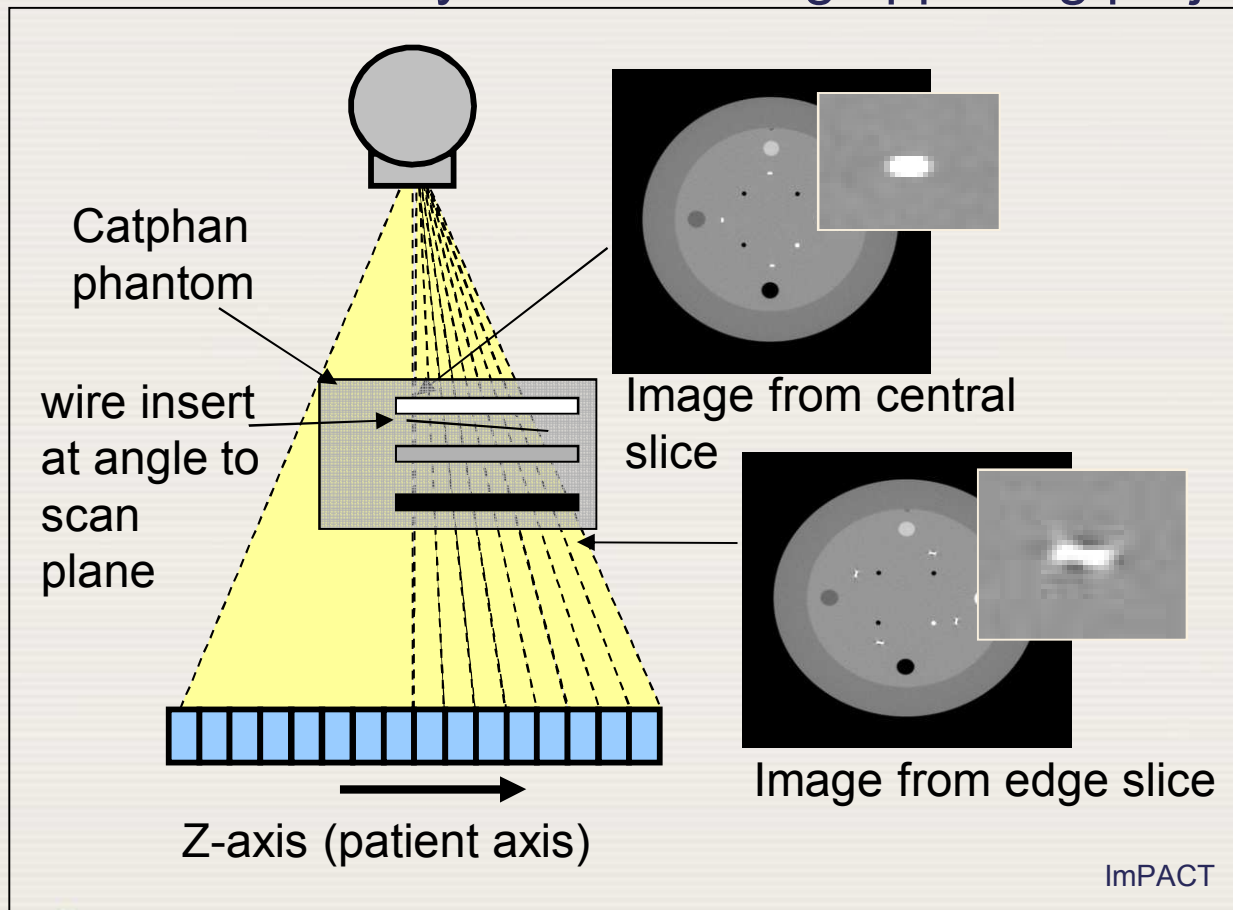

11.6 COMPUTED TOMOGRAPHY IMAGE QUALITY

11.6.4 Artefacts

- Patient related artefacts can sometimes be avoided by properly instructing the patient not to move during the scan and to maintain the breathhold during the entire scan, particularly during scans of the trunk.

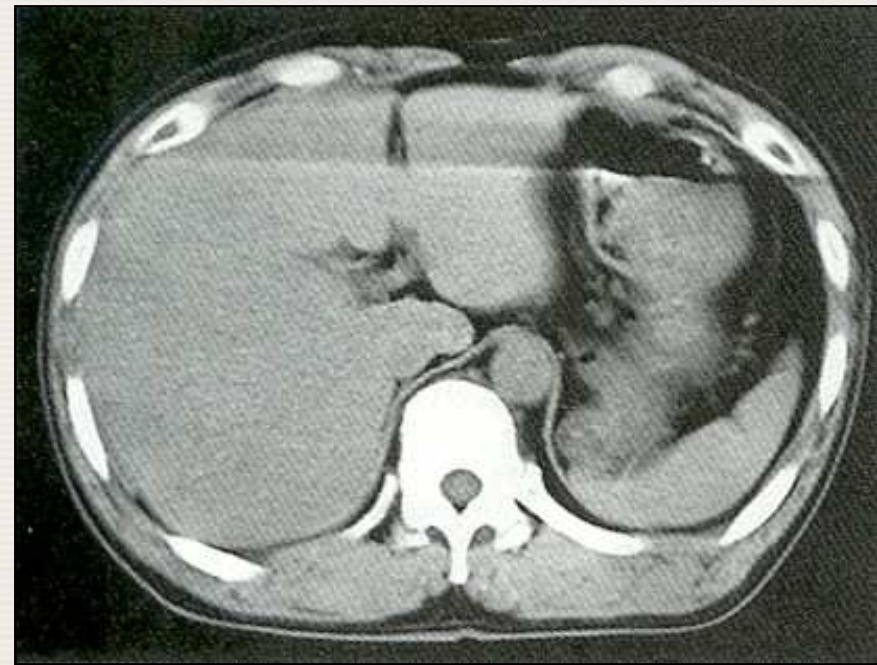

11.6 COMPUTED TOMOGRAPHY IMAGE QUALITY

11.6.4 Artefacts

- Movement of the heart and pulsation of the vessels cannot be avoided
 - acquisitions of, for example the coronary arteries or the aorta, therefore need to be optimized to achieve the best possible temporal resolution
 - pulsation of the aorta may induce artefacts that mimic an aortic dissection.

11.6 BIBLIOGRAPHY

- ❑ Buzug TM. Computed Tomography: From Photon Statistics to Modern Cone-Beam CT. ISBN 9783540394075. Springer. 2008
- ❑ Hsieh J. Computed Tomography: Principles, Design, Artifacts, and Recent Advances. SPIE Press Book. ISBN: 9780819475336. Second edition, 2009
- ❑ Kak AC, Slaney M. Principles of Computerized Tomographic Imaging, IEEE Press, 1988 (a free PDF copy is available at <http://www.slaney.org/pct/>)
- ❑ Kalender W. Computed Tomography: Fundamentals, System Technology, Image Quality, Applications. Publicis Corporate Publishing. 2005