

CONTROL SYSTEMS

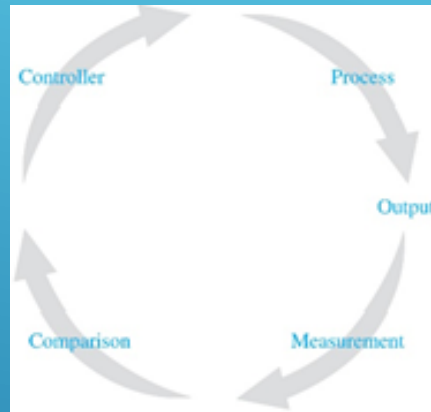

Doç. Dr. Murat Efe

WEEK 14

This week's agenda

PART 10

- **Concept of Robustness**
 - **Concept of Optimality**
 - **Concept of Adaptive Systems**
 - **Concept of Intelligence in Control**
- 

P-10 Concept of Robustness

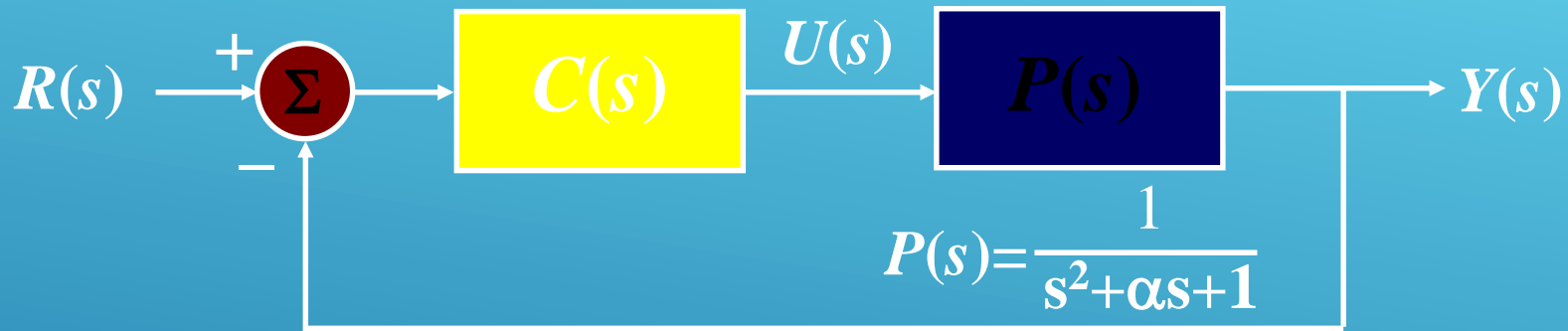

If a controller $C(s)$ meets the design specifications for every α in a known range $\alpha_{\min} \leq \alpha \leq \alpha_{\max}$ then the controller is a robust controller, and the control system is robust against variations in α .

Concept of Robustness

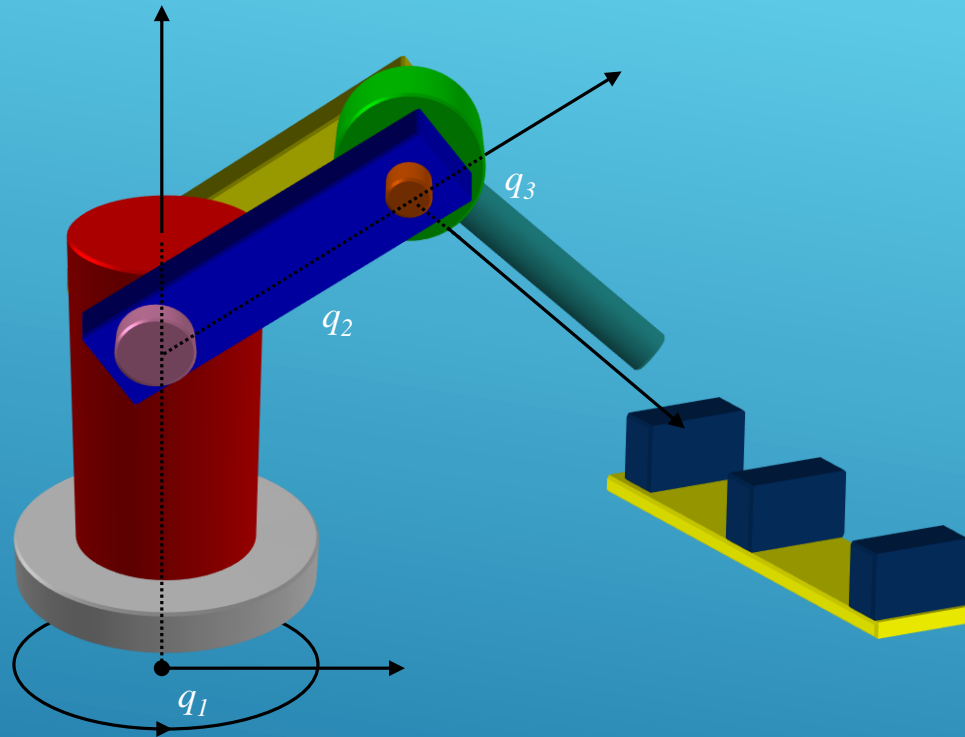

If this robot grasps a load, some parameters seen in its dynamical representation change. If a position control application is being executed, the controller must take this change into account to maintain precision.

P-10 Concept of Optimality

Limited fuel



Define a cost function letting you balance the importance of these issues, and find a way to minimize it

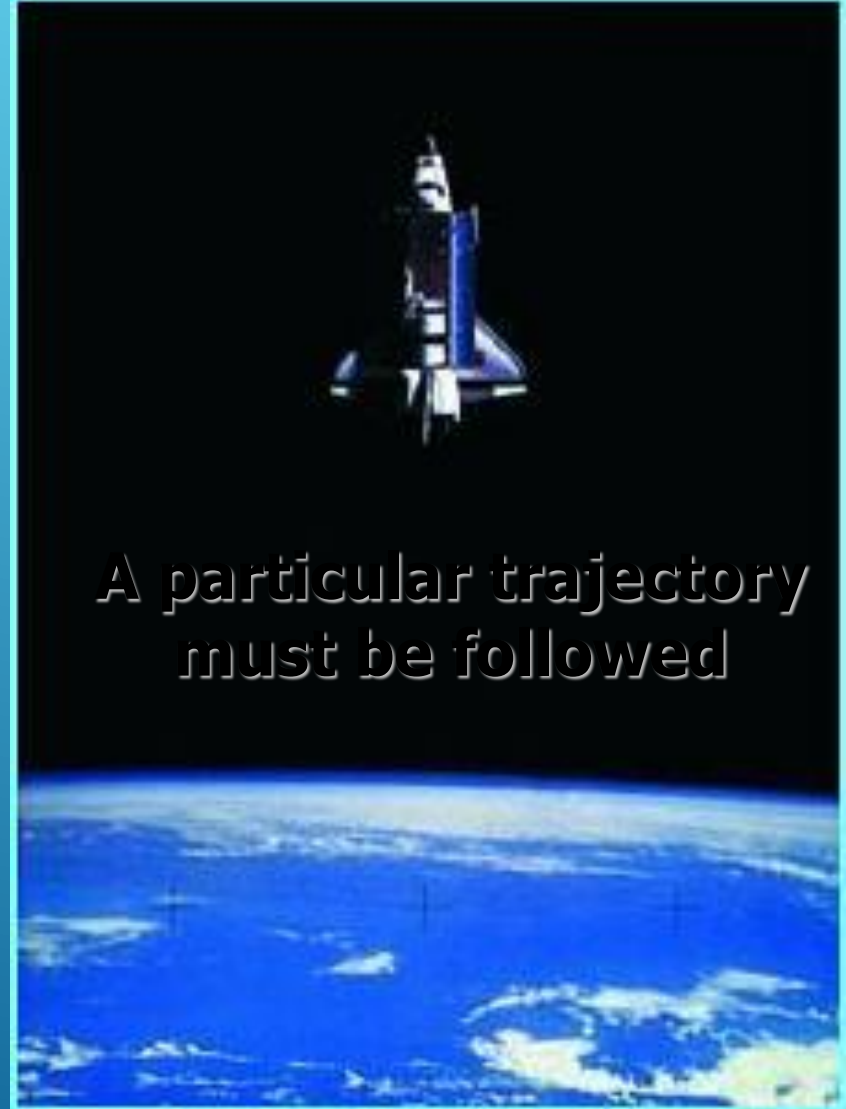

A particular trajectory must be followed

Concept of Optimality

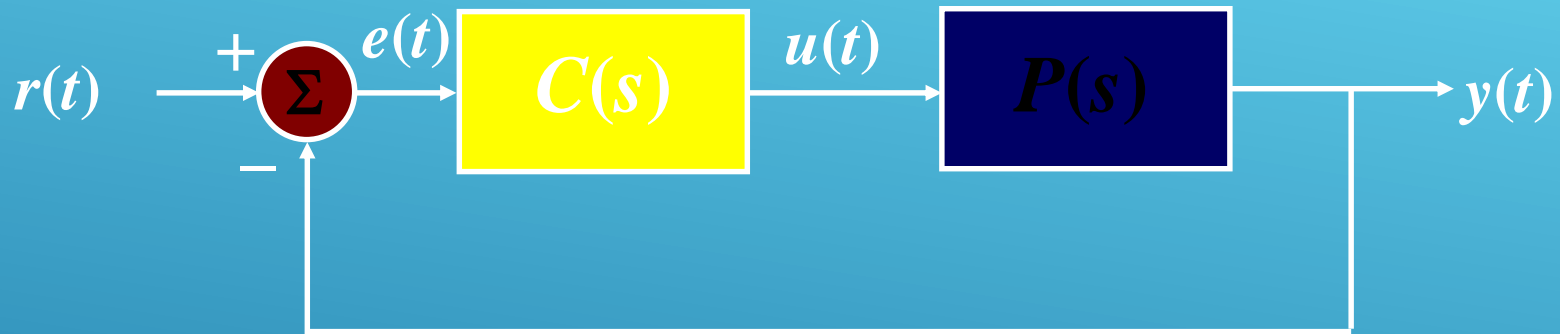

Design $C(s)$ such that $J = \frac{1}{2} \int_0^{\infty} \{e^2 + \gamma u^2 + \lambda\} dt$ is minimized

Large γ increases the relative importance of fuel consumption

Large λ increases the relative importance of time

P-10 Concept of Adaptive Systems

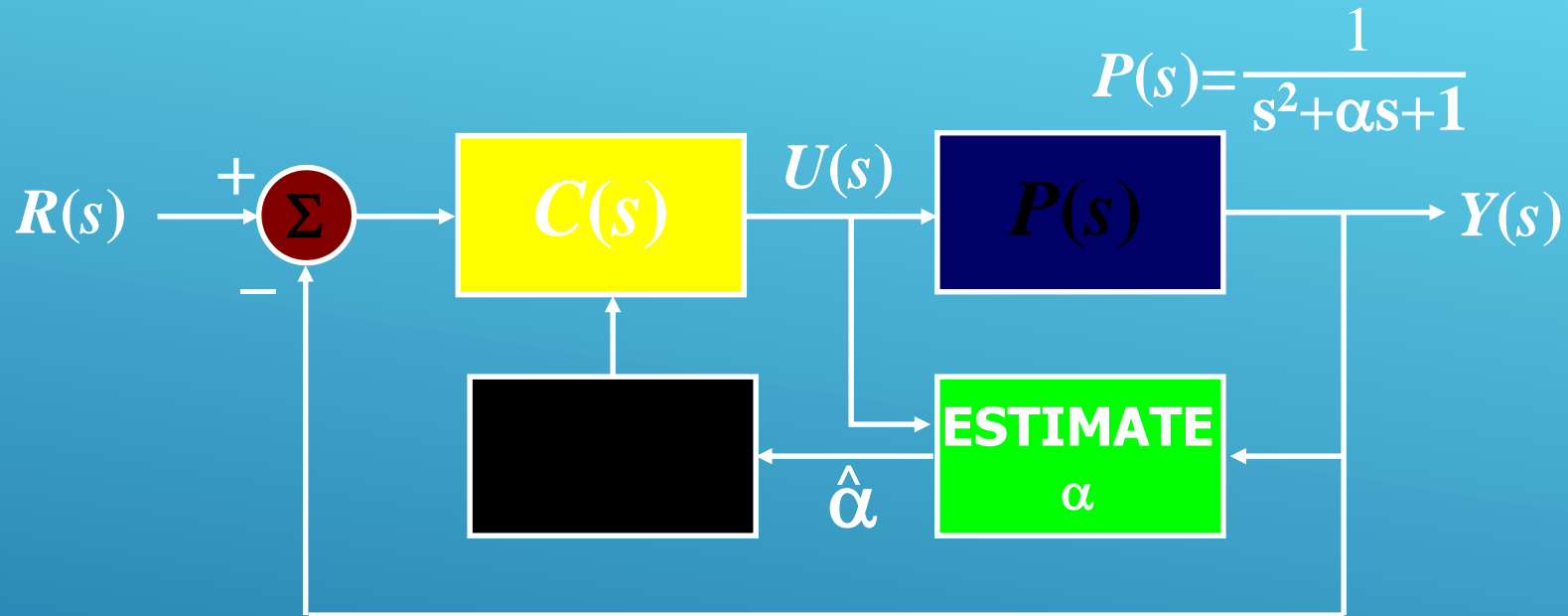

If α is unknown, we can devise an estimation scheme; and based on the estimated value $\hat{\alpha}$, we can perform the design, and operate the controller in the loop.

P-10 Concept of Intelligence in Control

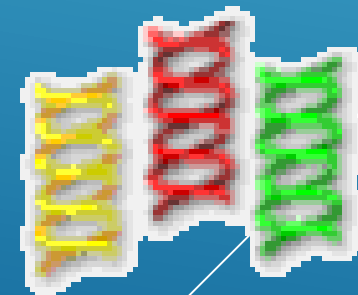
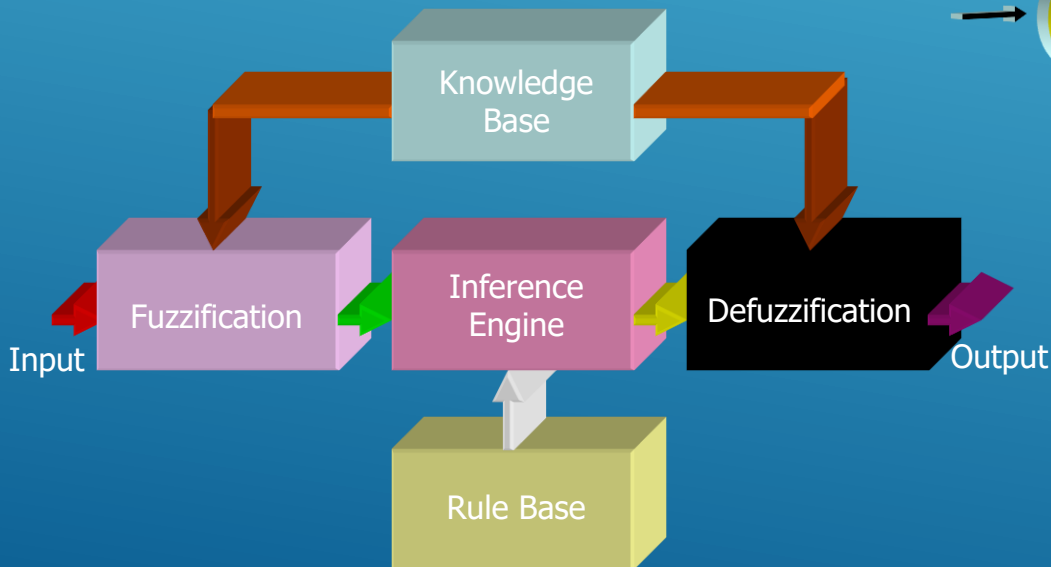
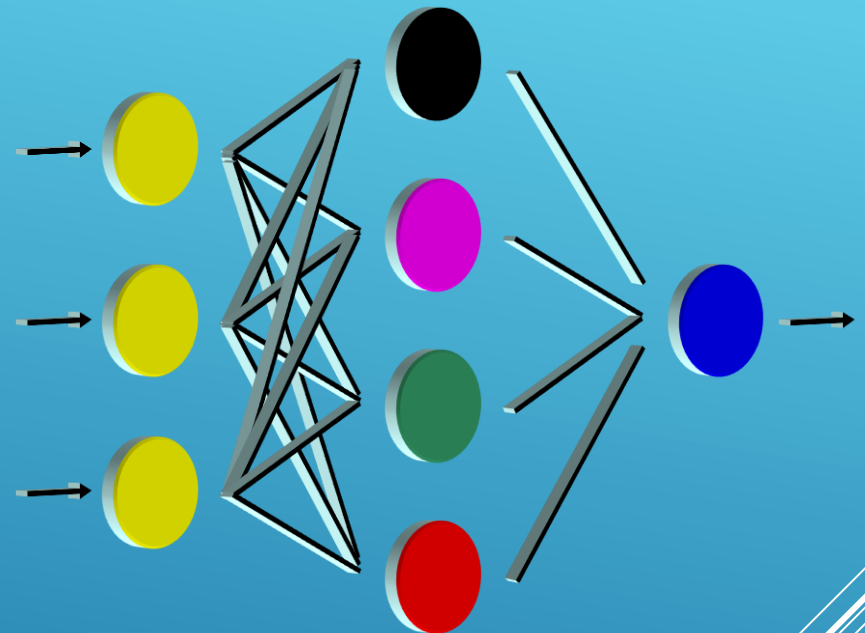
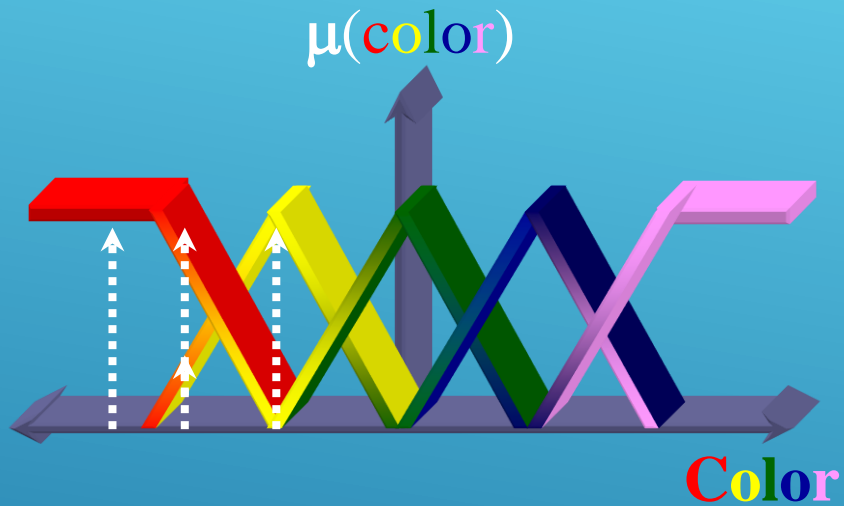

Concept of Intelligence in Control

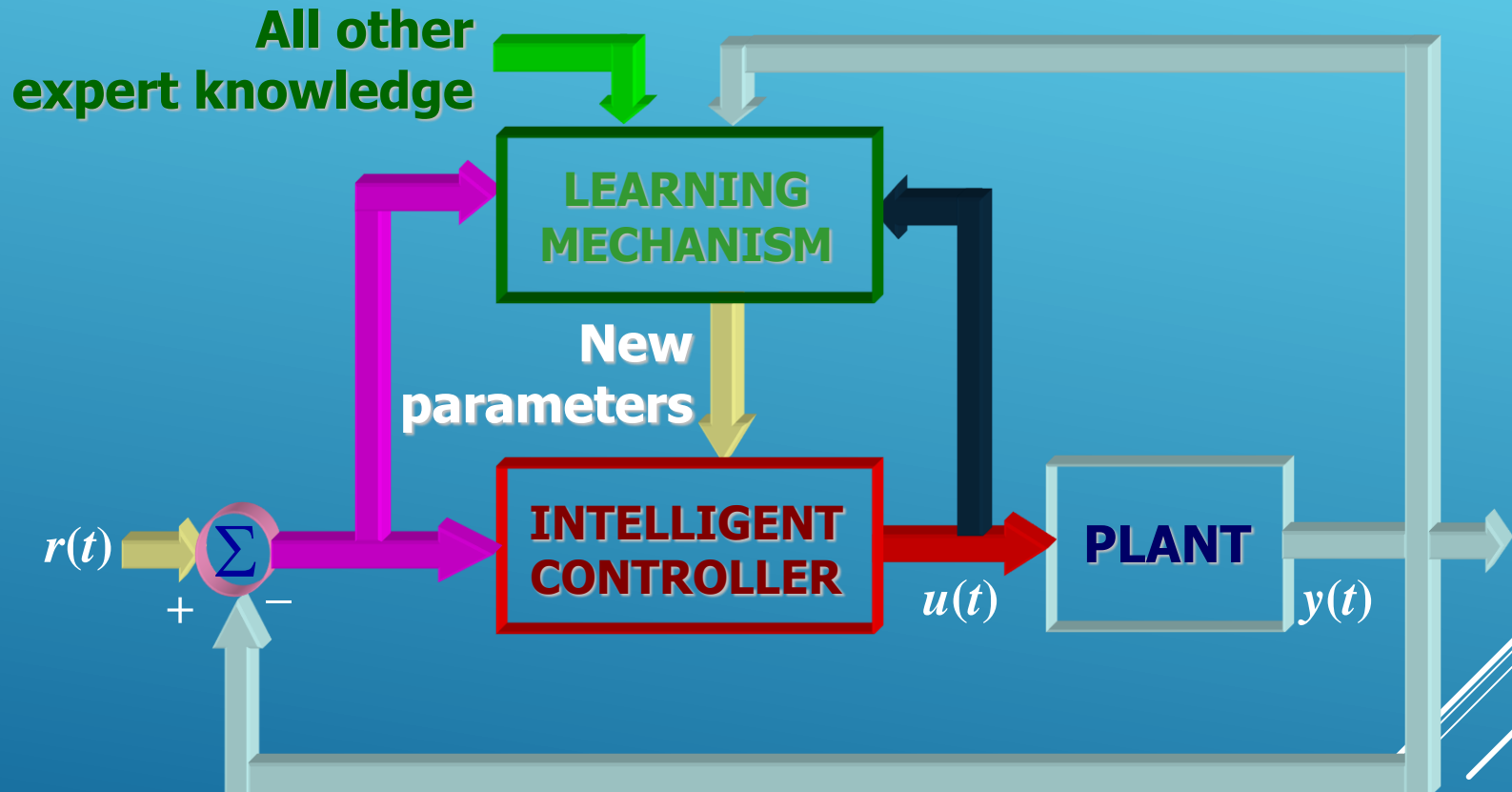

Concept of Intelligence in Control

