

FDE 330

FOOD BIOTECHNOLOGY

NUCLEIC ACIDS

Introduction

- ▶ **Deoxyribonucleic acid (DNA)** and its sister compound **ribonucleic acid (RNA)** are vital components of many biotechnological applications.
- ▶ The molecular biology revolution that has occurred in the last 20 years and created so many new biotechnological opportunities is fundamentally based on the ability to precisely manipulate DNA.
- ▶ Therefore, it is essential for biotechnologists to have a thorough understanding of DNA.

Introduction

By using structural features of DNA,

- ▶ Isolation of DNA,
- ▶ Separation of DNA strands from each other,
- ▶ Separating of DNA into various fragments and re-annealing by enzymes,
- ▶ Transferring a piece of DNA (gene) with a specific function from a cell or living organism to another organism can be achieved.

Nucleic Acids

- ▶ **Nucleic acids** are polymers made up of individual nucleotide monomers.
- ▶ They are the hereditary determinants of living organisms.
- ▶ **The nucleic acids (DNA and RNA)** are the molecular repositories for genetic information and are jointly referred to as the ‘molecules of heredity’.
- ▶ **Nucleic acids** are the most important macromolecules for the continuity of life. They carry the genetic blueprint of a cell and carry instructions for the functioning of the cell.
- ▶ The structure of every protein, and ultimately of every cell constituent, is a product of information programmed into the nucleotide sequence of a cell’s nucleic acids.

Types of Nucleic Acids (DNA&RNA)

RNA

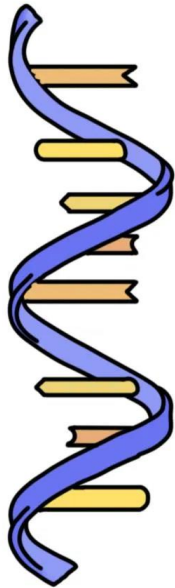

DNA

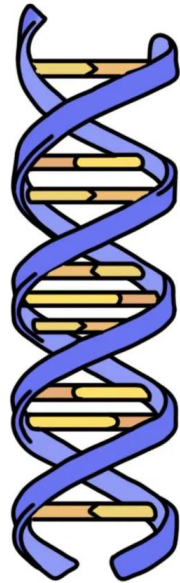

- ▶ Deoxyribonucleic acid (DNA)
- ▶ Ribonucleic acid (RNA)

Types of Nucleic Acids (DNA&RNA)

- ▶ **DNA** is found mainly in the chromatin of **the cell nucleus**.
- ▶ Most of the **RNA** (90%) is present in **the cell cytoplasm** and a little (10%) in the nucleus.
- ▶ It may be added that **extranuclear DNA** also exists; it occurs, for example, **in mitochondria and chloroplasts**.

Structure of Nucleic Acids

- ▶ Nucleic acids are **polynucleotides**.
- ▶ Nucleic acids are long chainlike molecules composed of a series of nearly identical building blocks called **nucleotides**.
- ▶ Each nucleotide consists of a **nitrogen-containing aromatic base** attached to a **pentose (five-carbon) sugar**, which is in turn attached to a **phosphate group**.
- ▶ The molecule without a phosphate group is called a **nucleoside**. Without an attached phosphate group, the sugar attached to one of the bases is known as a **nucleoside**.

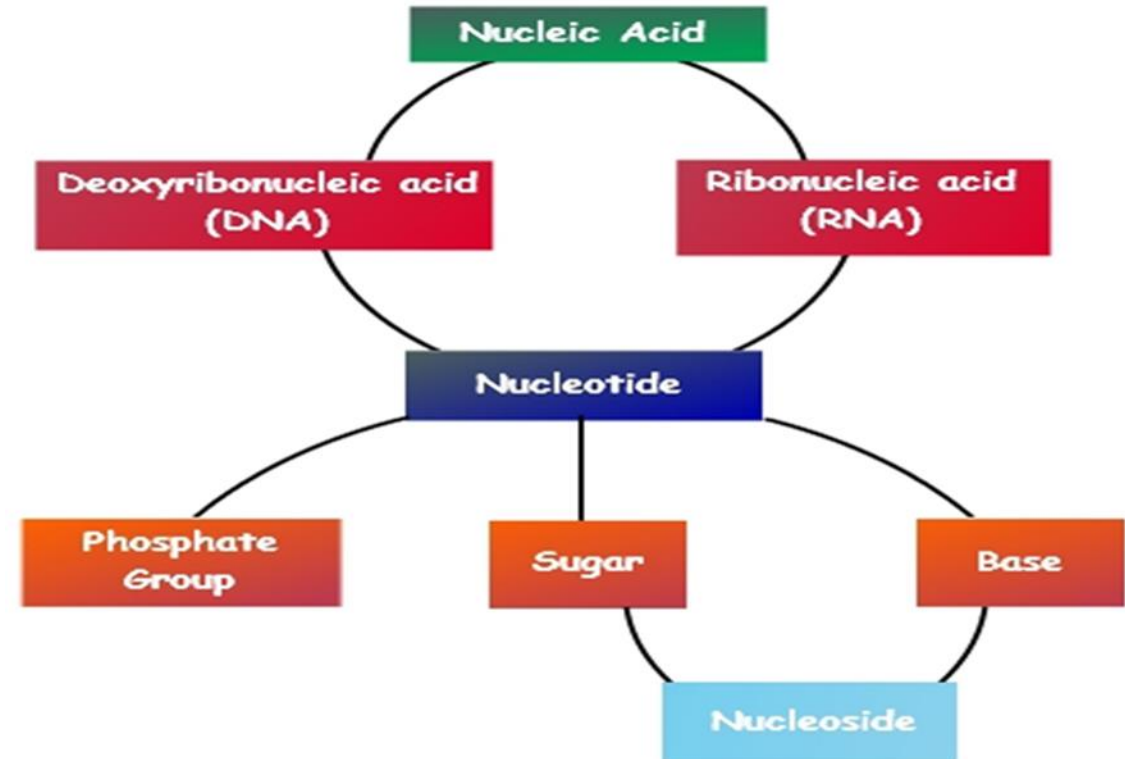

Nucleotides: Building Blocks of Nucleic Acids

- ▶ DNA and RNA are made up of monomers known as nucleotides.
- ▶ DNA contains deoxynucleotides and RNA contains ribonucleotides.
- ▶ The nucleotides combine with each other to form a polynucleotide: DNA or RNA.
- ▶ A nucleotide has three characteristic components:
 1. **a nitrogenous (nitrogen-containing) base**
 2. **a pentose (five-carbon) sugar**
 3. **one or more phosphates**
- ▶ Each nitrogenous base in a nucleotide is attached to a sugar molecule, which is attached to one or more phosphate groups.

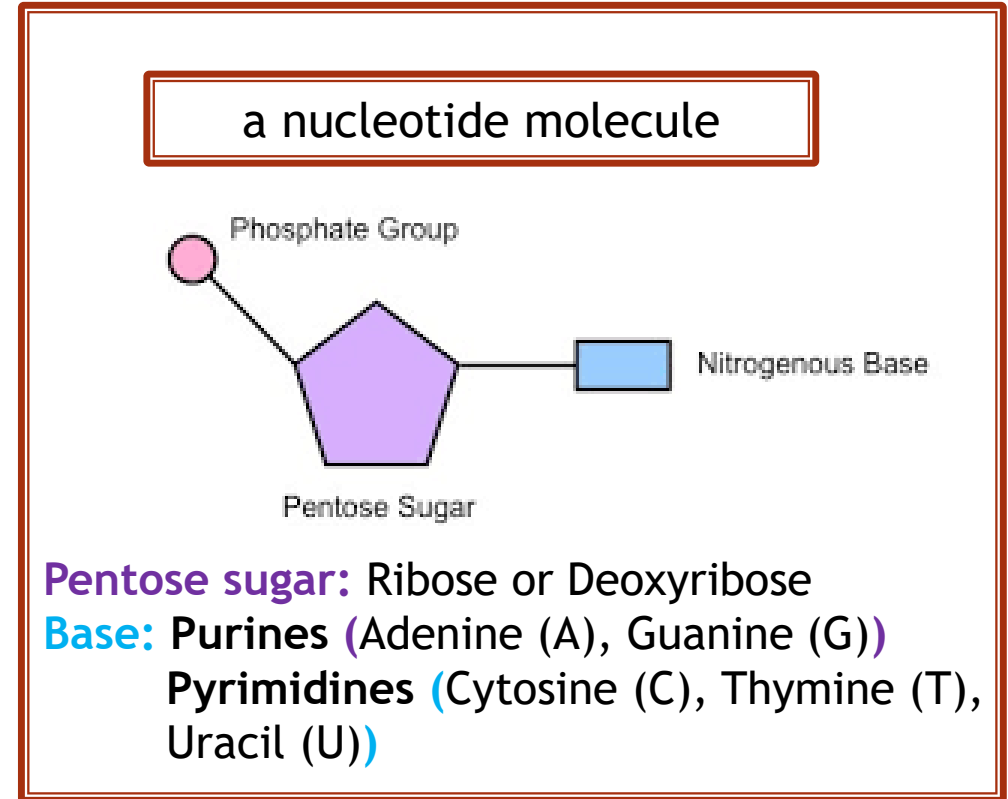

Structure of Nucleotides

- ▶ The nitrogenous bases are derivatives of two parent compounds, **pyrimidine and purine**.
- ▶ The bases and pentoses of the common nucleotides are heterocyclic compounds.
- ▶ Carbon and nitrogen atoms on the nitrogenous base are numbered in cyclic format.
- ▶ In the pentoses of nucleotides and nucleosides the carbon numbers are given a prime (') designation to distinguish them from the numbered atoms of the nitrogenous bases.

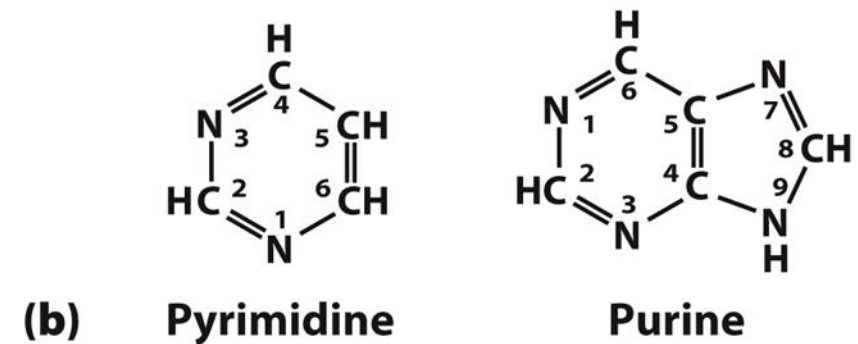
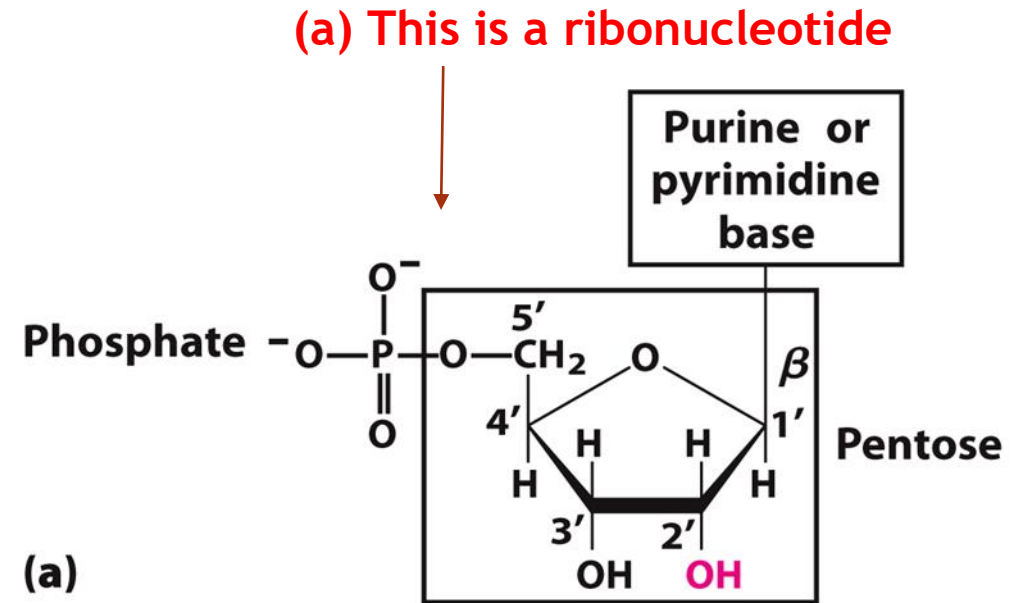
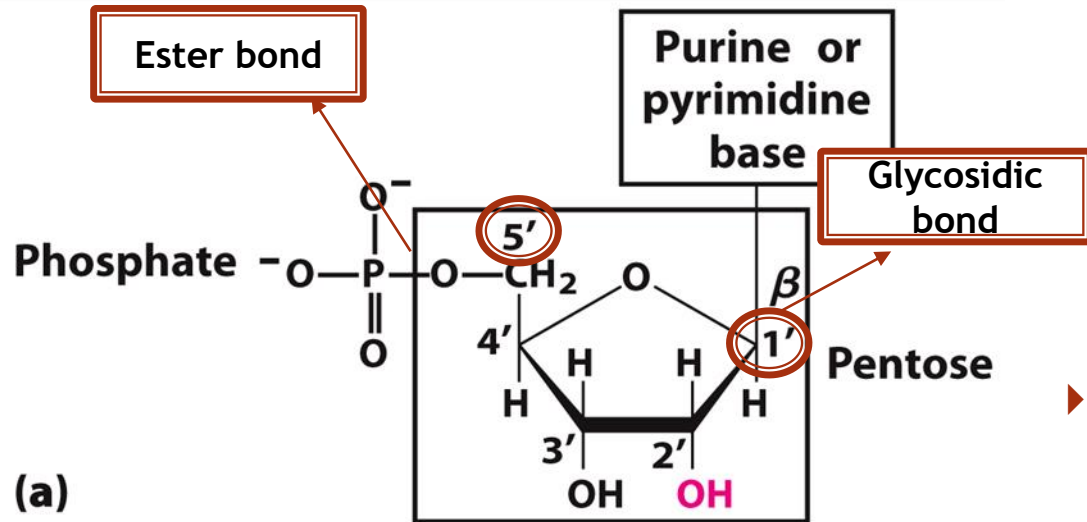

Figure 8-1
Lehninger Principles of Biochemistry, Seventh Edition
© 2017 W. H. Freeman and Company

- ✓ The aromatic base atoms are numbered 1 through 9 for purines and 1 through 6 for pyrimidines.
- ✓ The ribose sugar is numbered 1' through 5'.

(a) This is a ribonucleotide



(a)

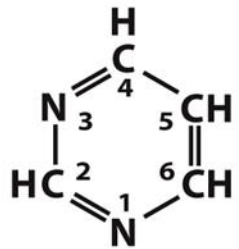

(b) Pyrimidine

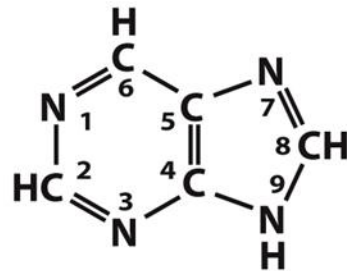

Purine

- ▶ The base of a nucleotide is joined covalently (at N-1 of pyrimidines and N-9 of purines) in an ***N-β-glycosyl bond*** to **the 1' carbon of the pentose**, and **the phosphate is esterified to the 5' carbon**.
- ▶ The *N-β-glycosyl bond* is formed by removal of the elements of water (a hydroxyl group from the pentose and hydrogen from the base), as in *O-glycosidic bond* formation.

Covalent bonds

- ✓ There is **glycosidic bond** between the bases (the 9' nitrogen of purine bases or 1' nitrogen of pyrimidine bases) and the sugar group (the 1' carbon of the sugar group).
- ✓ There is **ester bond** between the sugar group (the 1' carbon of the sugar group) and the phosphate group.

Figure 8-1
Lehninger Principles of Biochemistry, Seventh Edition
© 2017 W. H. Freeman and Company

»» **Key Convention:** Although DNA and RNA seem to have two distinguishing features—different pentoses and the presence of uracil in RNA and thymine in **DNA—it is the pentoses that uniquely define the identity of a nucleic acid.** If the nucleic acid contains 2'-deoxy-D-ribose, it is DNA by definition, even if it contains uracil. Similarly, if the nucleic acid contains D-ribose, it is RNA, regardless of its base composition. ‹‹

Structural Components of DNA and RNA

<i>Components</i>	<i>Ribonucleic acid</i>	<i>Deoxyribonucleic acid</i>
Acid	Phosphoric acid	Phosphoric acid
Pentose sugar	D-ribose	D-2-deoxyribose
Nitrogenous bases		
Purines	Adenine	Adenine
	Guanine	Guanine
Pyrimidines	Cytosine	Cytosine
	Uracil	Thymine

Phosphodiester Bonds Link Nucleotides Together in Nucleic Acids

- ▶ The covalent bond that links nucleotides in the sugar-phosphate backbone is a phosphodiester bond.
- ▶ The successive nucleotides of both DNA and RNA are covalently linked through phosphate-group “bridges,” in which the 5'-phosphate group of one nucleotide unit is joined to the 3'-hydroxyl group of the next nucleotide, creating a **phosphodiester linkage**.
- ▶ The phosphate residue is attached to the hydroxyl group of the 5' carbon of one sugar and the hydroxyl group of the 3' carbon of the sugar of the next nucleotide, which forms a **5'-3' phosphodiester linkage**.
- ▶ A polynucleotide may have thousands of such phosphodiester linkages.

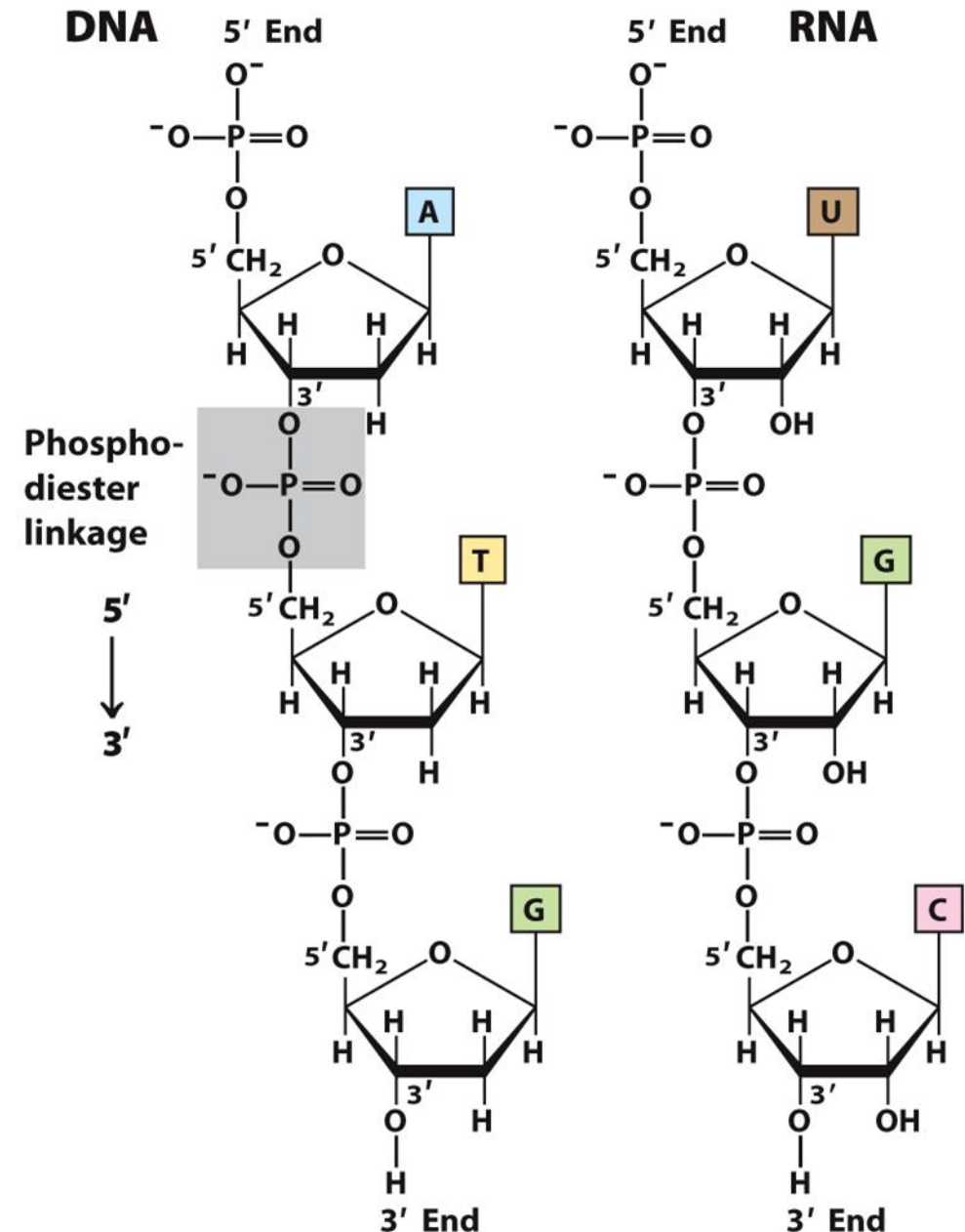
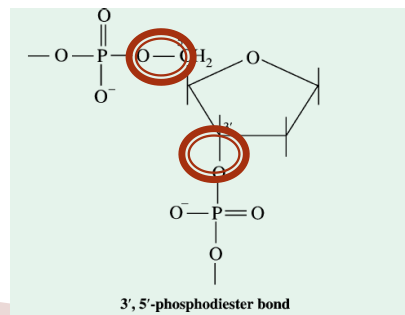
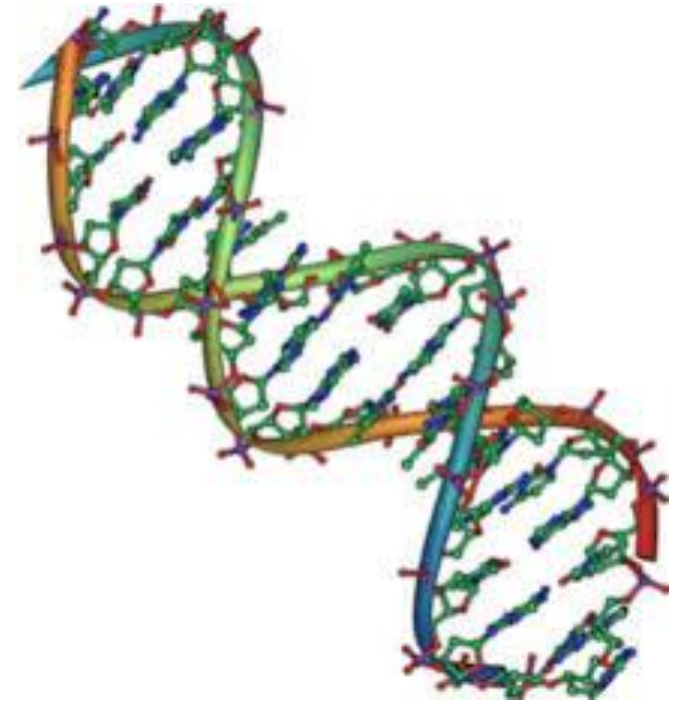

Figure 8-7

Lehninger Principles of Biochemistry, Seventh Edition
© 2017 W. H. Freeman and Company

Double Helix Structure of DNA

- ▶ DNA has a **double-helix structure**. A DNA molecule consists of two strands that wind around each other like a twisted ladder.
- ▶ The sugar and phosphate lie on the outside of the helix, forming the backbone of the DNA.
- ▶ The nitrogenous bases are stacked in the interior in pairs, like the steps of a staircase.
- ▶ The pairs are bound to each other by **hydrogen bonds**. (Every base pair in the double helix is separated from the next base pair by 0.34 nm).
- ▶ The two strands of the helix run in opposite directions, meaning that the 5' carbon end of one strand will face the 3' carbon end of its matching strand. (This is referred to as antiparallel orientation and is important to DNA replication and in many nucleic acid interactions).



- DNA is an antiparallel double helix.
- The phosphate backbone (the curvy lines) is on the outside, and the bases are on the inside.
- Each base interacts with a base from the opposing strand.

Double Helix Structure of DNA

(A DNA Molecule Consists of Two Complementary Chains of Nucleotides)

- ▶ A deoxyribonucleic acid (DNA) molecule consists of two long polynucleotide chains composed of four types of nucleotide subunits.
- ▶ Each of these chains is known as a **DNA chain**, or a **DNA strand**.
- ▶ The chains run antiparallel to each other, and *hydrogen bonds* between the base portions of the nucleotides hold the two chains together.

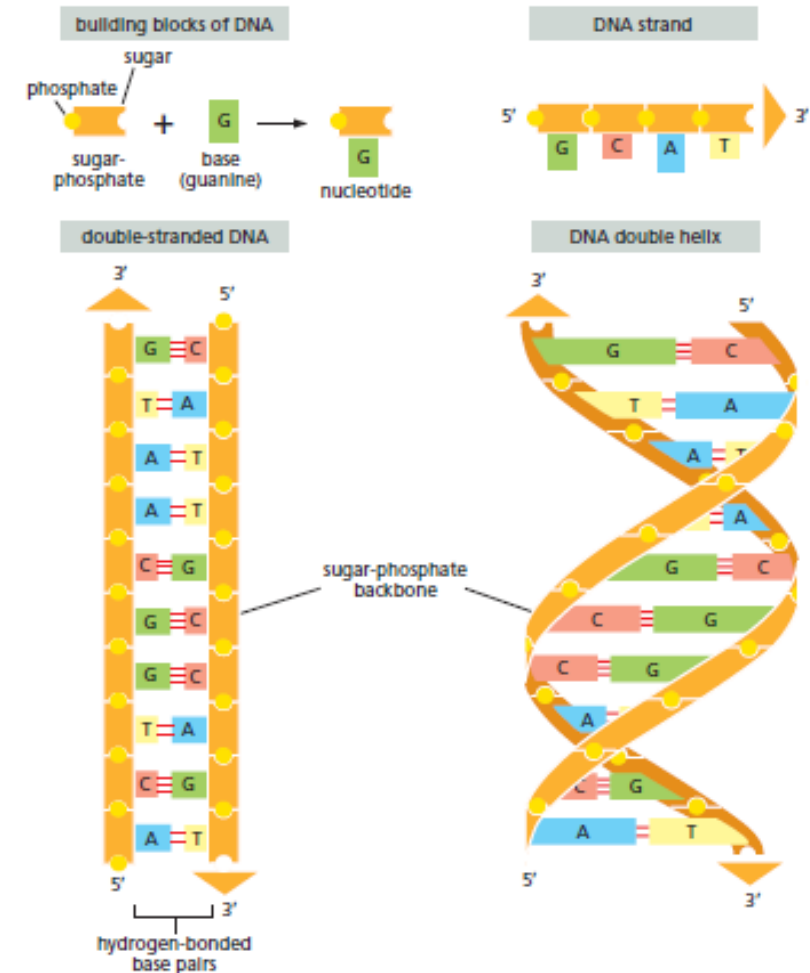

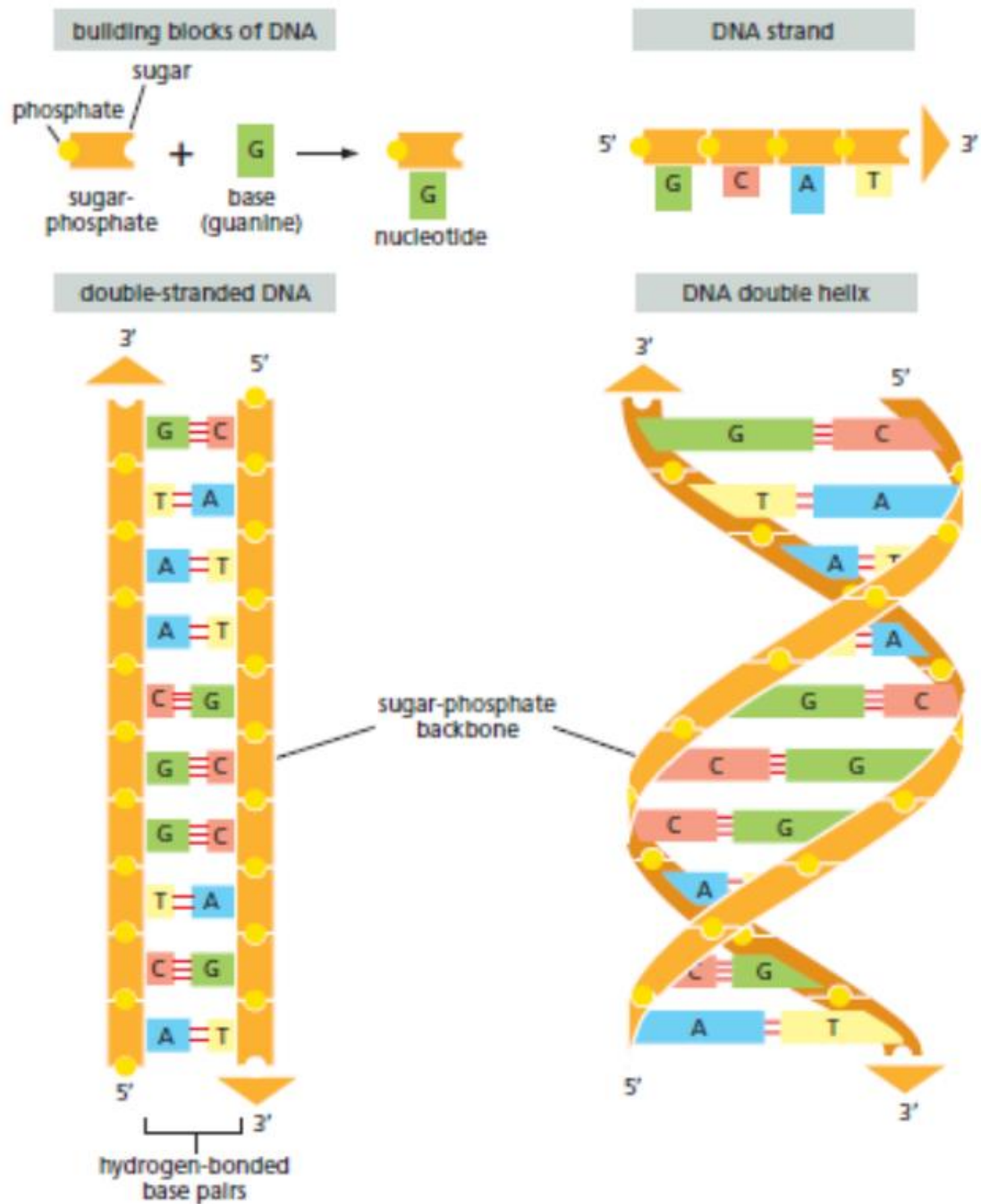

- DNA is made of four types of nucleotides, which are linked covalently into a polynucleotide chain (**a DNA strand**) with a sugar-phosphate backbone from which the bases (A, C, G, and T) extend.
- A DNA molecule is composed of **two antiparallel DNA strands** held together by hydrogen bonds between the paired bases. The *arrowheads* at the ends of the DNA strands indicate the polarities of the two strands.
- In the diagram at the bottom left of the figure, the DNA molecule is shown straightened out; in reality, it is twisted into a double helix, as shown on the right.

Base Pairs (Hydrogen Bonding Interactions)

- ▶ Two bases can hydrogen bond to form a base pair.
- ▶ Each base interacts with a base from the opposing strand.
- ▶ Only certain types of base pairing are allowed. For example, a certain purine can only pair with a certain pyrimidine. This means A can pair with T, and G can pair with C. This is known as the **base complementary rule**.
- ▶ In other words, the DNA strands are complementary to each other. If the sequence of one strand is AATTGGCC, the complementary strand would have the sequence TTAACCGG.
- ▶ During DNA replication, each strand is copied, resulting in a daughter DNA double helix containing one parental DNA strand and a newly synthesized strand.
- ▶ Three hydrogen bonds can form between G and C, symbolized **G≡C**, but only two can form between A and T, symbolized **A=T**.

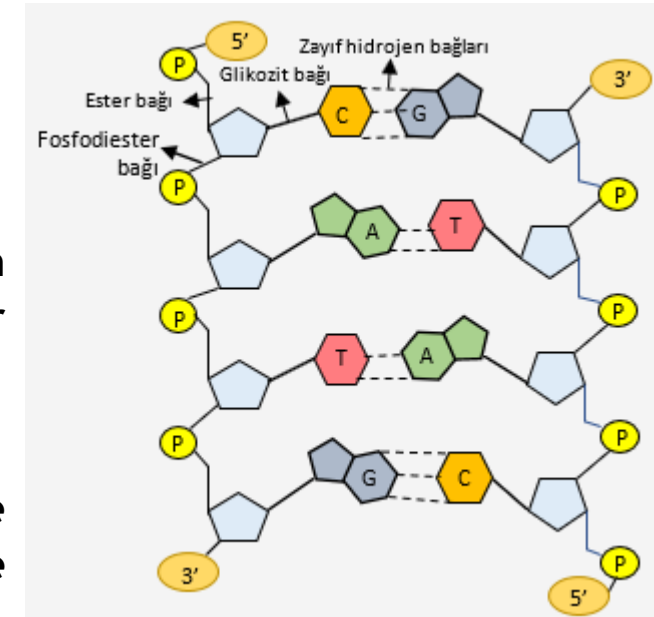

AT and GC Base Pairs

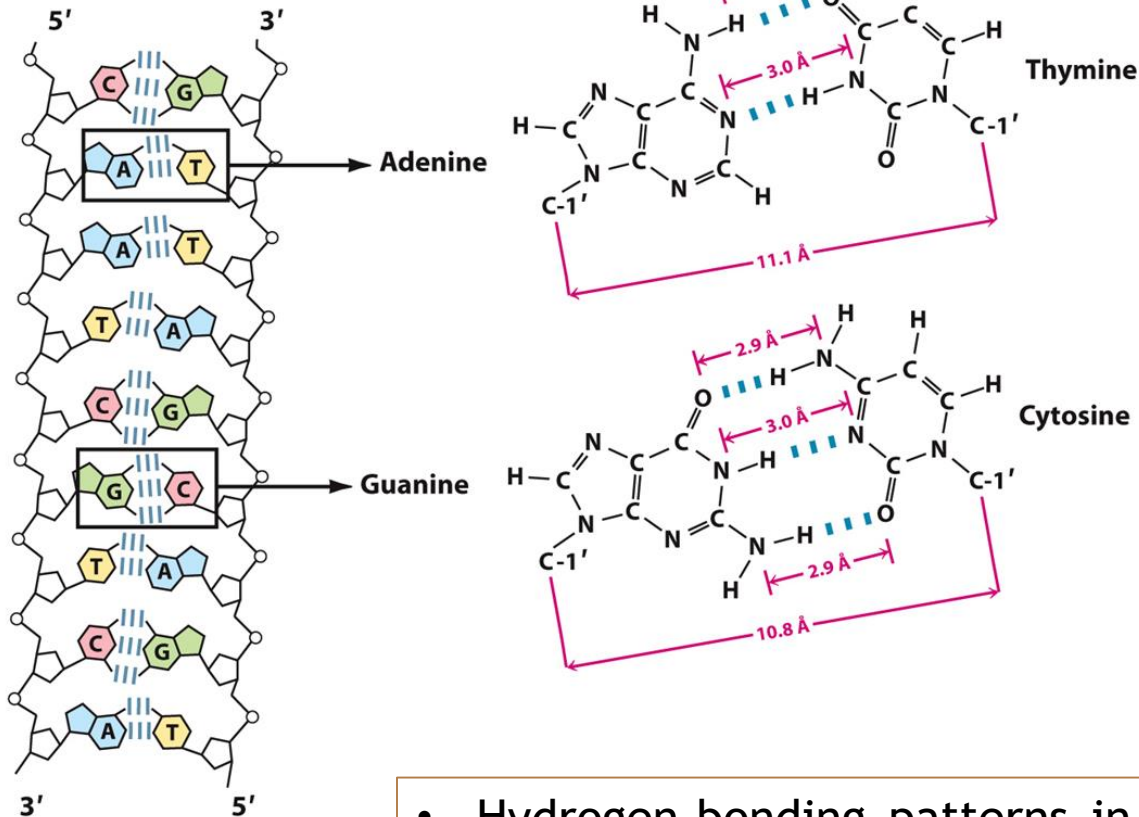
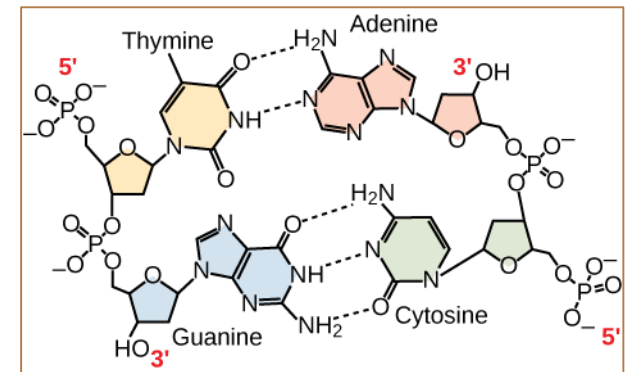

Figure 8-11
Lehninger Principles of Biochemistry, Seventh Edition
© 2017 W. H. Freeman and Company

- Hydrogen-bonding patterns in the base pairs defined by Watson and Crick.
- Hydrogen bonds are represented by three blue lines.



- In a double stranded DNA molecule, the two strands run antiparallel to one another so that one strand runs 5' to 3' and the other 3' to 5'.
- The phosphate backbone is located on the outside, and the bases are in the middle.
- **Adenine** forms hydrogen bonds (or base pairs) with **thymine**, and **guanine** base pairs with **cytosine**.

Chargaff's rules

1. The base composition of DNA generally varies from one species to another.
2. DNA specimens isolated from different tissues of the same species have the same base composition.
3. The base composition of DNA in a given species does not change with an organism's age, nutritional state, or changing environment.
4. In all cellular DNAs, regardless of the species, the number of adenosine residues is equal to the number of thymidine residues (that is, $A = T$), and the number of guanosine residues is equal to the number of cytidine residues ($G = C$). From these relationships it follows that the sum of the purine residues equals the sum of the pyrimidine residues; that is, $A + G = T + C$.

Three-dimensional structure of DNA-DNA Double Helix

- ▶ **The three-dimensional structure of DNA—the DNA double helix**—arises from the chemical and structural features of its two polynucleotide chains.
- ▶ Putting together the available data, Watson and Crick postulated that native DNA consists of two antiparallel chains in a right-handed double-helical arrangement. Complementary base pairs, A=T and G≡C, are formed by hydrogen bonding within the helix. The base pairs are stacked perpendicular to the long axis of the double helix, 3.4 Å apart, with 10.5 base pairs per turn.
- ▶ DNA can exist in several structural forms. Two variations of the Watson Crick form, or B-DNA, are A- and Z-DNA. Some sequence-dependent structural variations cause bends in the DNA molecule. DNA strands with appropriate sequences can form hairpin or cruciform structures or triplex or tetraplex DNA.

Watson-Crick Model of B-DNA

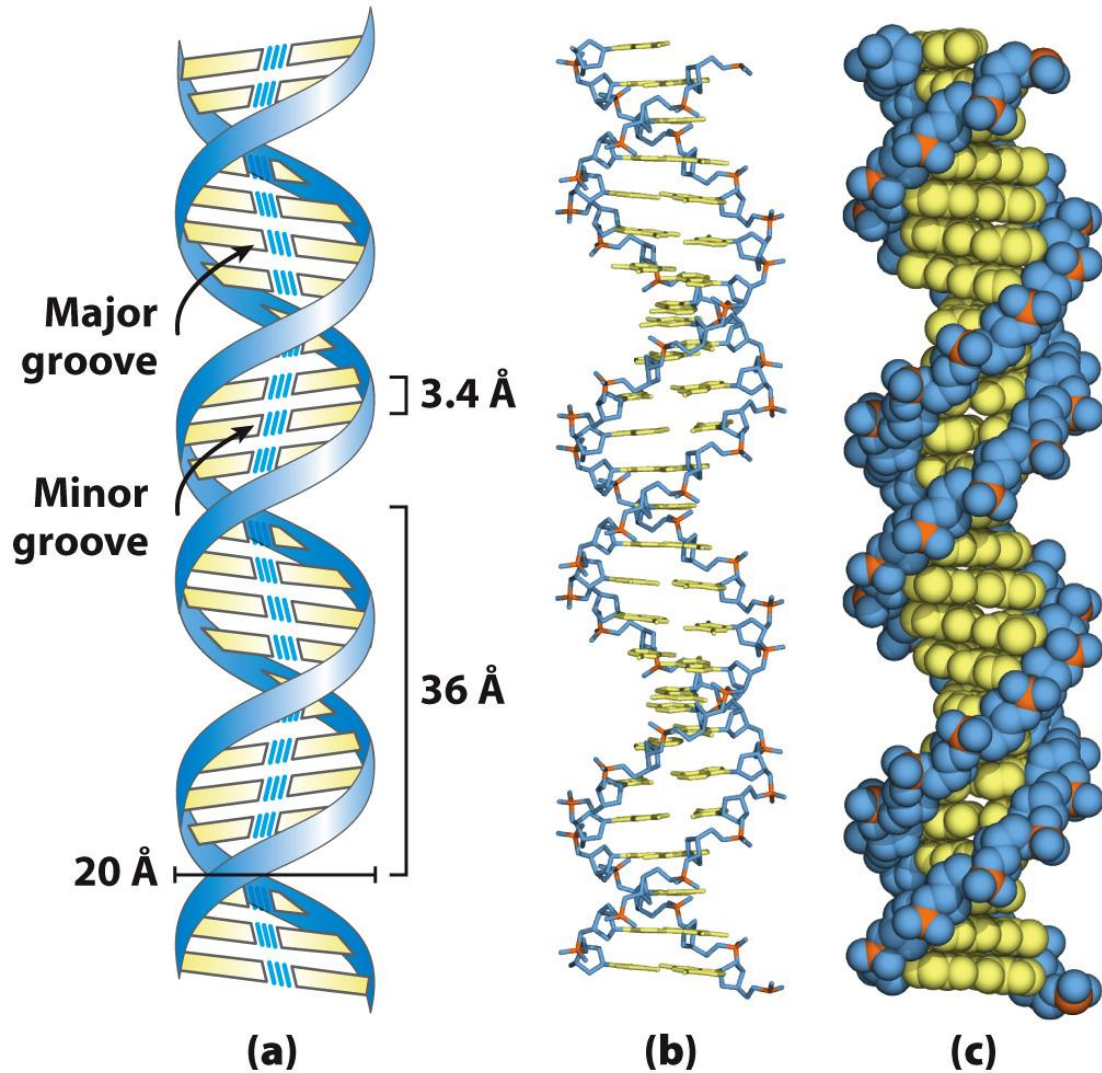

Watson-Crick model for the structure of DNA.

The original model proposed by Watson and Crick had 10 base pairs, or 34 Å (3.4 nm), per turn of the helix; subsequent measurements revealed 10.5 base pairs, or 36 Å (3.6 nm), per turn.

- (a) Schematic representation, showing dimensions of the helix.
- (b) Stick representation showing the backbone and stacking of the bases.
- (c) Space-filling model.

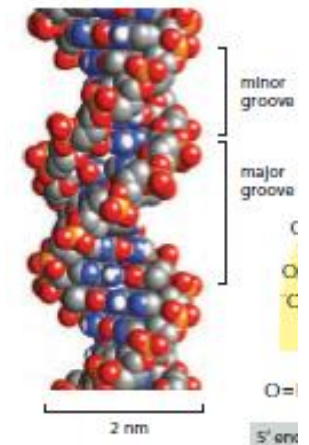

The coiling of the two strands around each other creates two grooves in the double helix: the wider groove is called the **major groove**, and the smaller the **minor groove**.

DNA Denaturation

- ▶ Covalent bonds remain intact.
 - Genetic code remains intact.
- ▶ Hydrogen bonds are broken.
 - Two strands separate.
- ▶ Base stacking is lost
 - UV absorbance increases.

Denaturation can be induced by high temperature, or change in pH.

Denaturation may be reversible:
annealing.

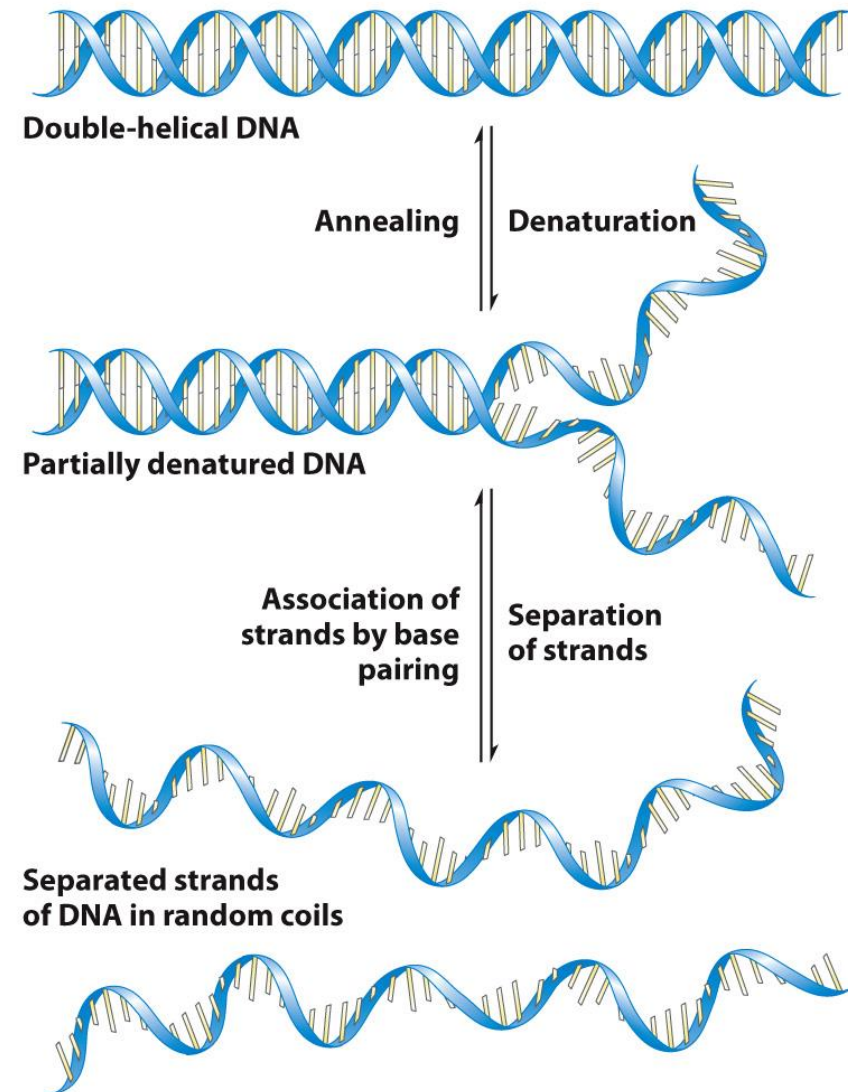

Figure 8-26
Lehninger Principles of Biochemistry, Seventh Edition
© 2017 W. H. Freeman and Company

Thermal DNA Denaturation (Melting)

- ▶ DNA exists as double helix at normal temperatures.
- ▶ Two DNA strands dissociate at elevated temperatures.
- ▶ Two strands re-anneal when the temperature is lowered.
- ▶ The reversible thermal denaturation and annealing form the **basis for the polymerase chain reaction**.
- ▶ DNA denaturation is commonly monitored by **UV spectrophotometry at 260 nm**.

Ribonucleic Acid (RNA)

- ▶ **Ribonucleic acid (RNA)**, like DNA, is a long, unbranched macromolecule consisting of nucleotides joined by 3' → 5' phosphodiester bonds.
- ▶ The number of ribonucleotides in RNA ranges from as few as 75 to many thousands.
- ▶ Ribonucleic acid, or RNA, is mainly involved in the process of protein synthesis under the direction of DNA.
- ▶ RNA is usually single-stranded and is made of ribonucleotides that are linked by phosphodiester bonds. However, RNA can be structurally complex; single RNA strands can fold into hairpins, double-stranded regions, or complex loops.
- ▶ A ribonucleotide in the RNA chain contains ribose (the pentose sugar), one of the four nitrogenous bases (A, U, G, and C), and the phosphate group.

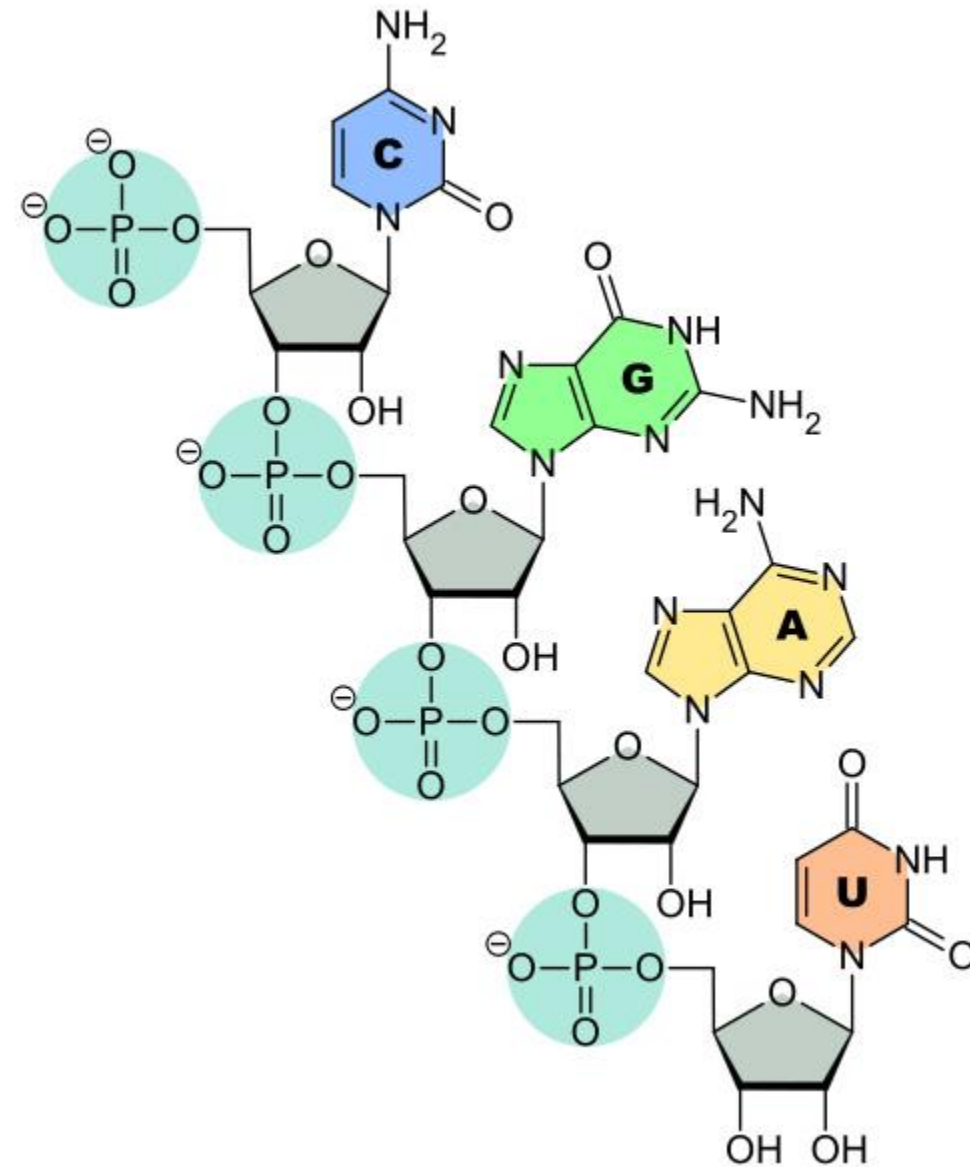

Comparison Between DNA and RNA

RNA vs DNA

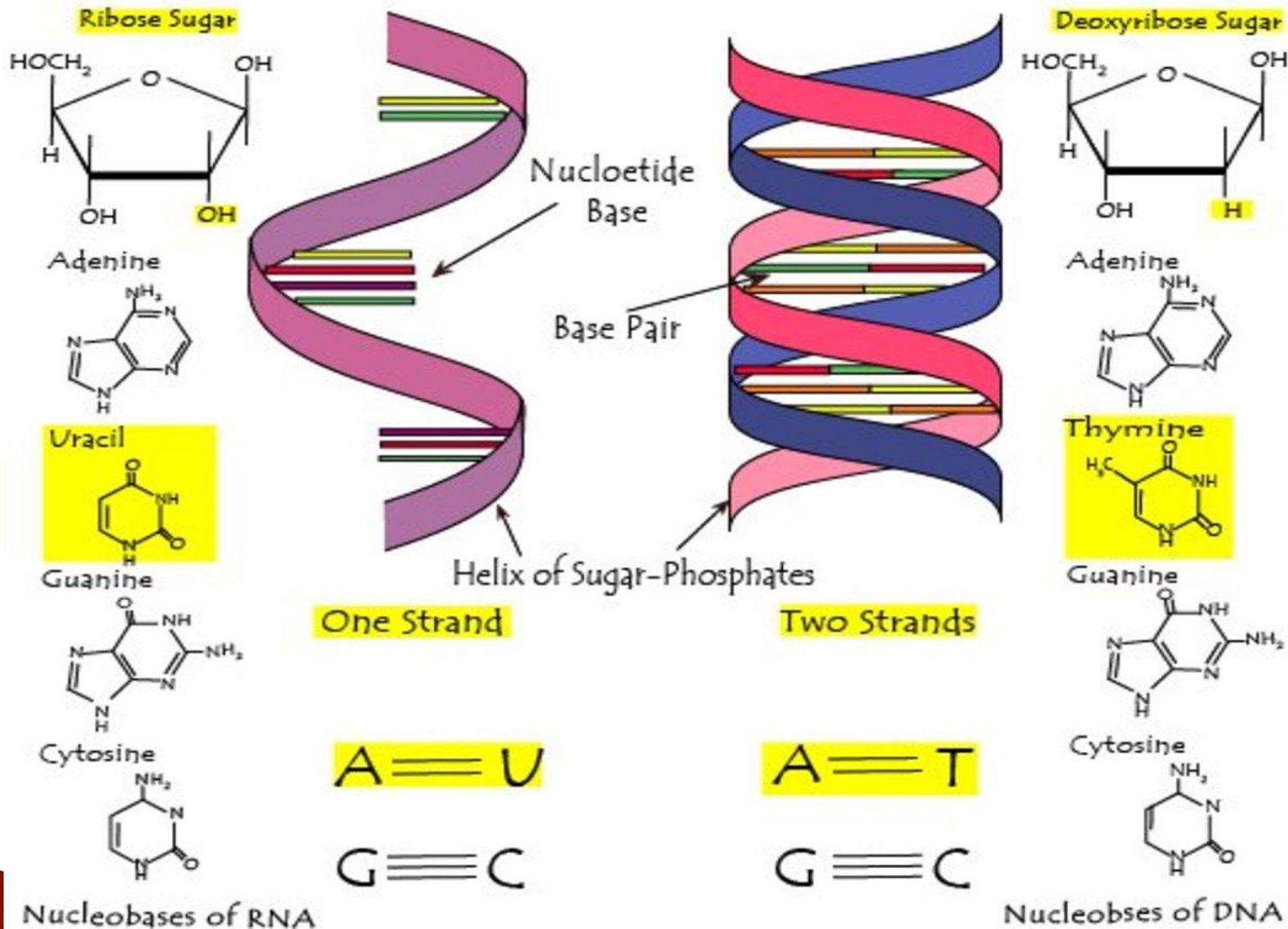

- ✓ In addition, Chargaff's rules are applicable only for double stranded DNA molecule. These are not applicable for single stranded DNA or RNA molecules. This is because in a ds DNA molecule, complementary base pairing occurs between A and T, and C and G base pairs. This complementary base pairing is not possible in case of single stranded RNA molecule. Thus, Chargaff's rules are not applicable to RNA.
- ✓ Although the DNA molecule is the source of genetic information, the RNA molecule plays a role in the expression of this genetic information, namely protein synthesis.