

# **9. BÖLÜM**

## **HALAF YERLEŐİMLERİ**

## HALAF YERLEŞİMLERİNİN YAYILIMI

Halaf kültürü yaşadığı sürece Bugünkü Suriye'nin tamamı, Kuzey Mezopotamya kapsayan bir Alana yayıldı. Ayrıca Güney Doğu Anadolu bölgesinin büyük kısmında varlığını gösterdi. Etkileri Zağros eteklerine kadar uzandı. Bu yayımda karşımıza çıkan en karakteristik özellik Tholos olarak tanımlanan uzun koridorlu (dromos) yapılardır. Bu tür yapılara Yukarı Fırat'ta yer alan Kargamış çevresinden Irak-İran sınırı çevresindeki görülmüştür. Hamrin Havzası'na kadar olan alanda bu tarz yapılar görülmüştür. Bu tarz yapı formu Halaf kültürüne özgüdür. Bu tür yapılar Güney Doğu Anadolu'nun kuzeyine doğru olan bölgede azaldı.

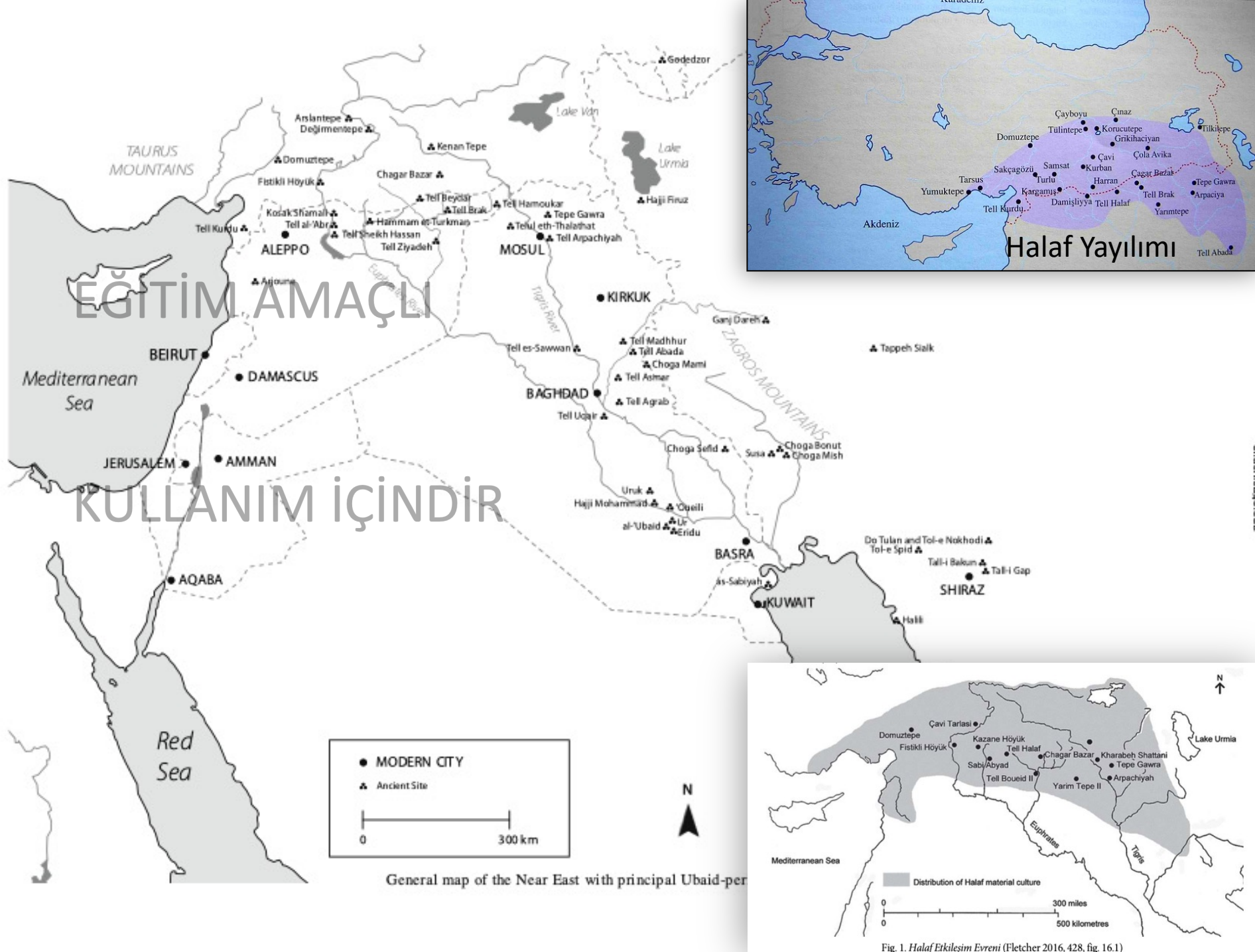

**İNCELEDİĞİMİZ KÜLTÜRLER  
İÇİN EN SON KABUL  
EDİLEN VE  
KULLANILAN KRONOLOJİK  
SIRALAMADIR**

PROTO (ÖN) HASSUNA ÖNCESİ	M.Ö.7000-6700	GEÇ NEOLİTİK 1
PROTO (ÖN) HASSUNA	M.Ö.6700-6300	GEÇ NEOLİTİK 2
ARKAİK HASSUNA /HALAF ÖNCESİ	M.Ö.6300-6000	GEÇ NEOLİTİK 3
HASSUNA-SAMARRA VE ÖN HALAF	M.Ö.6000-5900	GEÇ NEOLİTİK 4
HALAF (ERKEN-GEÇ)	M.Ö.5900-5300	GEÇ NEOLİTİK 5
HALAF-UBEYD GEÇİŞ EVRESİ	M.Ö.5300-5100	GEÇ NEOLİTİK 6
UBEYD	M.Ö.6500-3800	

**BURADA VERİLEN TARİHLER  
BİRBİRİNİ TAKİP ETMEYEBİLİR  
KÜLTÜRLER BİRBİRİNİN  
İÇİNDE BAŞLAYABİLİR VE  
BİRLİKTE DEVAM EDEBİLİR  
ÖZELİKLE KUZEY VE GÜNEY  
MEZOPOTAMYA  
BÖLGELERİNDEKİ YAYILIMLAR  
ETKİLEŞİMLER FARKLI  
TARİHLER VEREBİLİR**

**S. CAMPBELL TARAFINDAN 1992'DEN HALAF İÇİN KRONOLOJİ ÖNERİSİ.**

**HALAF Ia (DAHA ÖNCE ERKEN HALAF'TAN DAHA ERKEN)**

**HALAF Ib (ÖNCEKİ ERKEN HALAF)**

**HALAF IIa (ÖNCEKİ ORTA HALAF)**

**HALAF IIb (ÖNCEKİ GEÇ HALAF)**

## BAZI HALAF YERLEŐİMLERİ

Tel Tawila, Tel Huera'nın 10 km. güneyindedir. 2005 yılında kazılmaya başlanmıő. Alman-Suriye kazısıdır. Jan-Waalke Meye başkanlığında projesi yürütölmüő. Halaf ve Ubeyd Dönemleri var.

## TELL TAWILA

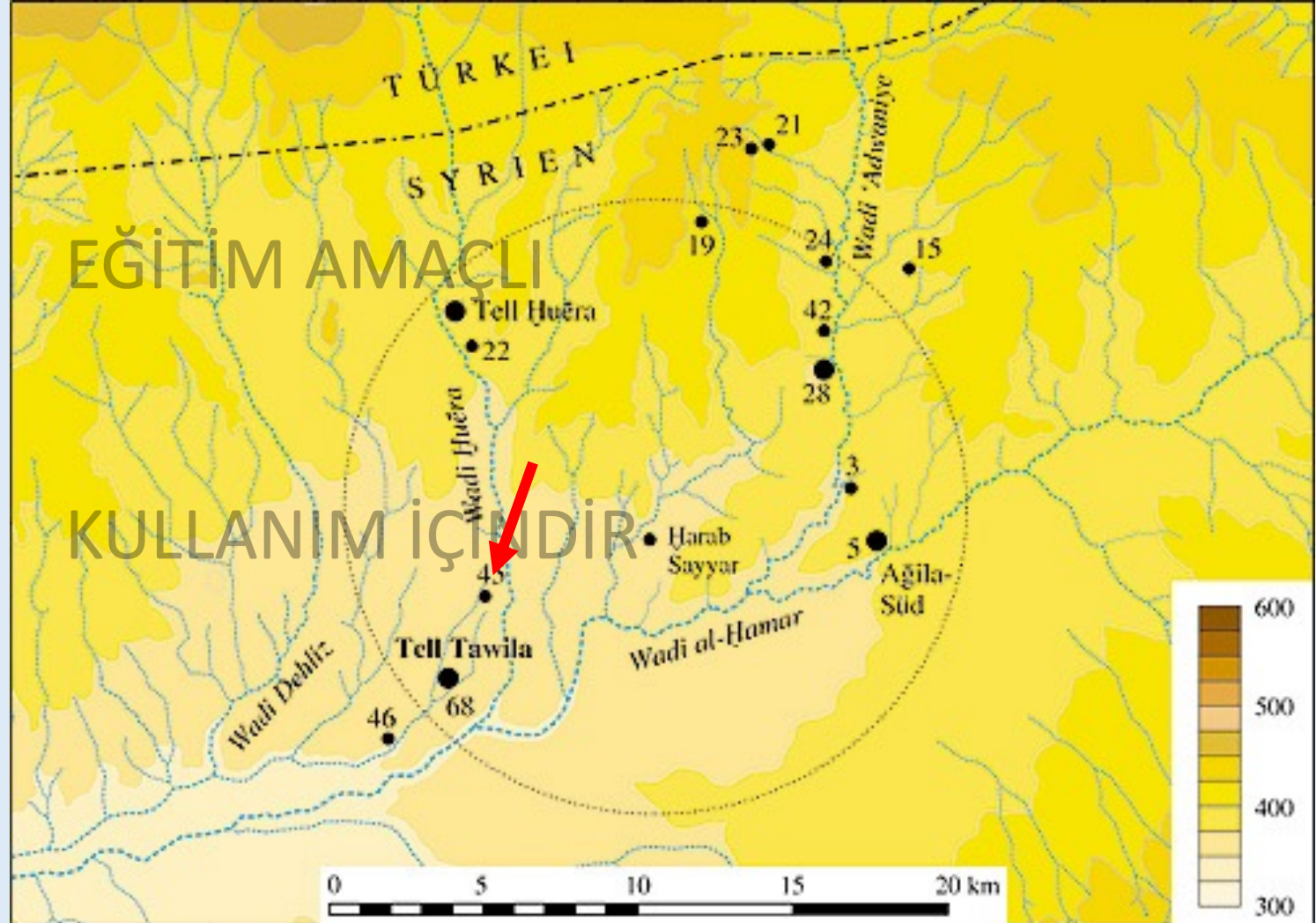

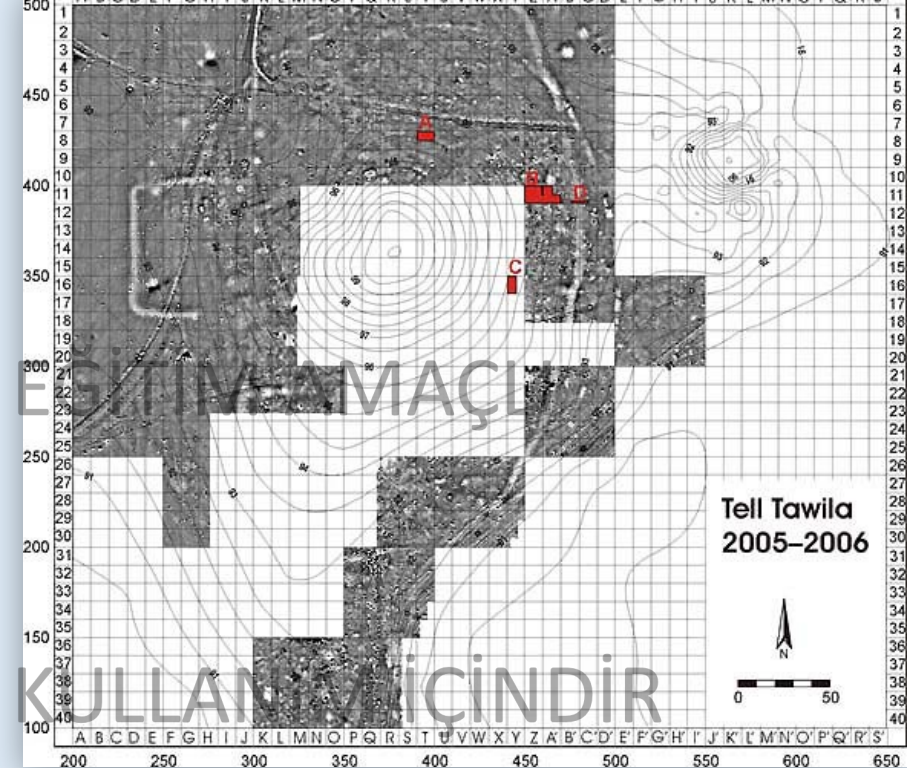
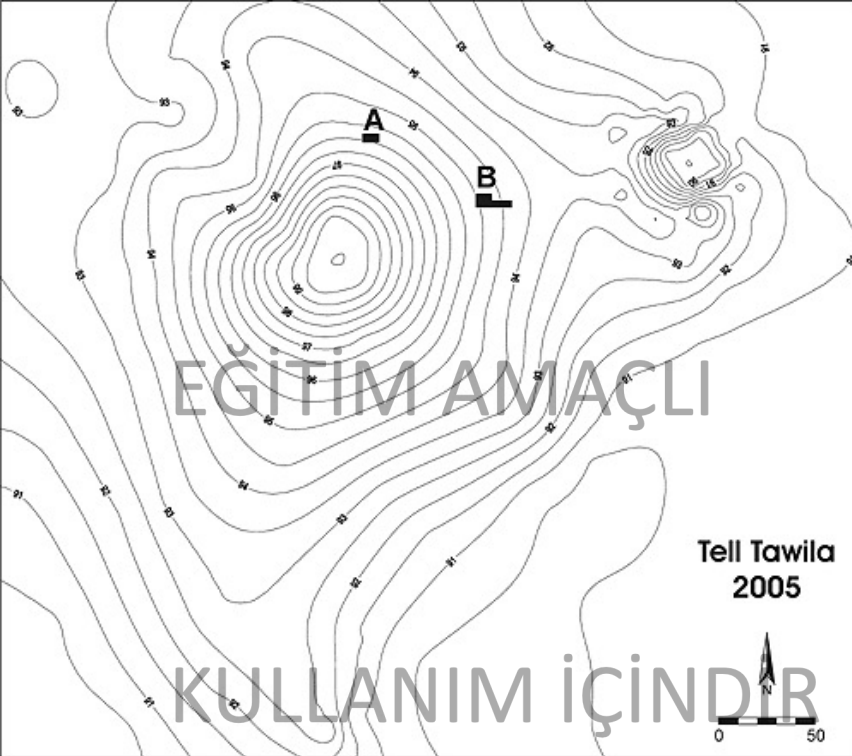

## TEL TAWİLA

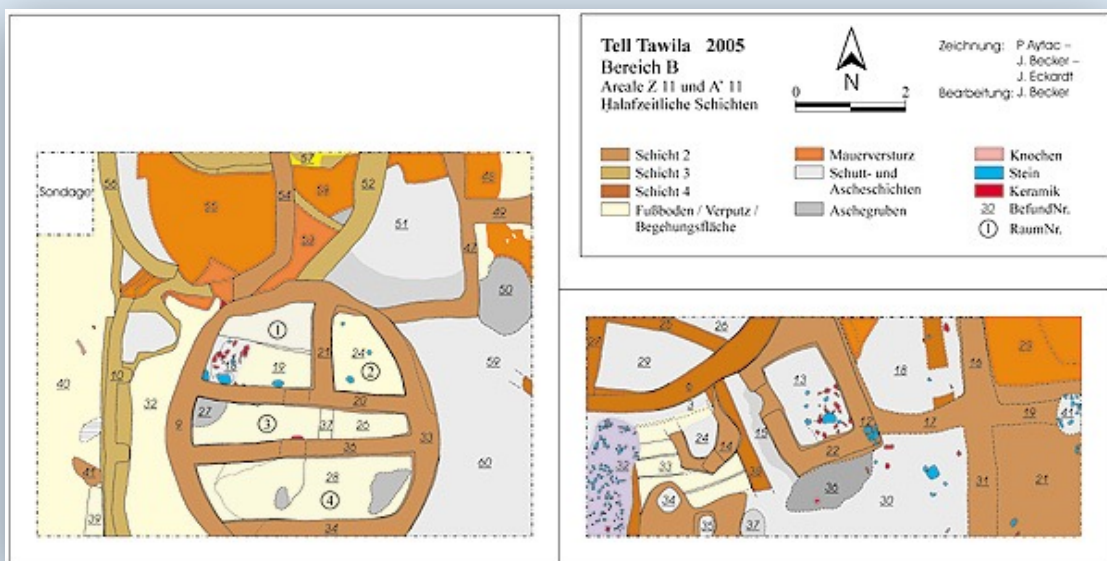



A Açması, Halaf Yapısı Seviye A4



B Açması, Halaf Tolosu Seviye B2



Seviye B2 B Açması, Halaf Seviyeleri 2a/b ve 4

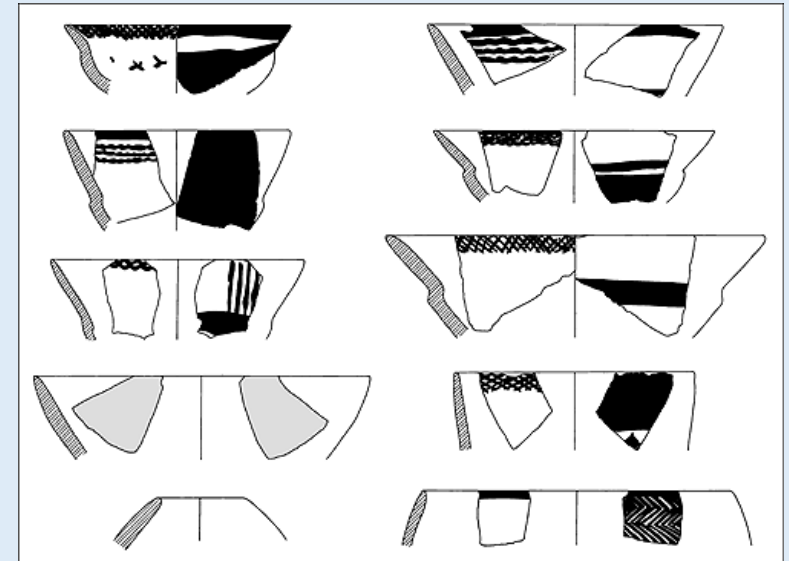

Halaf Seramikleri, B Açması

## TEL SABI ABYAD

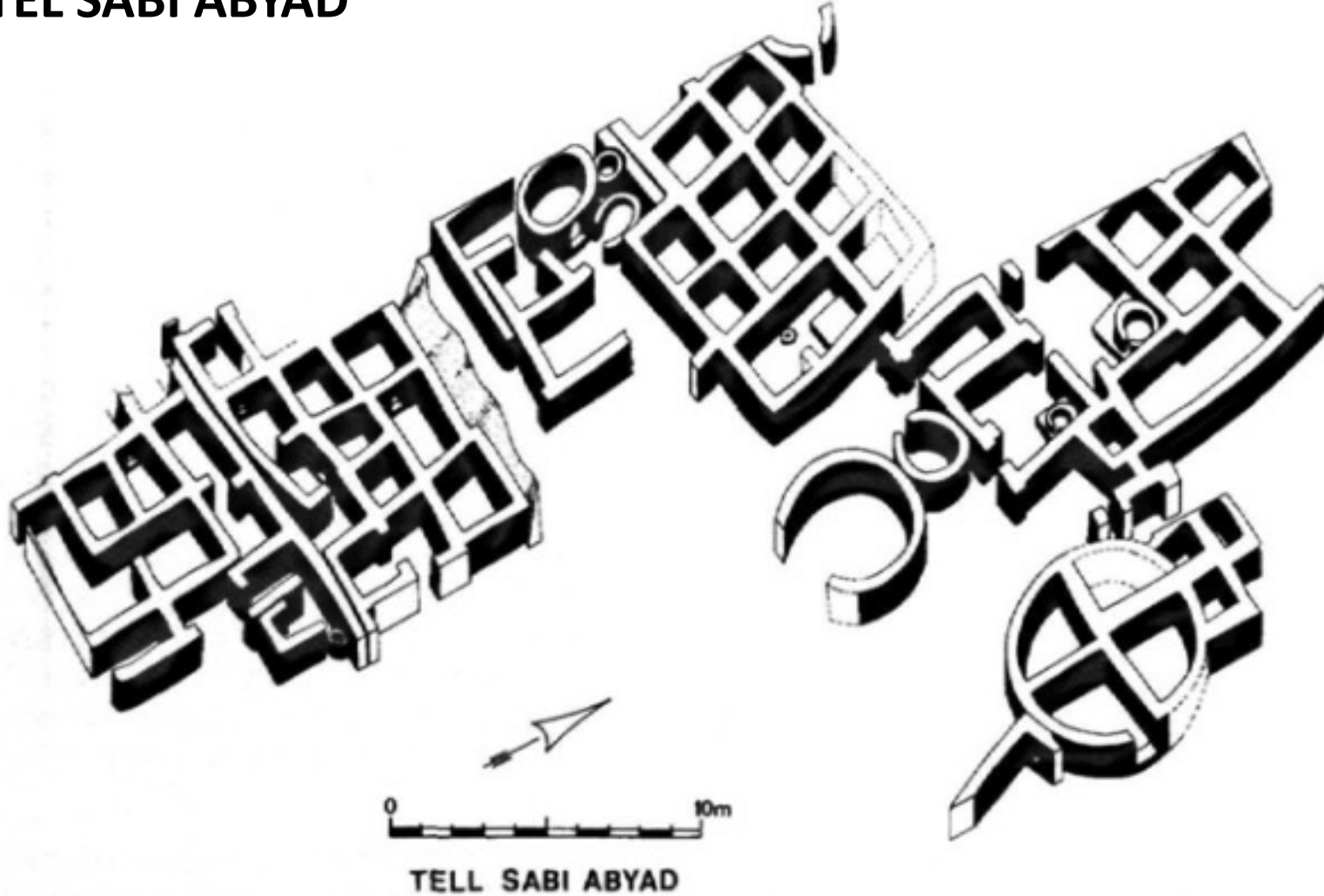

TEL SABI ABYAD, YANIK YERLEŞİM, HALAF



TEL SABI ABYAD MÜHÜR  
BASKISI GAZEL VEYA  
KEÇİLER M.Ö.5200 CİVARI



TEL SABI ABYAD MÜHÜR  
BASKISI BOĞA SBOYNUZLARI  
M.Ö.5200 CİVARI



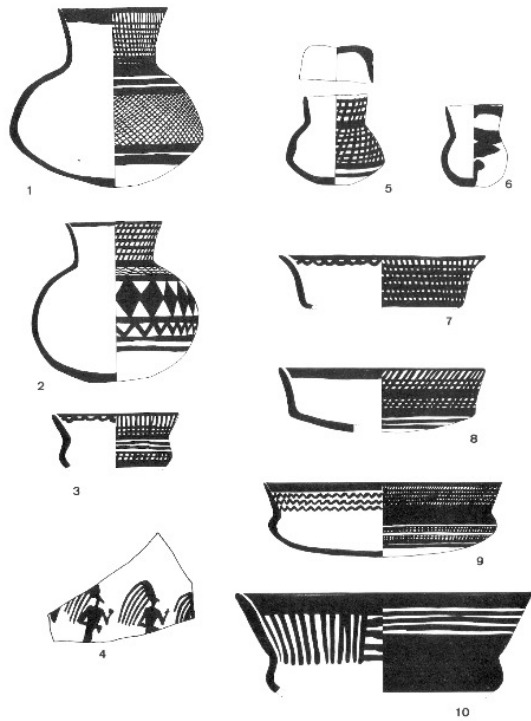
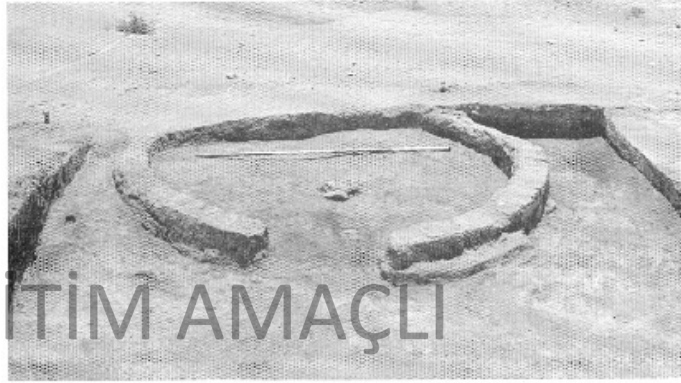

FIG. 4. — Early Halaf pottery from Tell Sabi Abyad (nos. 1-3, 5-10 scale 1:3; no. 4 scale 1:2).

28

EĞİTİM AMAÇLI



1

KULLANIM İÇİNDİR



2

Pl. II : 1. — Tholos in square P14, appearing immediately below the surface. The tholos was built upon the partly preserved remain earlier tholos. In its centre a stone platform for a wooden post is present.

Pl. II : 2. — Tholos in square P14. In the doorway a hinc serving us a dove worker was present. This tholos was rebuilt twice.

36

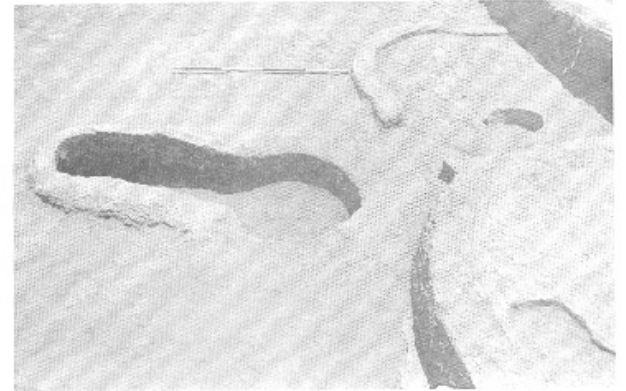

1



2



3



4



Pl. IV : 1. — Kishulio-stamped kiln in square P13. On the right parts of two tholoi are visible.

Pl. IV : 2. — Early Halaf female figurine from square T4. Baked clay. Actual height : 6.3 cm.

Pl. IV : 3. — Impression of clay cylinder seal or amulet (actual width of design : 4 cm).

38



FIG. 5. — Yarıy Halef pottery from Tell Nabi Abyad (scale 1:3).

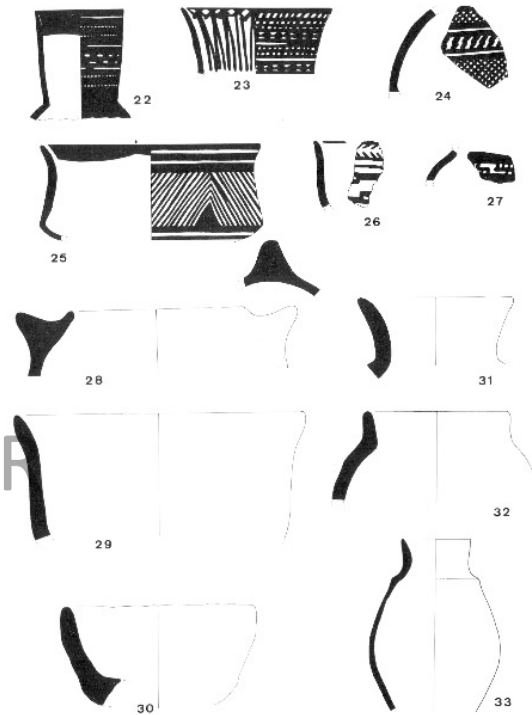

FIG. 6. — Samarra-related pottery (nos. 22-27) and Halef coarse ware (nos. 28-32) from Tell Nabi Abyad (scale 1:3). No. 33 represents a Late Neolithic jar found in square 714 (scale 1:10).

EĞİTİM AMAÇLI

KULLANIM İÇİNDİR

Sabi Abyad'ın güney kesimindeki Erken Halaf'ın yerleşimi ile yerleşim sona ermiştir. Bulunan birkaç Orta Halaf parçası bir tabakaya ait değildir. Olasılıkla bu evre başka bir yerde yaşamaya devam etmiş olmalıdır.

Yakınlardaki Tel Damishliyya'da küçük bir Orta Halaf yerleşimi mevcuttur. Burası küçük bir sit olup mevsimsel bir yerleşimdir. Balık bölgesinde birçok Halaf yerleşimi mevcuttur. Bunlar Damishliyya ile yakın benzerliğe sahip.

Damishliyya'da erken Halaf'tan sonra yerleşim stratejisinde farklı bir anlayışın ortaya çıktığı kabul edilmektedir. İki tür yerleşim modeli ortaya çıkmış olmalıdır: İlki Damishliyya tarzındaki mevsimlik olanlar diğeri ise büyük uzun süreli yerleşimlerdir. Her iki türdeki yerleşimler birbirleriyle ilişkili olmalıydılar.

**Damishliyya'da** büyük miktarda kaliteli Halaf seramiği bulunmuştur.



Map of Upper Mesopotamia showing the locations of sites mentioned in the text: 1) Tell Sabi Abyad; 2) Tell Damishliyya; 3) Mezraa Teleit; 4) Salat Cami Yani; 5) Tell Seker al-Aheimar; 6) Akar ay; 7) Tell Halula; 8) Tell el-Kerkh; 9) Shir.



Plate 14. Period III fine ware fragments from Tell Damishliyya (scale 1:2).

## Damishliyya Halaf Seramiği

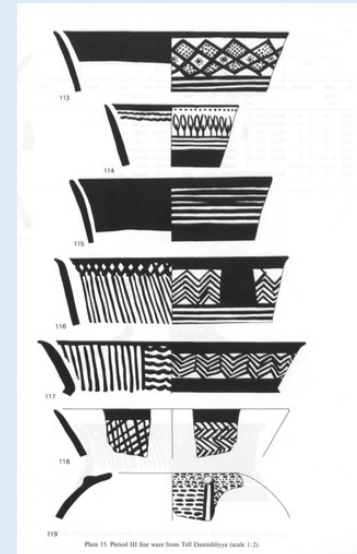
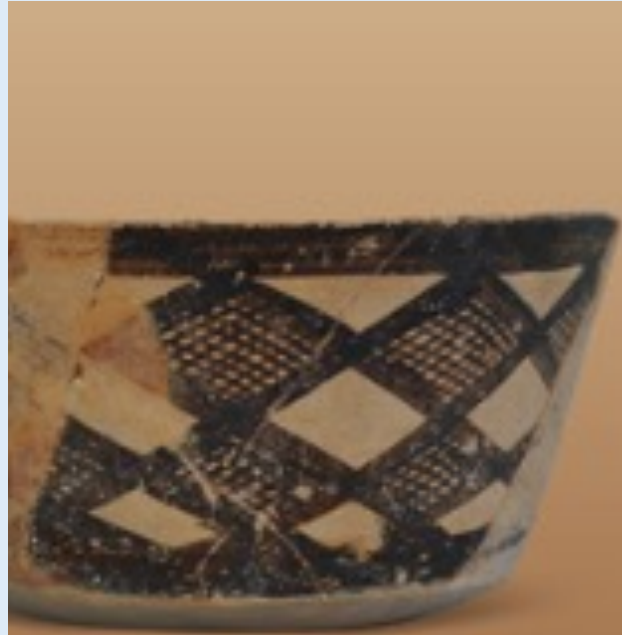

Plate 15. Period III fine ware from Tell Damishliyya (scale 1:2).

# KARAVELYAN HALAF SERAMİKLERİ



KARAVELYAN,  
DİYARBAKIR , BİSMLİ  
İLÇESİ, TEPE  
BELDESİ'NEDİR.  
HAKEMİ USE'NİN  
YAKLAŞIK 7  
KM  
DOĞUSUNDADIR.  
ZAYIF BİR İSKANDIR.

KULLANIM İÇİNDİR



EĞİTİM AMAÇLI

KULLANIM İÇİNDİR

## CAGAR PAZAR

Cagar Pazar, 1935-1938'de M.Mallowan tarafından kazıldı. Kuzeydoğu Suriye'de yukarı Habur bölgesindedir.

EĞİTİM AMAÇLI  
KULLANIM İÇİNDİR

Höyük 12 hektarlık bir alana yayılmıştır. En yüksek noktası ise 21 metredir. Üç sezonluk çalışmada Erken Halaf'tan M.Ö.2. bin yılın ortasına kadar yerleşimler ortaya çıkarılmış.





## CAGAR PAZAR

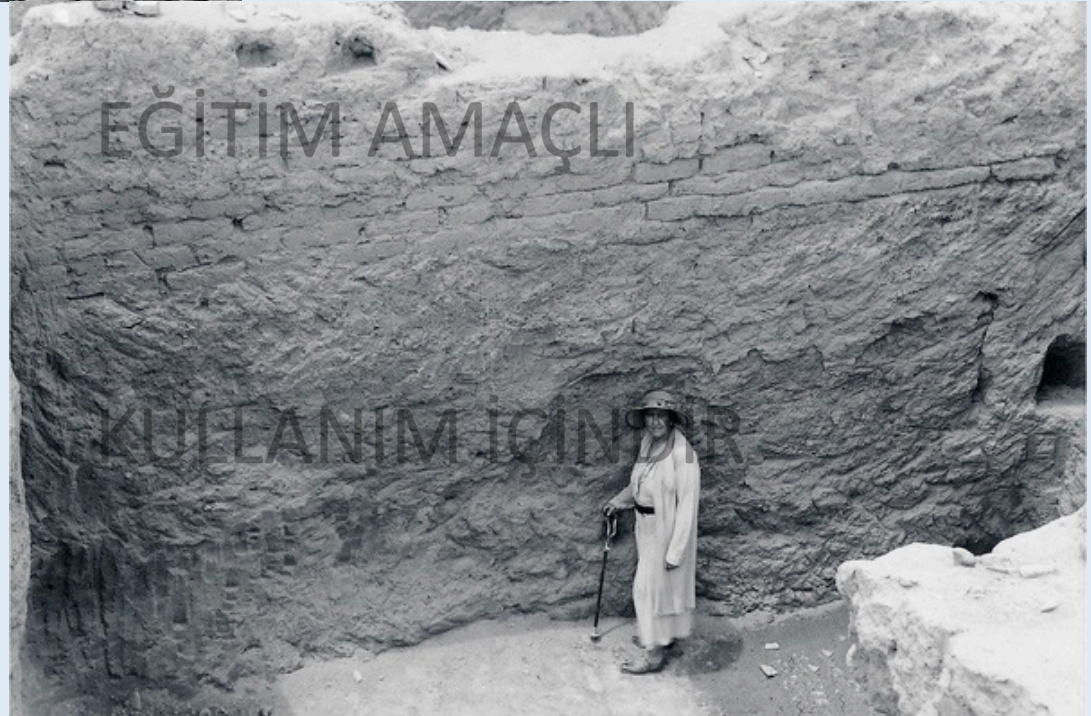

# KERKÜŞTİ HÖYÜK

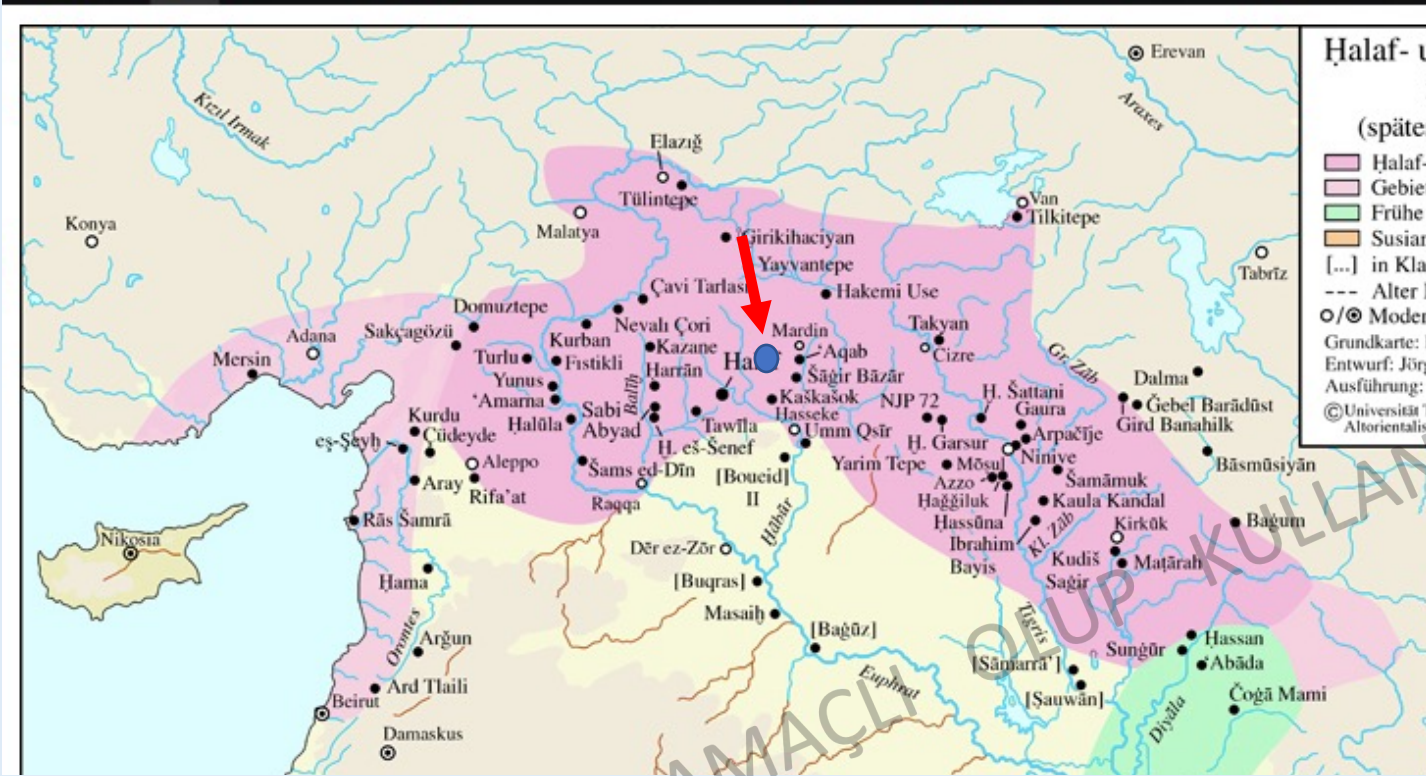

Mardin İli Derik İlçesi sınırları içindedir.

Tabakalaşım:

I. Ortaçağ ve sonrası

II. Roma Dönemi (yerel)

III. Orta Tunç Çağı

IV. Son Kalkolitik

V. Halaf Dönemi

VI. Halaf dönemi (yerel)

Gelişkin Halaf kültürü:

Tel Halaf

Tel Arpaçiya

Yarım Tepe II-III



## KERKÜŞTİ HÖYÜK

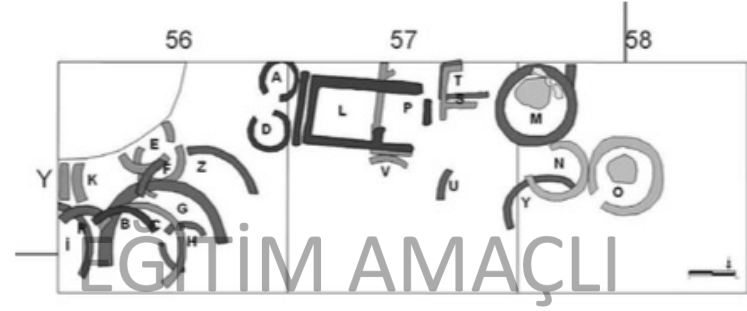

Fig. 4 Kerküştü Höyük, Halaf Dönemi yapılarının dağılımı  
Distribution of structures at Kerküştü Höyük during the Halaf Period







EĞİTİM AMAÇLI

KULLANIM İÇİNDİR



EĞİTİM AMAÇLI

KULLANIM İÇİNDİR

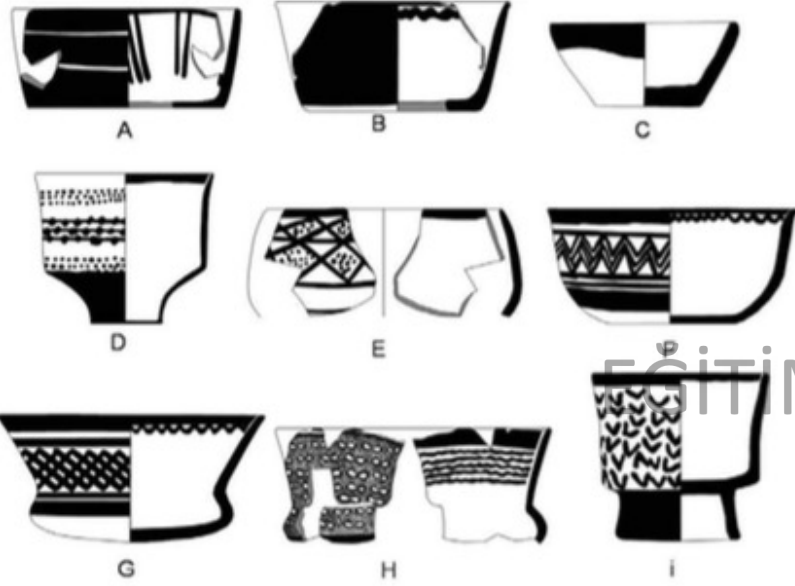

Fig. 13 Kaseler  
Bowls

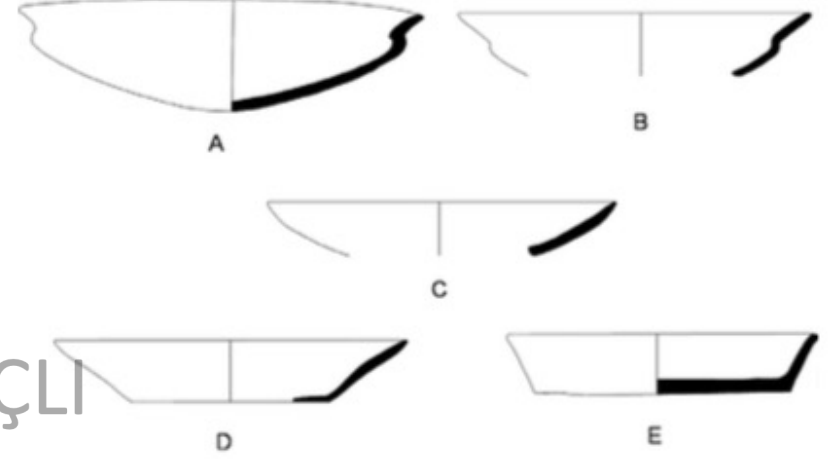
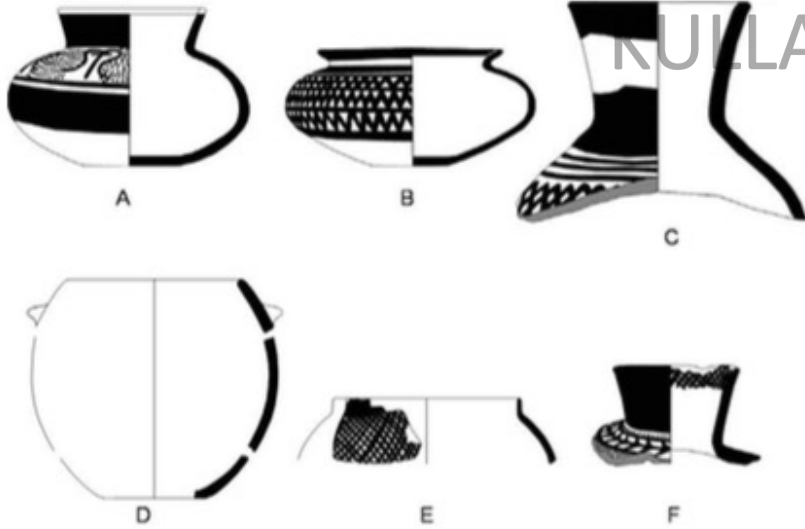

Fig. 15 Tabaklar  
Plates



## HALAF SERAMİK ÖRNEKLERİ

## BAŞLICA KAYNAKLAR

**Akkermans, P.M.M.G.**, Excavations at Tell Sabi Abyad. BAR IS 468. Oxford 1989

**Akkermans, P.M.M.G.**, Old and New Perspectives on the Origins of the Halaf-Culture, in: Rouault, O. / M. Wäfler (Hrsg.) La Djézire et l'Euphrate syriens de la protohistoire à la fin du IIe millénaire. Subartu VII. Brepols 2000, 3-54

**Akkermans, P.M.M.G.**, Villages in the Steppe: Later Neolithic Settlement and Subsistence in the Balikh Valley, Northern Syria. International Monographs in Prehistory, Archaeological Series 5. Michigan 1993

**Akkermans, P.M.M.G. (Hrsg.)**, Tell Sabi Abyad - The Late Neolithic Settlement. Report of the Excavations of the University of Amsterdam (1988) and the Nat. Mus. of Antiquities Leiden (1991-1993), Vol. I-II. Istanbul 1996

**Akkermans, P.M.M.G. / B. Wittmann**, Khirbet es-Shenef 1991, eine späthalafzeitliche Siedlung im Balikhthal, Nordsyrien. MDOG 125, 1993, 143-166

**Akkermans, P.M.M.G. / M. LeMière**, The 1988 Excavations at Tell Sabi Abyad, a Later Neolithic Village in Northern Syria. AJA 96, 1992, 1-22

**Bartl, K.**, Zur Datierung der altmonochromen Ware von Tell Halaf, in: O.M.C. Haex u.a. (Hrsg.), To the Euphrates and Beyond: Archaeological Studies in Honor of M.N. van Loon. Rotterdam / Brookfield 1989, 257-274

**Breniquet, C.**, La disparition de la culture de Halaf: les origines de la culture d'Obeid dans le nord de la Mésopotamie. Paris 1996

- Campbell, S.**, Culture, Chronology and Change in the Later Neolithic of North Mesopotamia. unpubl. Ph.D.-These. Edinburgh, 1992
- Campbell, S.**, Problems of Definition: The Origins of the Halaf Culture in North Iraq, in: Lebeau, M. (Hrsg.) Subartu IV: Studies devoted to Upper Mesopotamia. Vol 1: Landscape, Archaeology, Settlement. Brepols 1998, 39-52
- Davidson, T.E.**, Regional Variation within the Halaf Ceramic Tradition, I-II. Unpubl. Diss. Edinburgh 1977
- Frankel, D.**, Archaeologists at Work: Studies on Halaf Pottery. London 1979
- Gut, R.V.**, Das prähistorische Ninive: Zur relativen Chronologie der frühen Perioden Nordmesopotamiens. BaF 19. Mainz 1995
- Hijara, I. u.a.**, Arpachiyah 1976. Iraq 42, 1980, 131-154
- Hijara, I.**, The Halaf Period in Northern Mesopotamia. Edubba 6. London 1997
- Mallowan, M.E.L. / C. Rose**, Excavations at Tall Arpachiyah. Iraq 2, 1935, 1-178
- Van Loon, M.N.** (Hrsg.), Hammam et-Turkman I, Report on the University of Amsterdam's 1981-1984 Excavations in Syria I-II. Istanbul 1988
- Verhoeven, M.**, An Archaeological Ethnography of a Neolithic Community: Space, Place and Social Relations in the Burnt Village at Tell Sabi Abyad, Syria. Istanbul 1999
- von Oppenheim, M. / H. Schmidt**, Tell Halaf I: Die prähistorischen Funde. Berlin 1943
- von Wickede, A.**, Die Ornamentik der Tell Halaf-Keramik: Ein Beitrag zu ihrer Typologie. APA 18, 1986, 7-32
- Yoffee, N. / J.J. Clark** (Hrsg.), Early Stages in the Evolution of Mesopotamian Civilization: Soviet Excavations in Northern Iraq. Tucson 1993