

# ARC 212 ARCHAEOLOGY OF THE AEGEAN

**Prof. Dr. Vasif Şahođlu**

**Course 10: Early Helladic Culture**

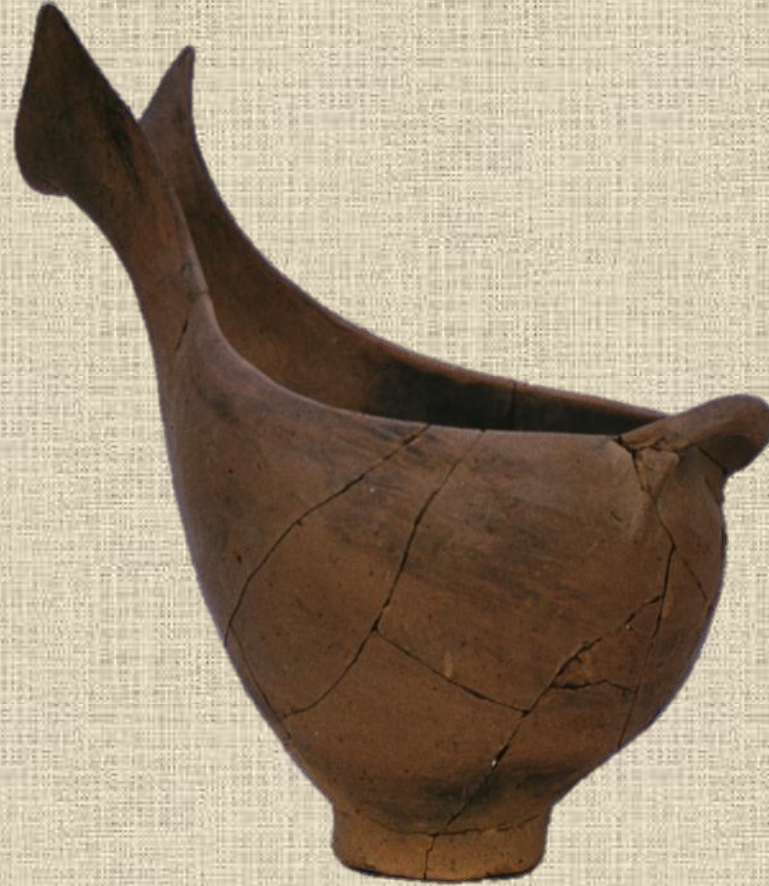

**Ankara University**  
**Faculty of Languages and History - Geography**  
**Department of Archaeology**

# Early Helladic Culture

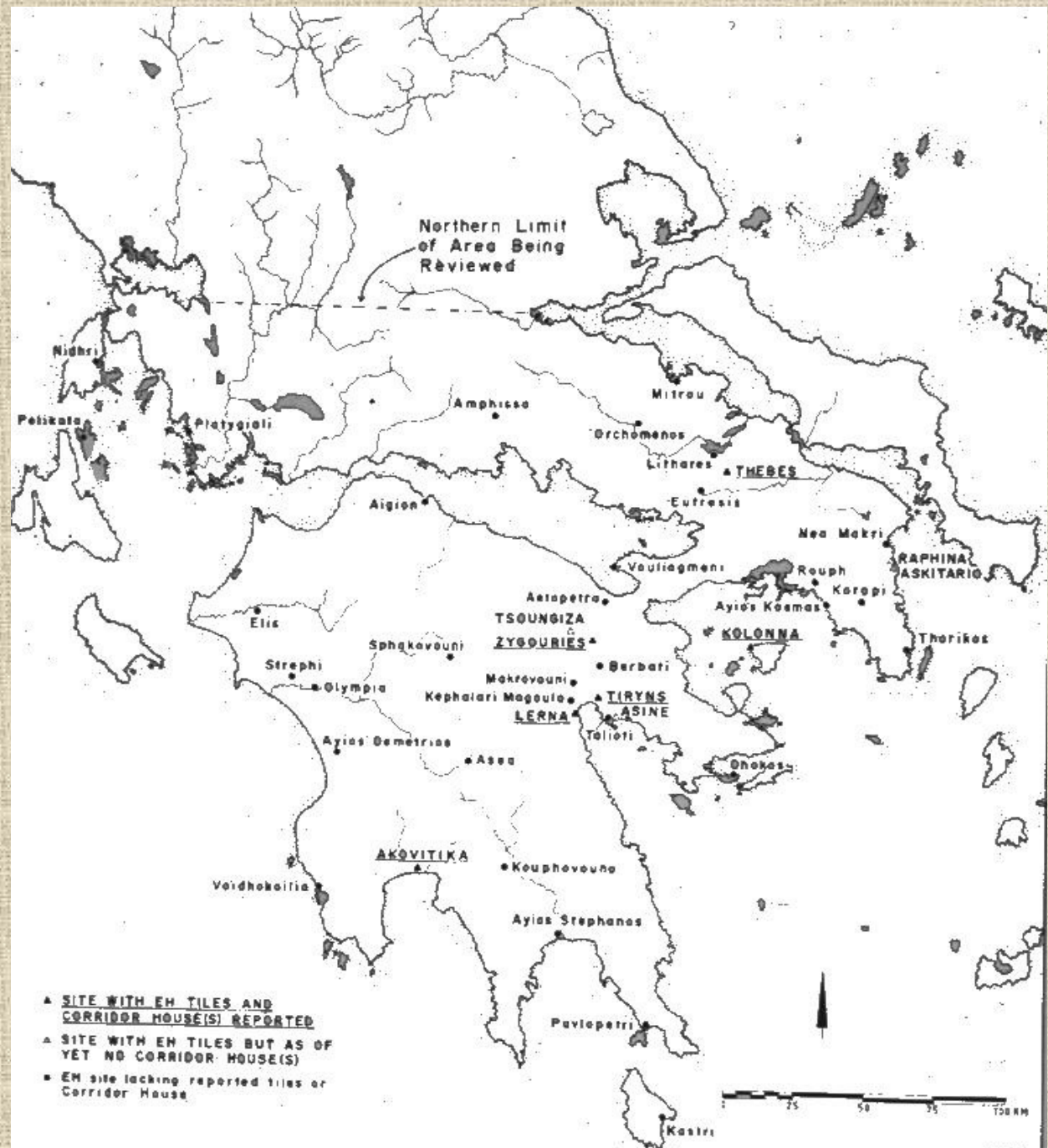

# Early Helladic Culture

# Chronology

Chronology High Low	Crete	Cyclades	Greece	Egypt			
3100	EM I	EC I	EH I	1 <sup>st</sup> -2 <sup>nd</sup> Dynasty 3100/3000-2700			
2900							
2800	EM IIA	EC II	EH IIA	Old Kingdom (2700-2136)			
2600							
2500							
2400	EM IIB		EH IIB				
2300							
2200	EM III	EC III	EH III	1 <sup>st</sup> Intermediate Period (2136-2023)			
2100							
2000	MM IA	MC I	MH I	Middle Kingdom (2116-1795)			
1900							
1800	MM IB	MC II	MH II				
1700							
1600	MM III	MC III	MH III	2 <sup>nd</sup> Intermediate Period (1795-1540)			
1500							
1500	LM IA	LC I	LH I	New Kingdom (1540-1070)			
1400							
1400	LM IB	LC II	LH IIA	Hatshepsut/ Tutmosis III	1479-1425		
1300							
1300	LM II		LH IIB	18 <sup>th</sup> Dynasty (1540-1295)	Amenhotep III	1391-1353	
1300							
1300	LM IIIA1		LH IIIA1		Akhenaten	1353-1337	
1300							
1300	LM IIIA2		LH IIIA2		19 <sup>th</sup> Dynasty (1295-1186)	Ramses II	1279-1213
1200							
1200	LM IIIB	LC III	LH IIIB		20 <sup>th</sup> Dynasty (1186-1070)	Ramses III	1184-1153
1100							
1100	LM IIIC		LH IIIC				
1000							
1000	Subminoan		Submycenaean				

EH I.....Eutresis Culture  
(within it regional Talioti Culture)

EH IIA.....Korakou Culture

EH IIB.....Lefkandi I Culture

EH III..... Tiryns Culture  
Lerna IV

FIGURE 1.1. Table of Aegean relative and absolute chronology. Table by Dan Davis.

## Early Helladic Culture

Eutresis Culture / Early Helladic I  
(3100/3000 – 2650 BC)

Pottery



Eutresis

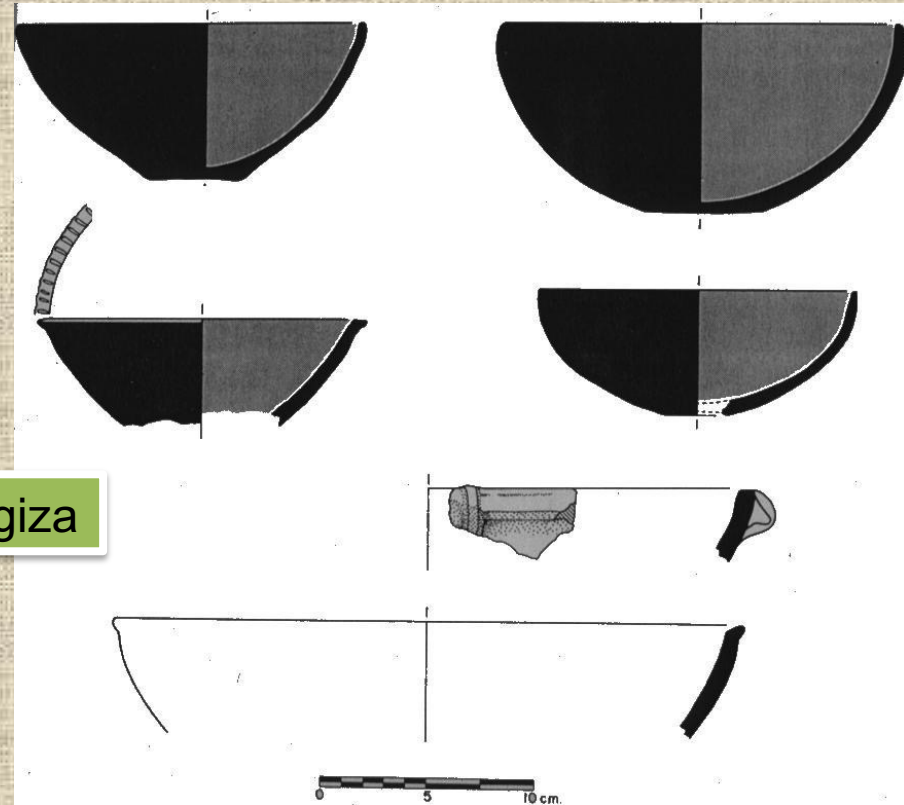

Tsoungiza

Red polished pottery is characteristic. Simple incised decorations can also be seen.

## Early Helladic Culture

Eutresis Culture / Early Helladic I  
(3100/3000 – 2650 BC)

### Pottery

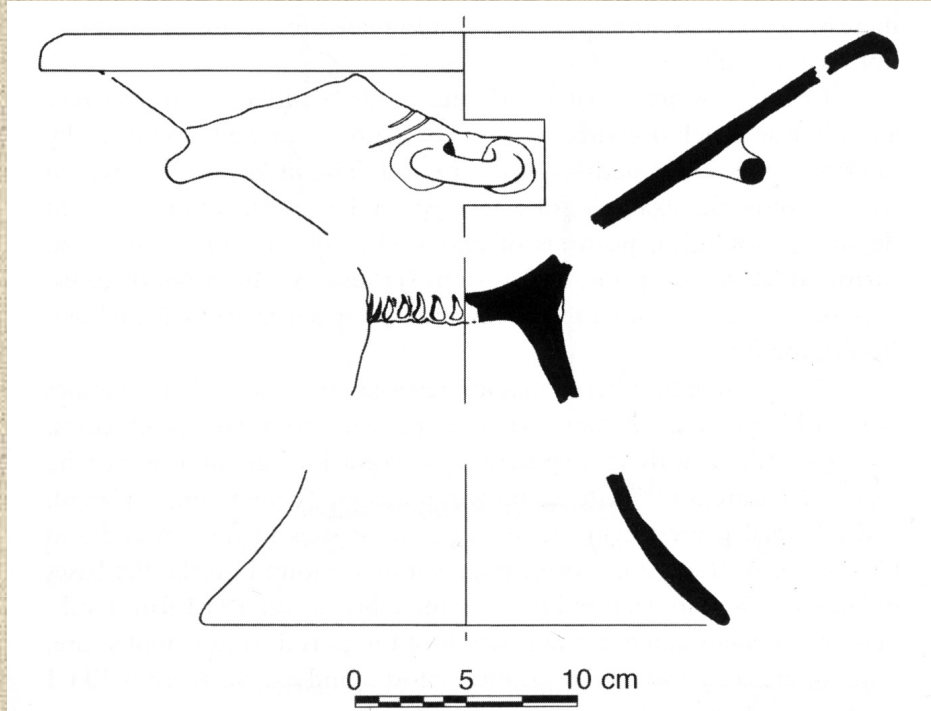

FIGURE 2.1. Fruitstand (composite reconstruction), EH I. Drawing by Julia E. Pfaff.  
Courtesy of the author.



**Talioti group of pottery is usually red slipped and not burnished. Pedestalled bowls is the most common shape.**

# Early Helladic Culture

Korakou Culture / Early Helladic II  
(2650-2200/2150 BC)

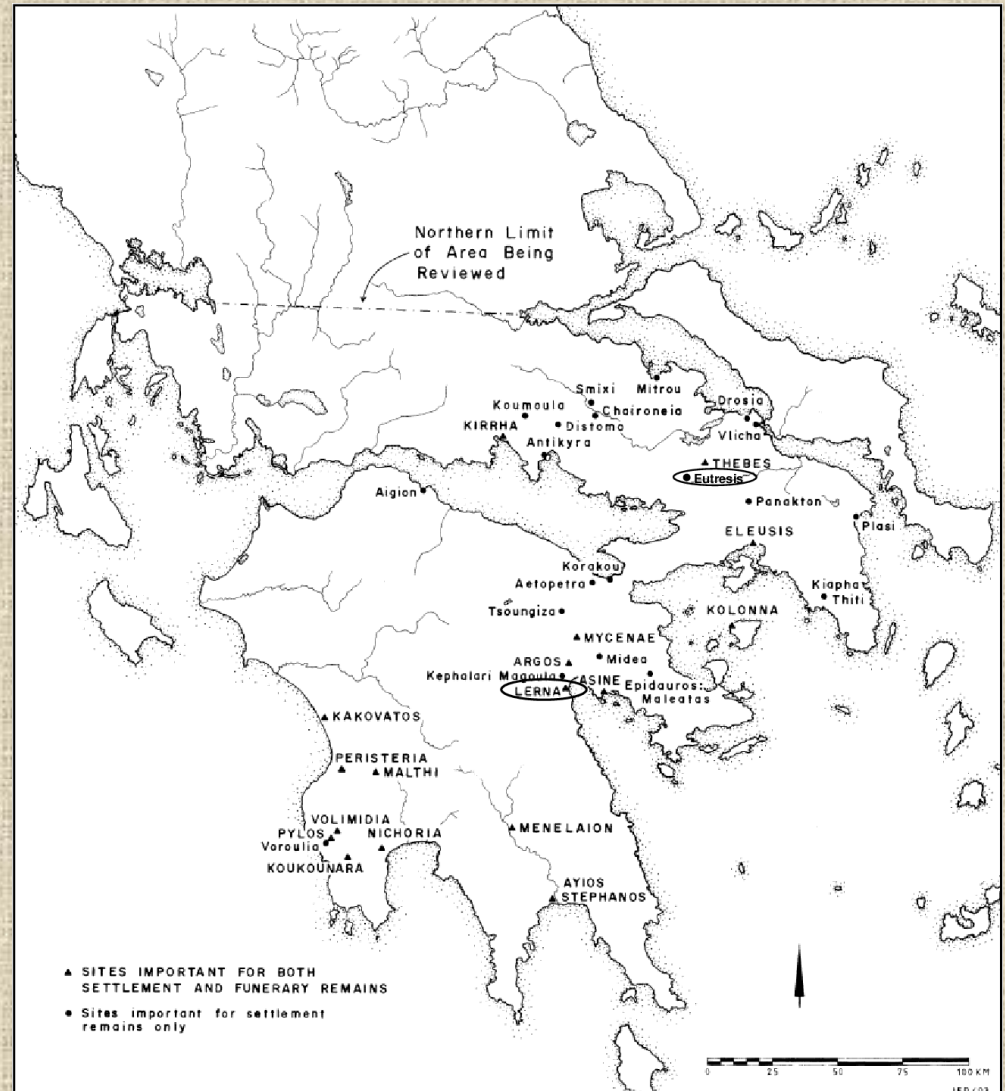
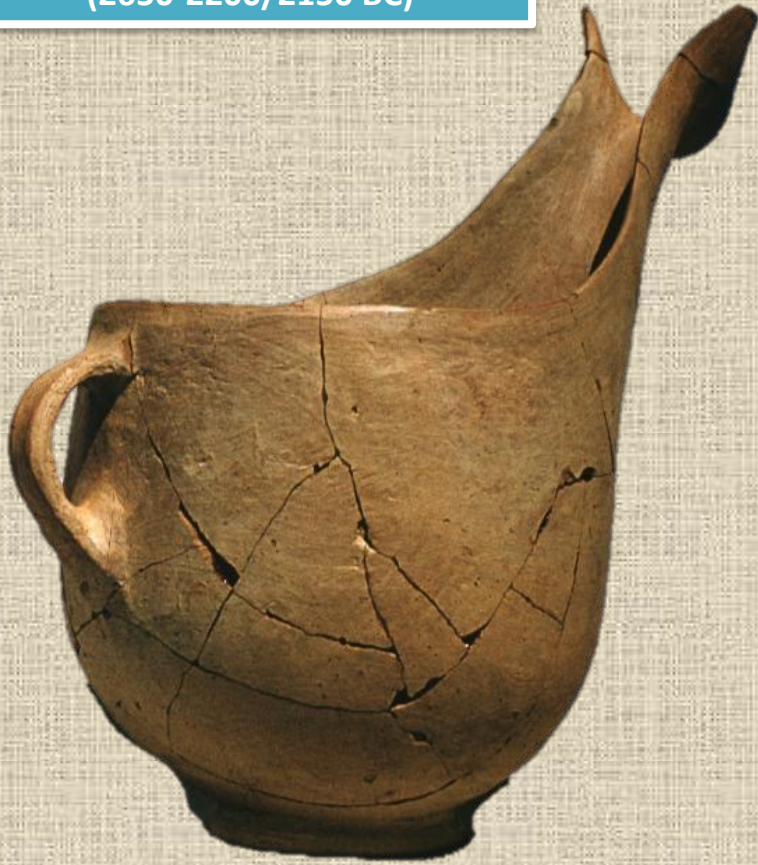

## Early Helladic Culture

Korakou Culture / Early Helladic II  
(2650-2200/2150 BC)

## Settlement Architecture



Manika

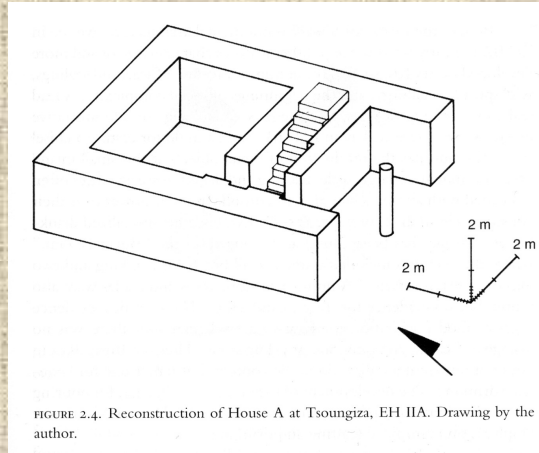
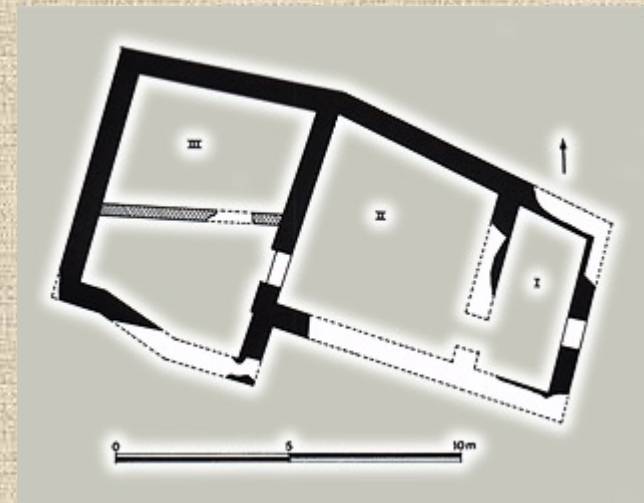

FIGURE 2.4. Reconstruction of House A at Tsoungiza, EH IIA. Drawing by the author.

Tsoungiza



Eutresis

EH II domestic architecture is usually rectangular in form. They have flat roofs and have hearths in the main room of the house. They usually have multi rooms.



Lerna: Stone foundation with mudbrick superstructure

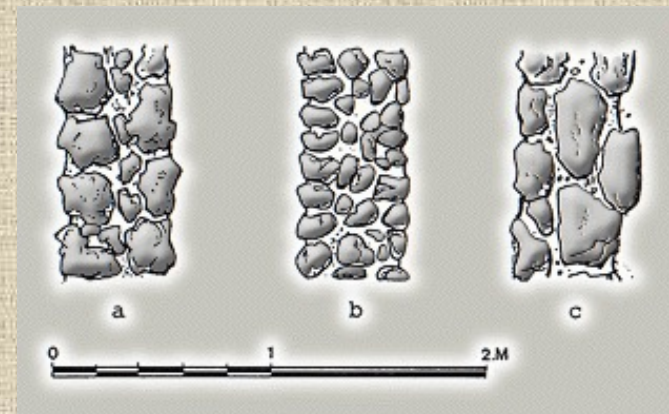

Lithares: Wall construction

# Early Helladic Culture

Korakou Culture / Early Helladic II  
(2650-2200/2150 BC)

## Administrative Buildings

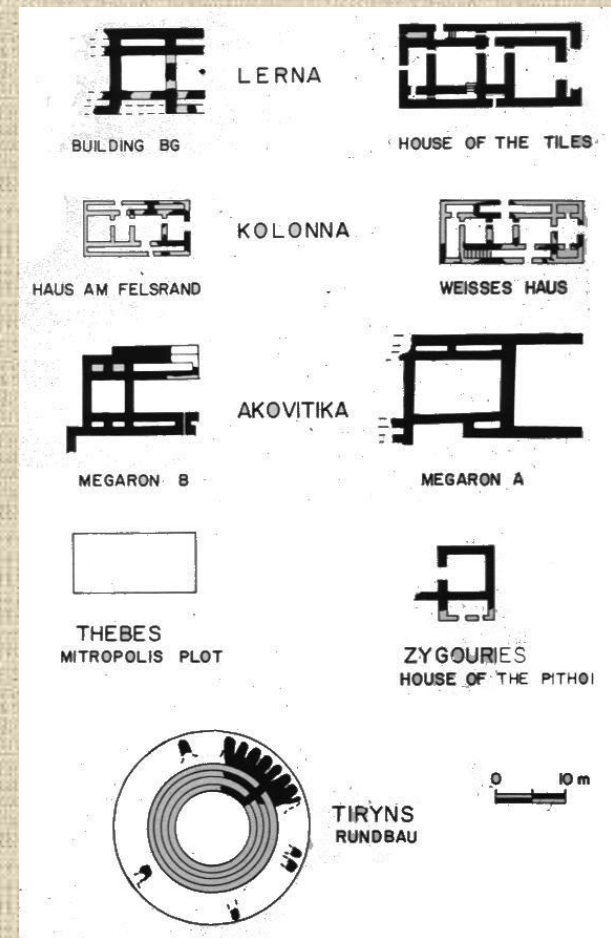

Some of the settlements are surrounded with fortifications. (Lerna, Askitarion, Kolonna)

For the first time there appear to be administrative and special function buildings:

(Lerna –house of the Tiles, BG House, Aegina Kolonna – White House, Thebes – Fortified Building, Zygouries – Pithos House...)

Only the Rundbau at Tiryns reflects a rather different plan.



# Early Helladic Culture

Korakou Culture / Early Helladic II  
(2650-2200/2150 BC)

## Administrative Buildings

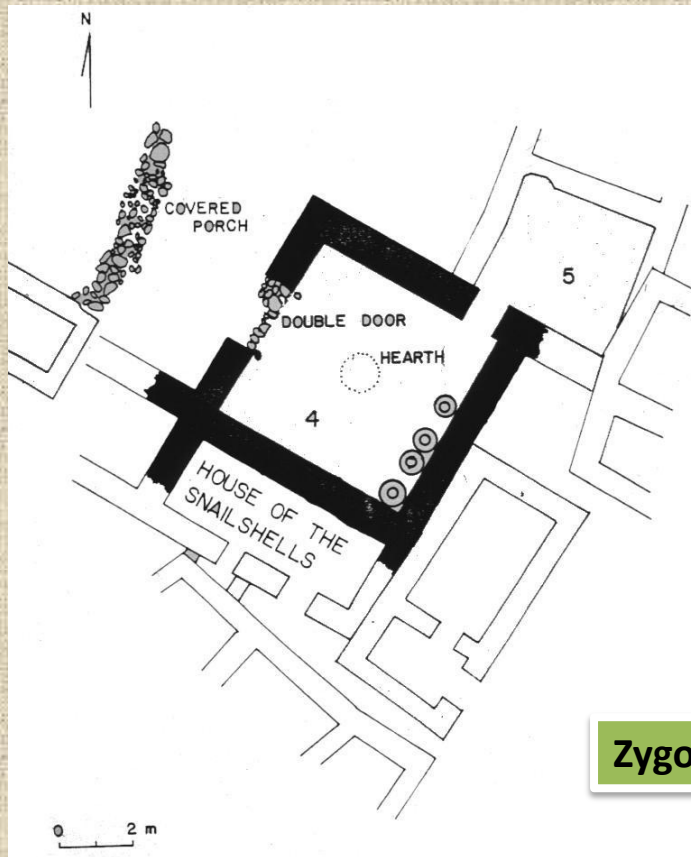

Zygories

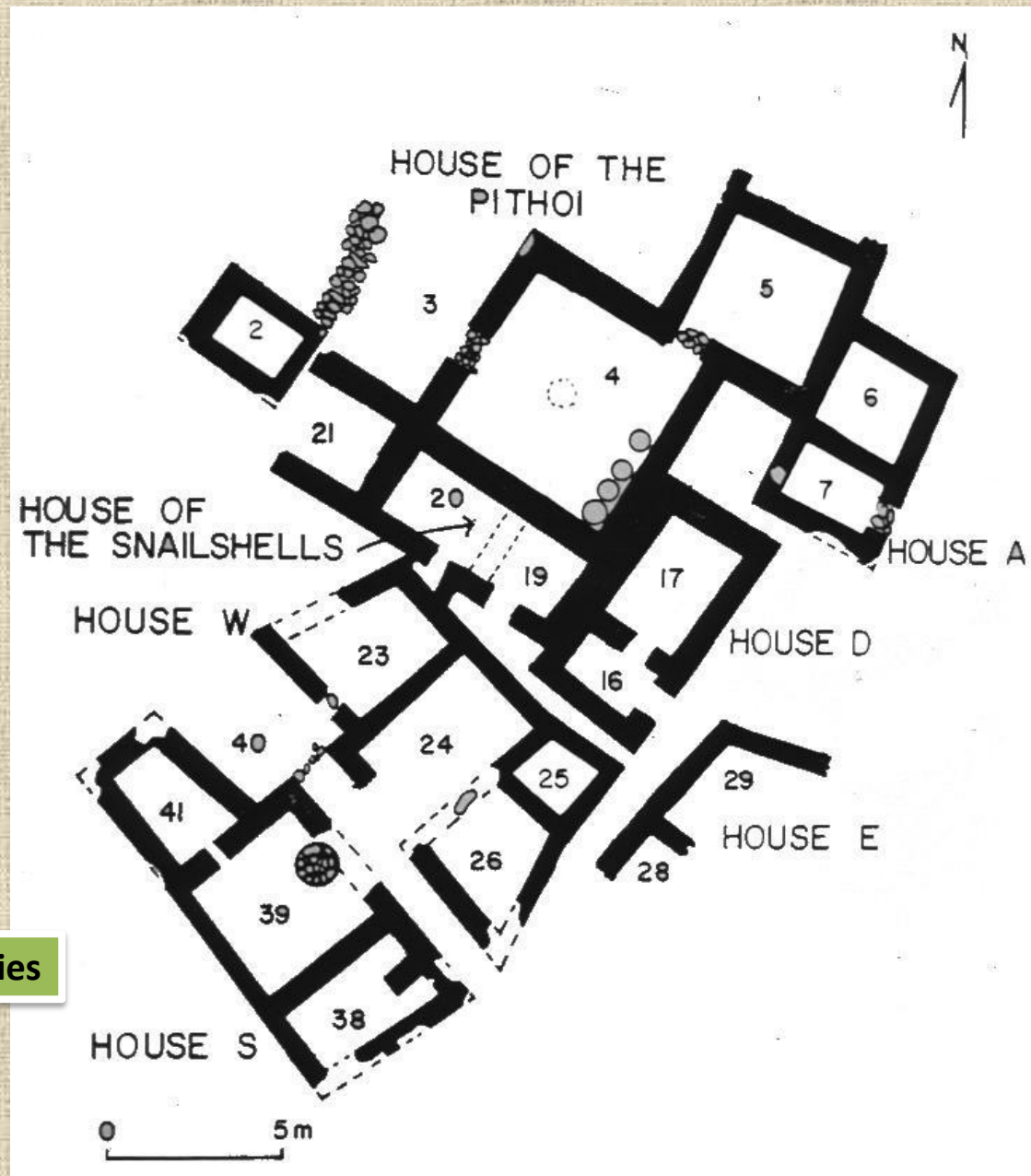

# Early Helladic Culture

# EARLY HELLADIC II ARCHITECTURE

Korakou Culture / Early Helladic II  
(2650-2200/2150 BC)

## Administrative Buildings

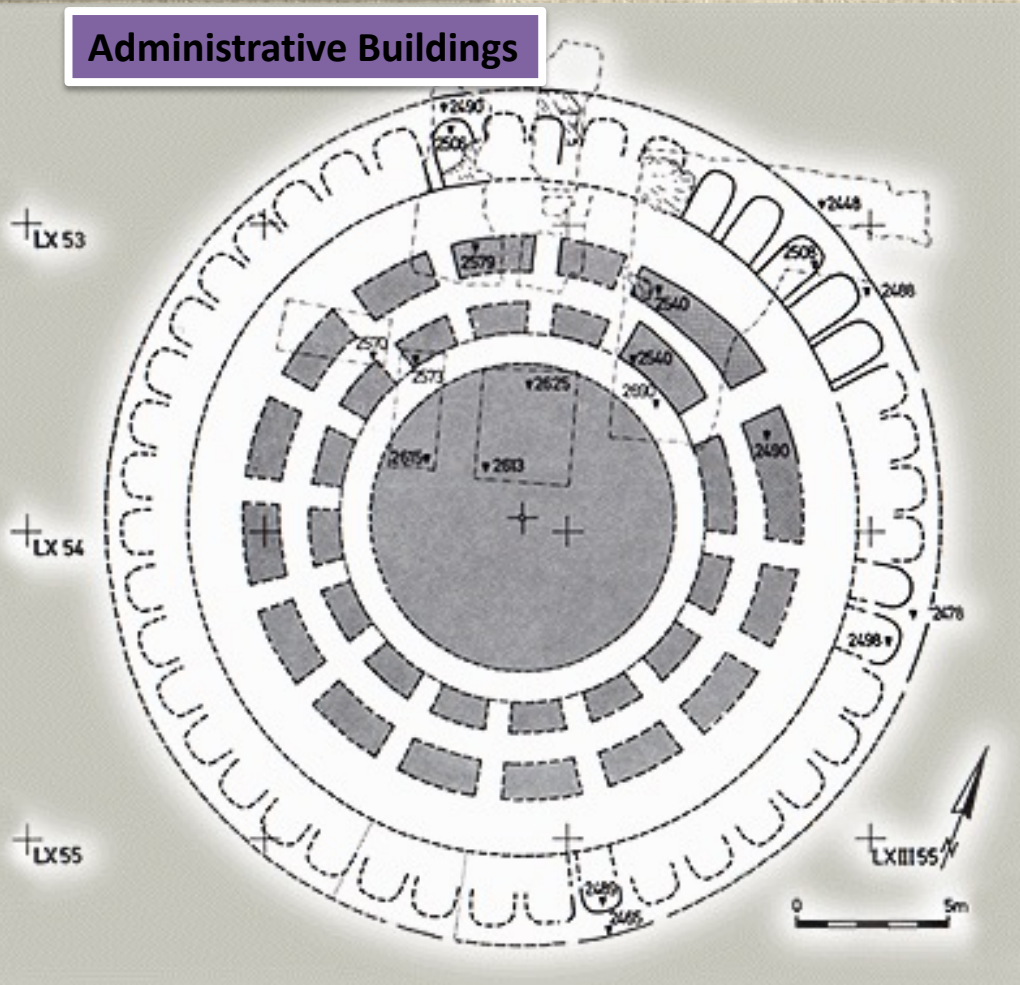

Tiryns 'Rundbau'

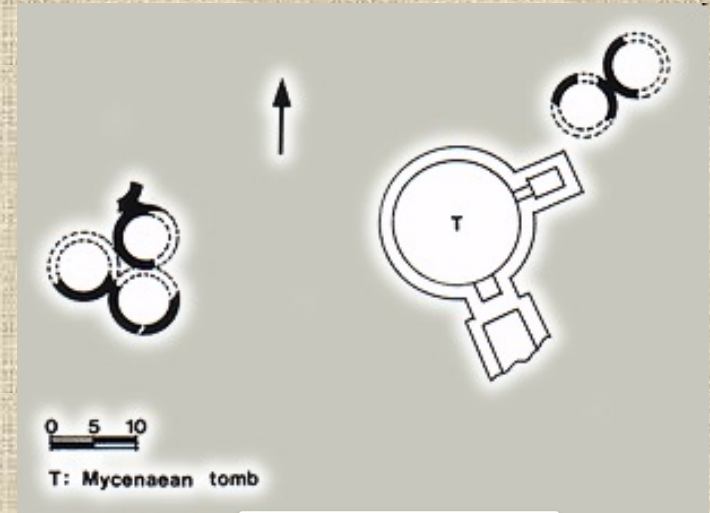

Orchomenos

## Early Helladic Culture

Korakou Culture / Early Helladic II  
(2650-2200/2150 BC)

### Fortification System

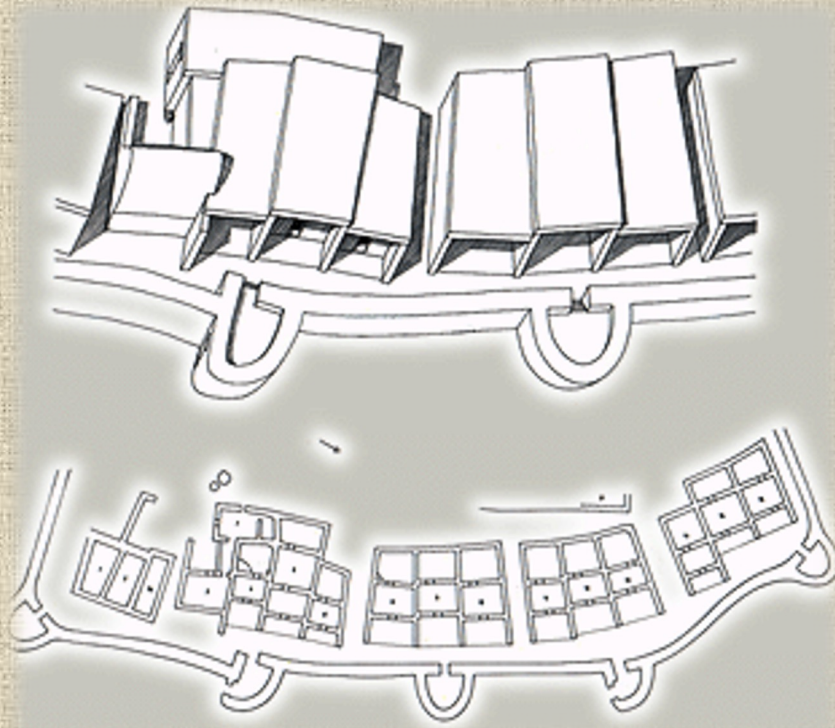

Aegina Kolonna V Settlement and Fortification

## Early Helladic Culture

Korakou Culture / Early Helladic II  
(2650-2200/2150 BC)

### Administrative Buildings

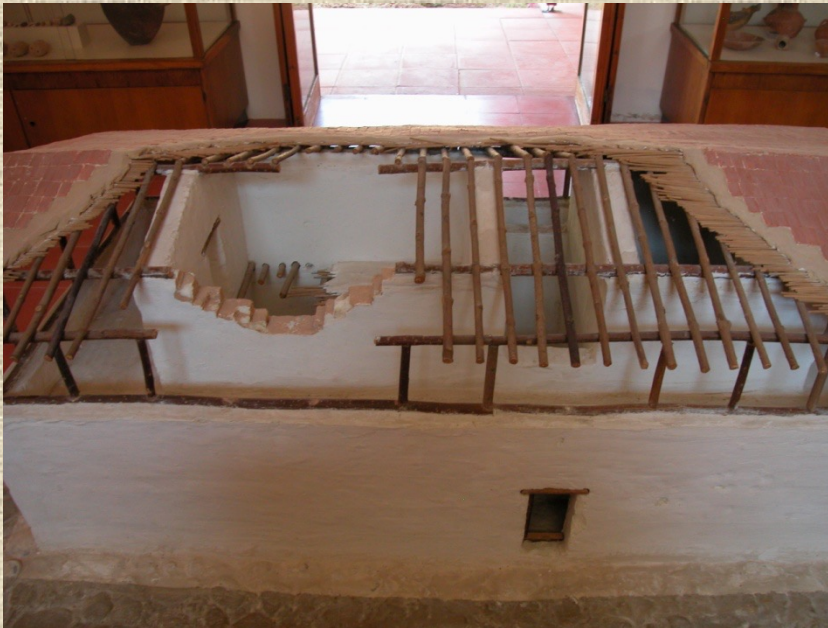

Aegina Kolonna III, Corridor House (Weisses Haus) model.

# Early Helladic Culture

Korakou Culture / Early Helladic II  
(2650-2200/2150 BC)

## Fortification System

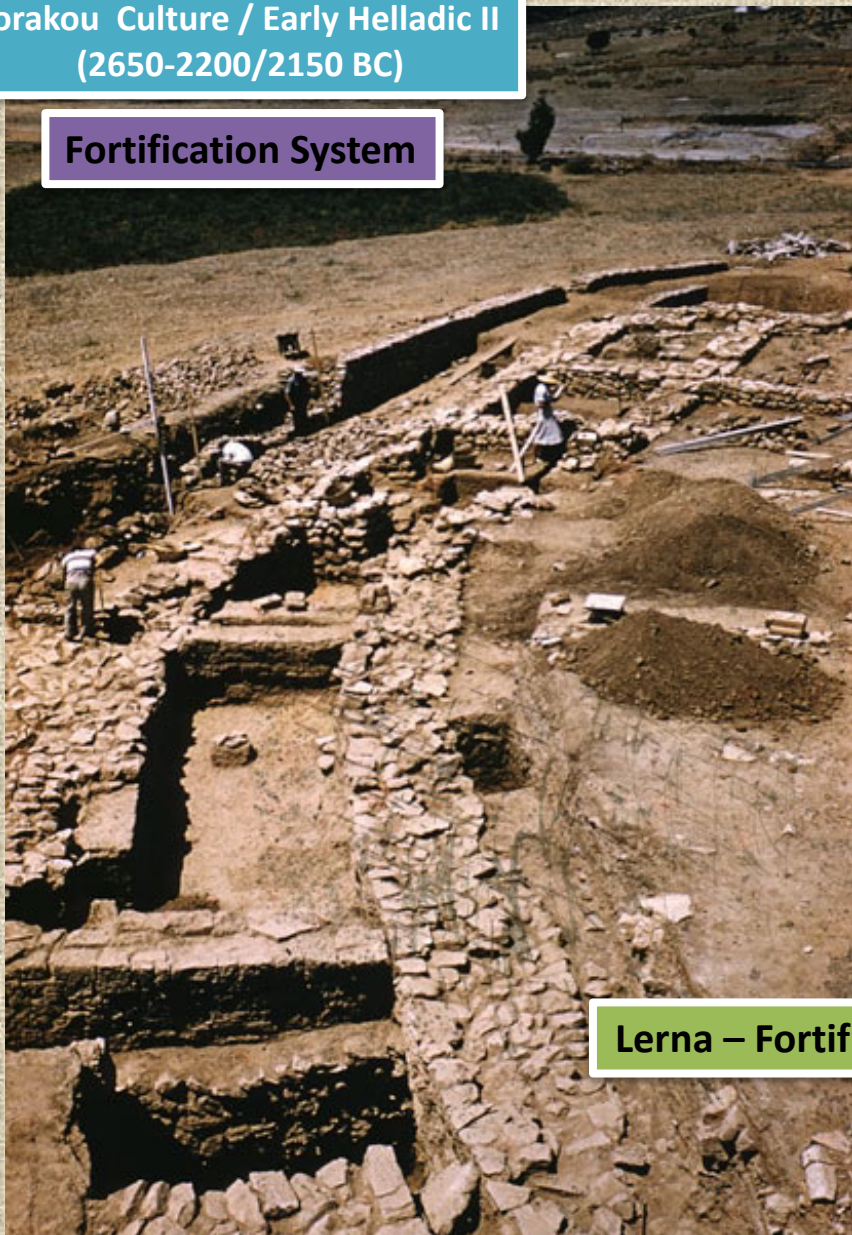

Lerna – Fortification Walls, EH II

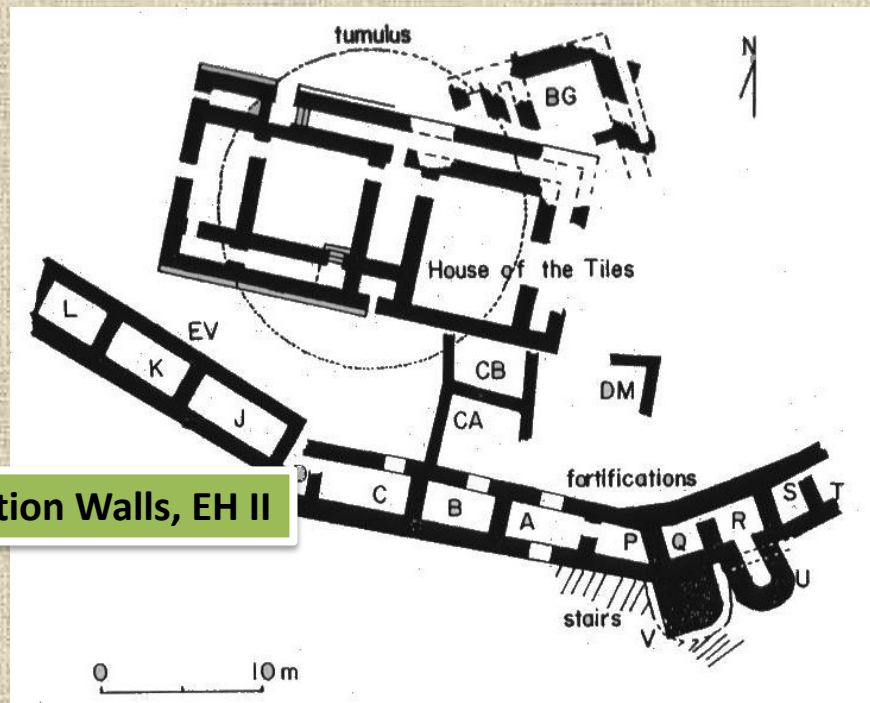

## Early Helladic Culture

Korakou Culture / Early Helladic II  
(2650-2200/2150 BC)

### Administrative Buildings

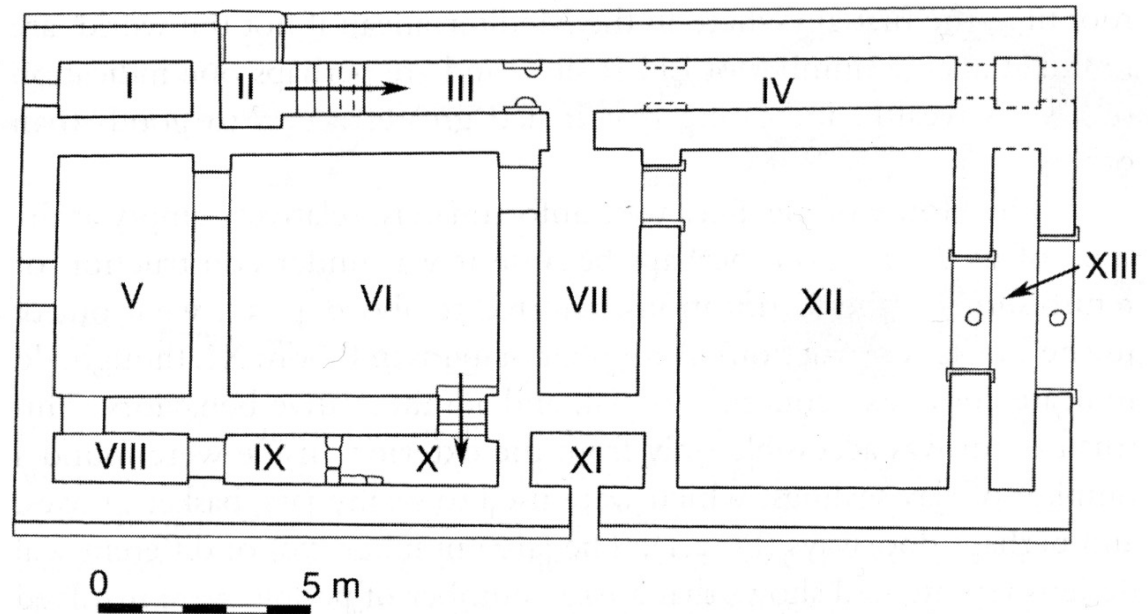

FIGURE 2.7. Plan of the House of the Tiles at Lerna, EH IIB. After M. H. Wiencke,

## Lerna – House of the Tiles EH II



## Early Helladic Culture

## Lerna – House of the Tiles EH II

Korakou Culture / Early Helladic II  
(2650-2200/2150 BC)

### Administrative Buildings

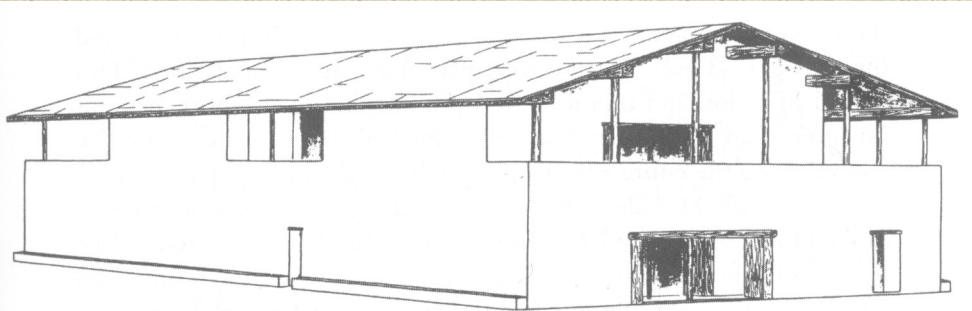

FIGURE 2.8. Reconstruction of the House of the Tiles at Lerna, EH IIB. M. H.

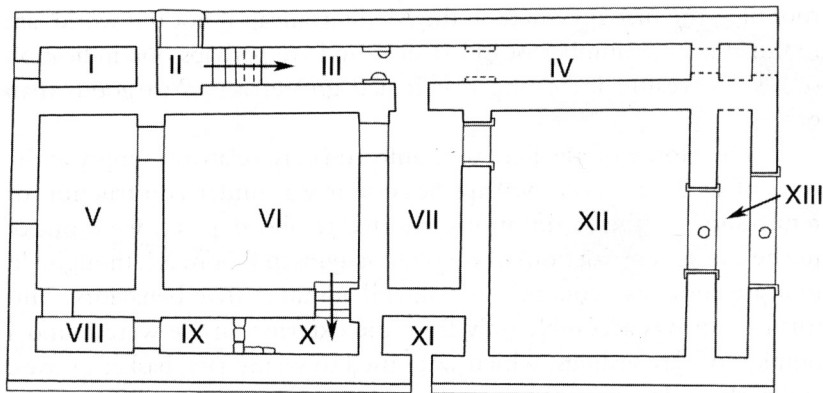

FIGURE 2.7. Plan of the House of the Tiles at Lerna, EH IIB. After M. H. Wiencke,



# Early Helladic Culture

Korakou Culture / Early Helladic II  
(2650-2200/2150 BC)

## Administrative Buildings



Tiles

# Lerna – House of the Tiles EH II



Tile





# Early Helladic Culture

# Lerna - House of the Tiles Seal Impressions EH II

Korakou Culture / Early Helladic II  
(2650-2200/2150 BC)

Administrative Buildings



79 a-f Drawings of six of the many clay seal-impressions found in the House of Tiles at Lerna. The favourite motives are geometrical, but occasionally spiders (c) or ritual vessels (f) were used. 79g is a photograph of one of these seal-impressions



RECONSTRUCTION 1

RECONSTRUCTION 2

Private Room

Private Room

B Lightwell

Gallery or Public Room

C Public Room

Clerestory

G Galleries (open to exterior)

Galleries

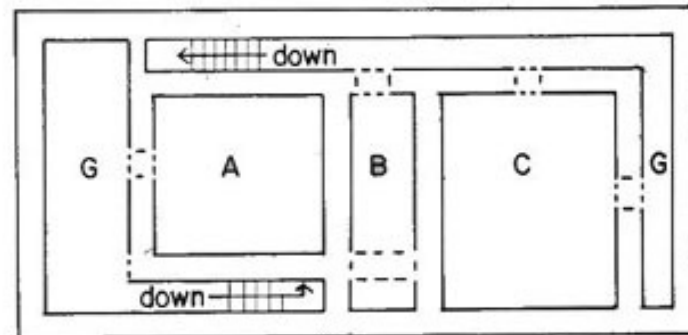

SECOND FLOOR

0 5m

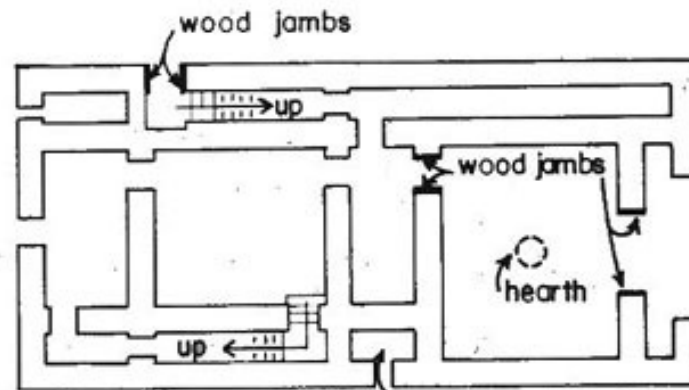

FIRST FLOOR

# Early Helladic Culture

Korakou Culture / Early Helladic II  
(2650-2200/2150 BC)

Administrative buildings

Lerna – House of the Tiles  
Seal Impressions  
EH II

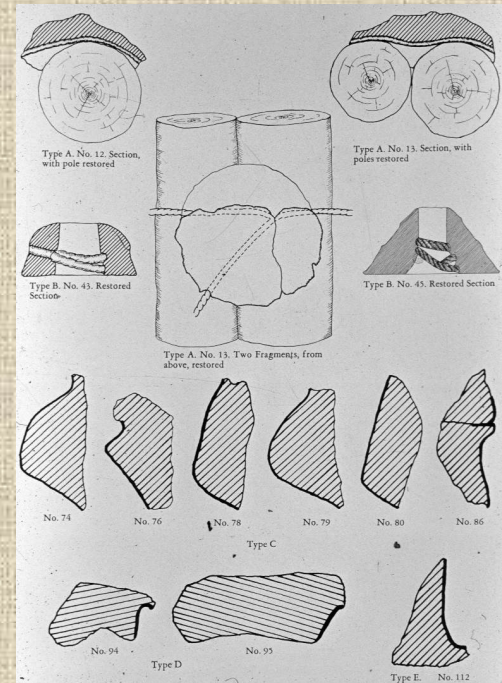
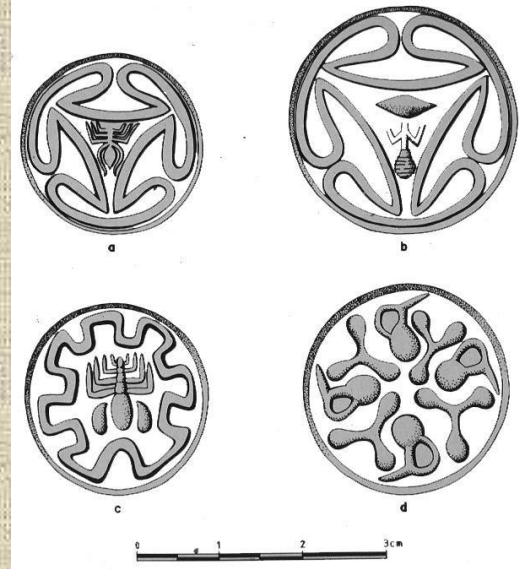

**Early Helladic Culture**

**Korakou Culture / Early Helladic II  
(2650-2200/2150 BC)**

**Administrative Buildings**

**Lerna - House of the Tiles  
Seal Impressions  
EH II**



**Lerna – House of the Tiles  
Seal Impressed Ceremonial  
Hearth  
EH II**

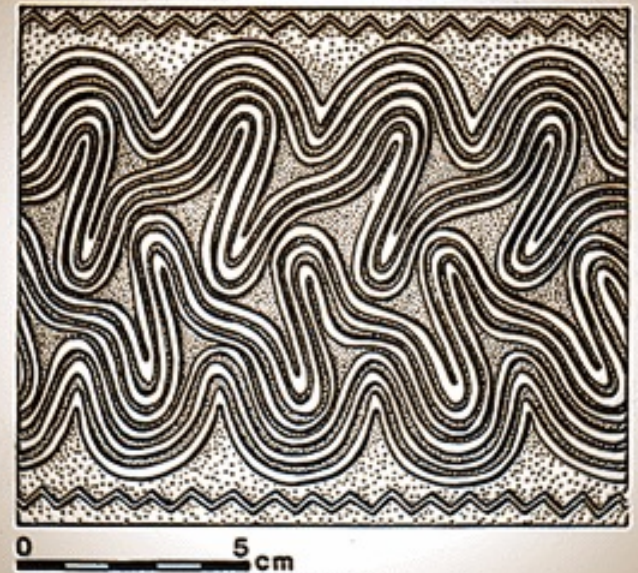

## Early Helladic Culture

## Tsepi Marathon – Early Helladic I (Late) Cemetery

Korakou Culture / Early Helladic II  
(2650-2200/2150 BC)

### Burial Habits



EH II cemeteries are usually extramural. There are always a variation of grave types.

Tsepi Marathon – Early Helladic I (Late) Cemetery

Early Helladic Culture

Korakou Culture / Early Helladic II  
(2650-2200/2150 BC)

Burial Habits

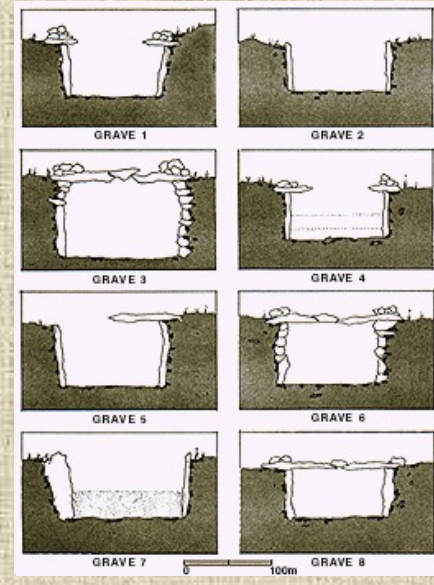
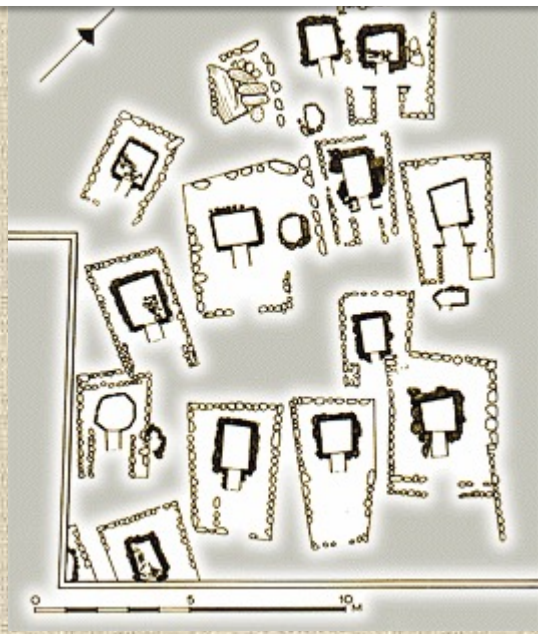

## Early Helladic Culture

Korakou Culture / Early Helladic II  
(2650-2200/2150 BC)

Tsepi – Marathon Cemetery  
Pottery and Marble Idol Finds

### Burial Habits



## Early Helladic Culture

Korakou Culture / Early Helladic II  
(2650-2200/2150 BC)

Burial Habits

Manika Cemetery



# Early Helladic Culture

Korakou Culture / Early Helladic II  
(2650-2200/2150 BC)

## Burial Habits

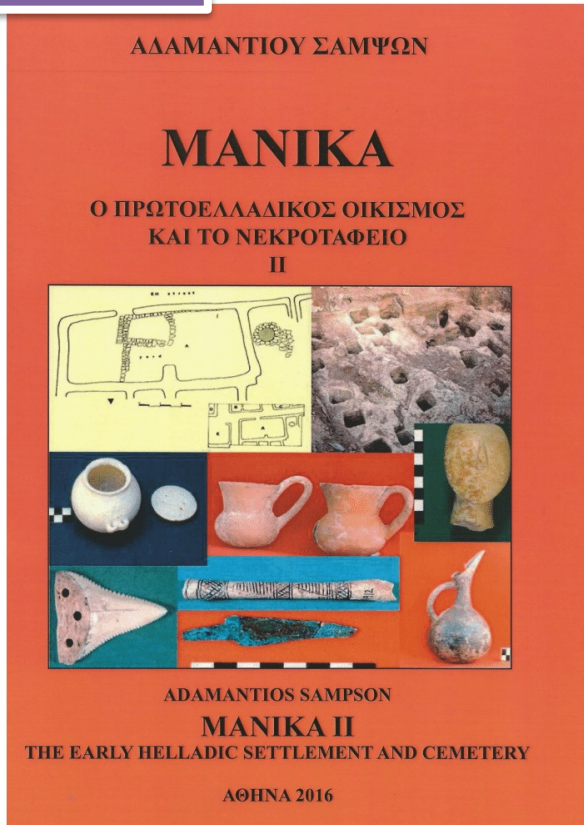

## Manika Cemetery Pottery and Small Finds





# Early Helladic Culture

Korakou Culture / Early Helladic II  
(2650-2200/2150 BC)

## Pottery

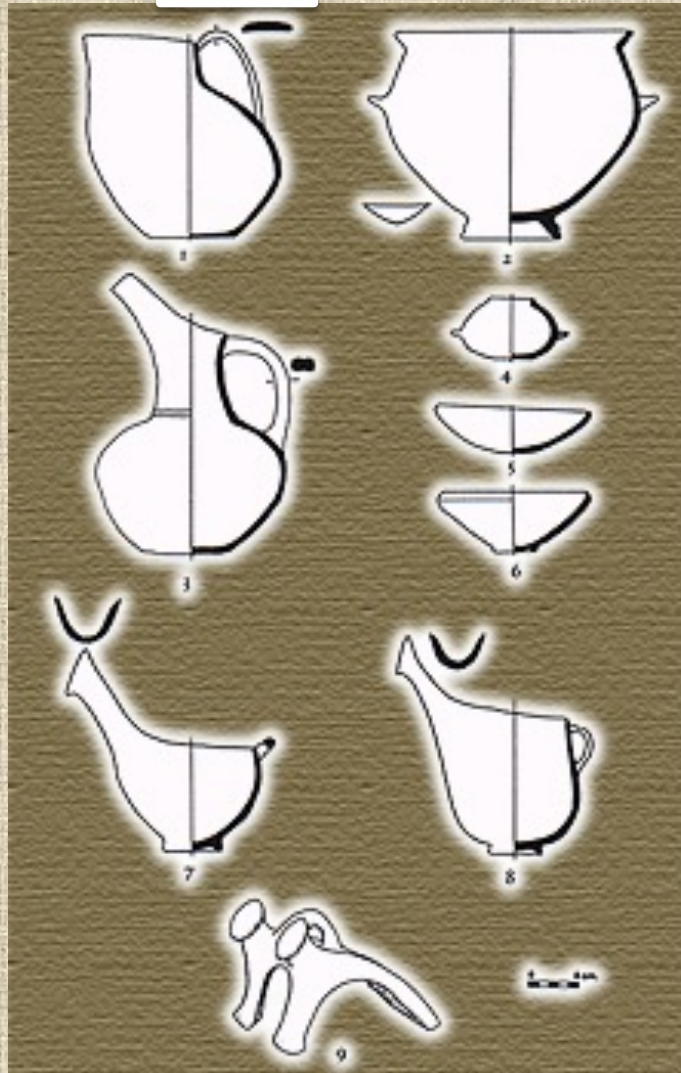

## Early Helladic II Main Pottery shapes

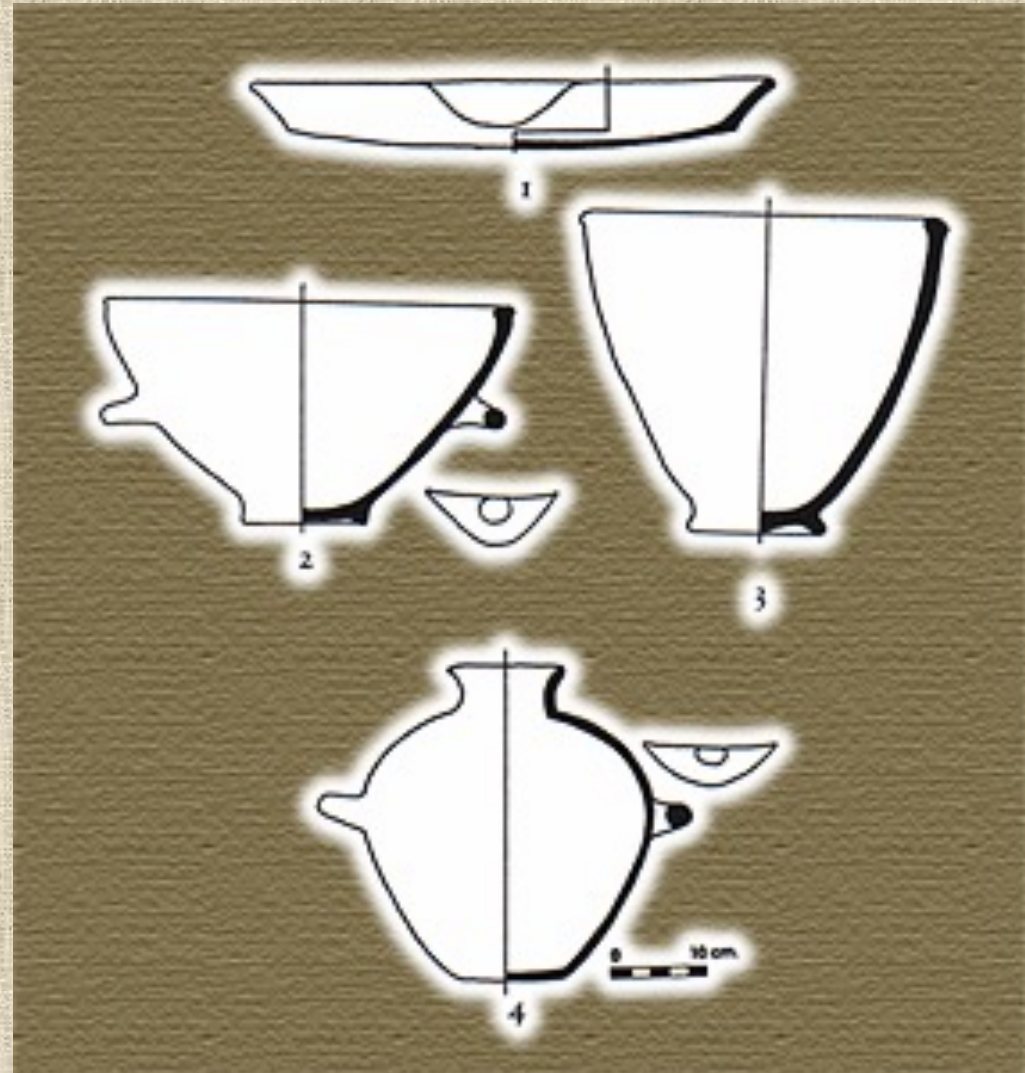

## Early Helladic Culture

Korakou Culture / Early Helladic II  
(2650-2200/2150 BC)

Pottery



## Urfirnis Sauceboats



## Early Helladic Culture

Korakou Culture / Early Helladic II  
(2650-2200/2150 BC)

Pottery



# Early Helladic Culture

## Urfirnis Sauceboats

Korakou Culture / Early Helladic II  
(2650-2200/2150 BC)

Pottery

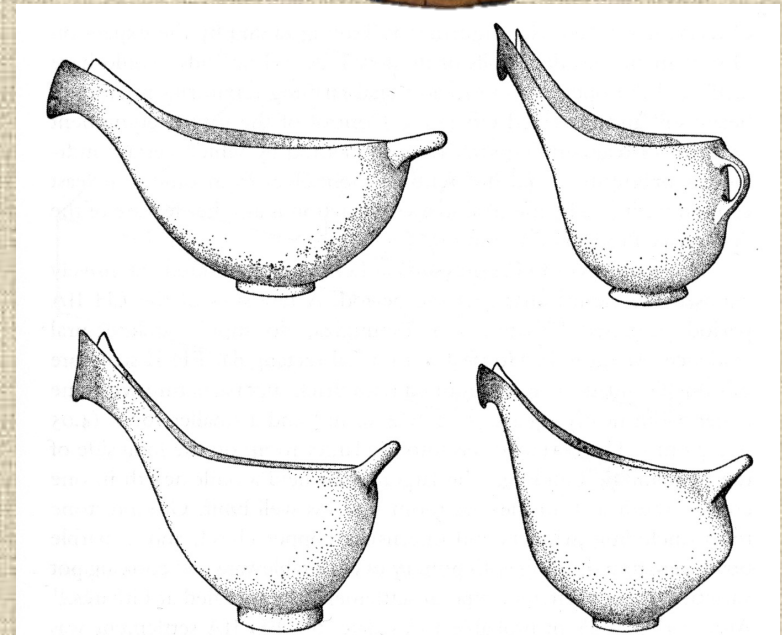
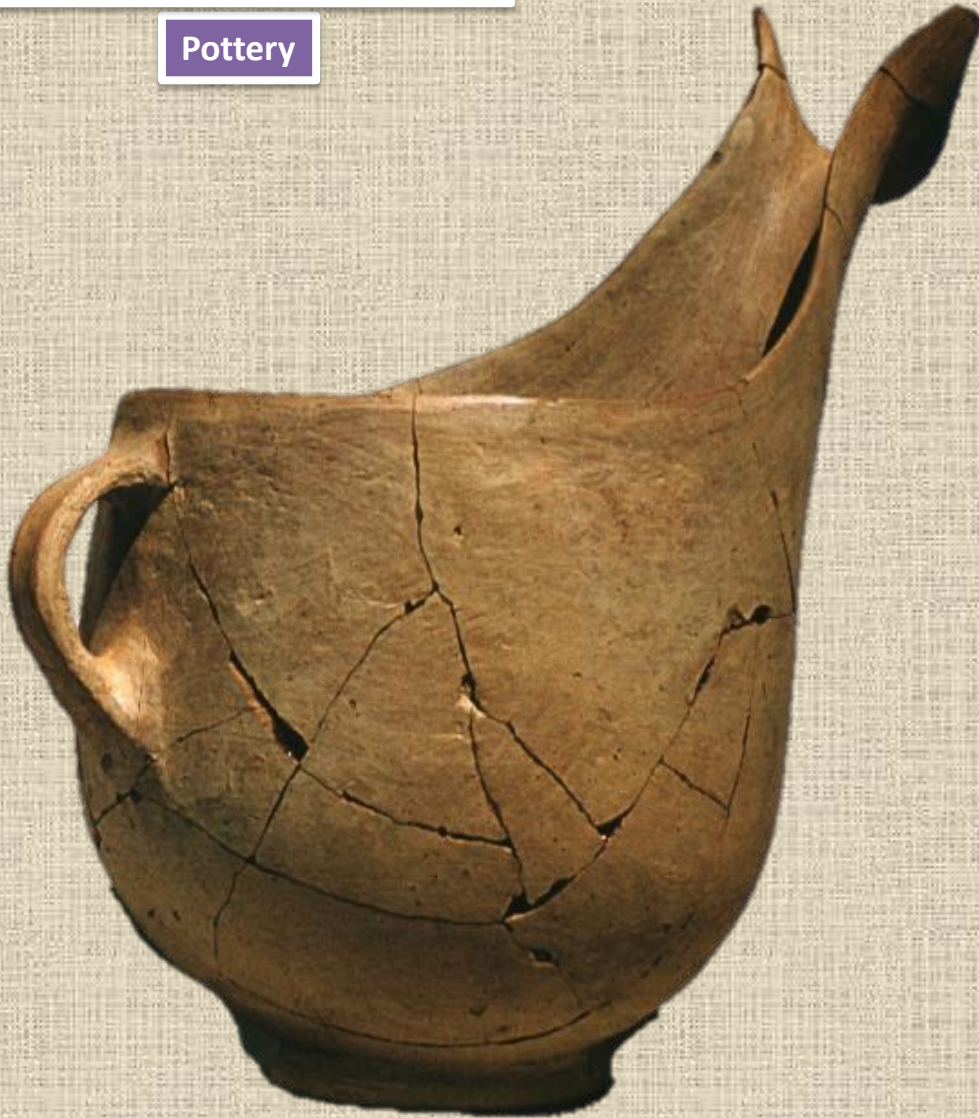

FIGURE 2.3. Sauceboats from Lerna, EH II. J. L. Caskey, "The Early Helladic

## Early Helladic Culture

Korakou Culture / Early Helladic II  
(2650-2200/2150 BC)

Pottery



# Early Helladic Culture

Korakou Culture / Early Helladic II  
(2650-2200/2150 BC)

Pottery

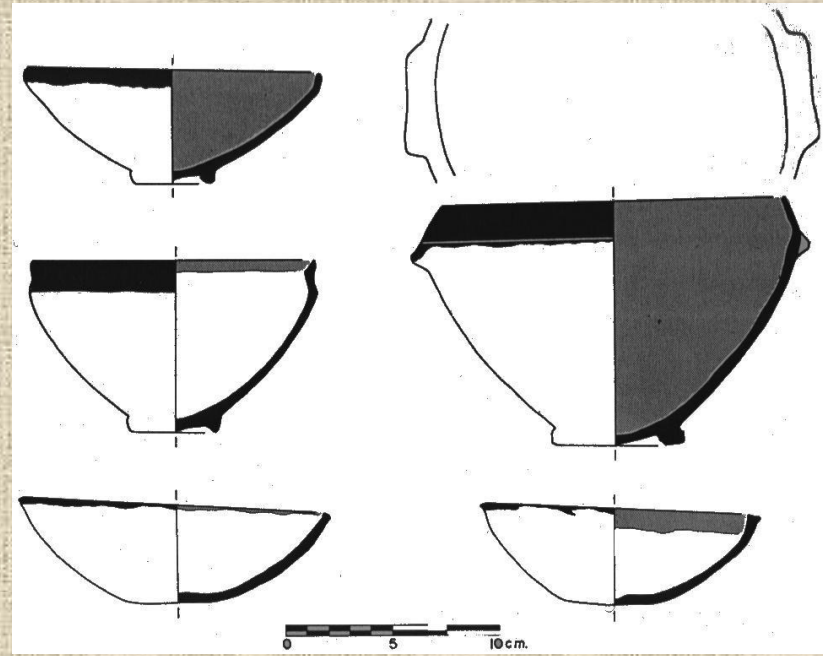

Tsoungiza

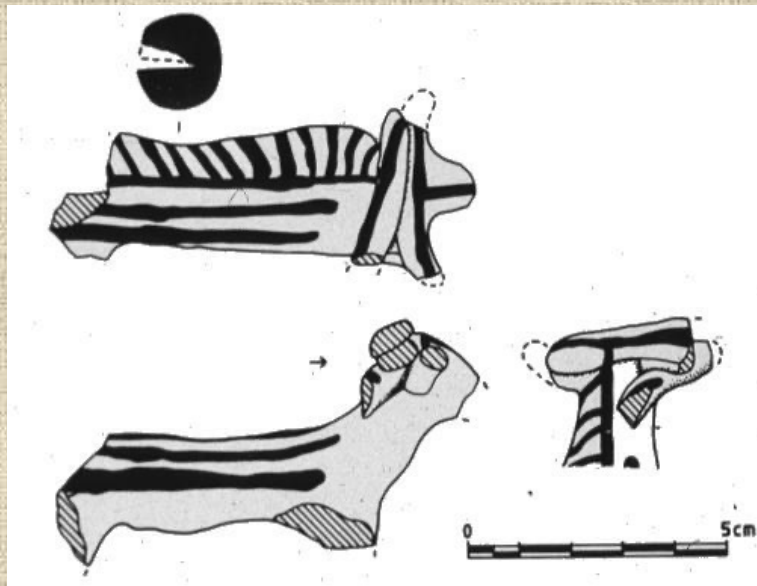

Tsoungiza, Cow Figurine

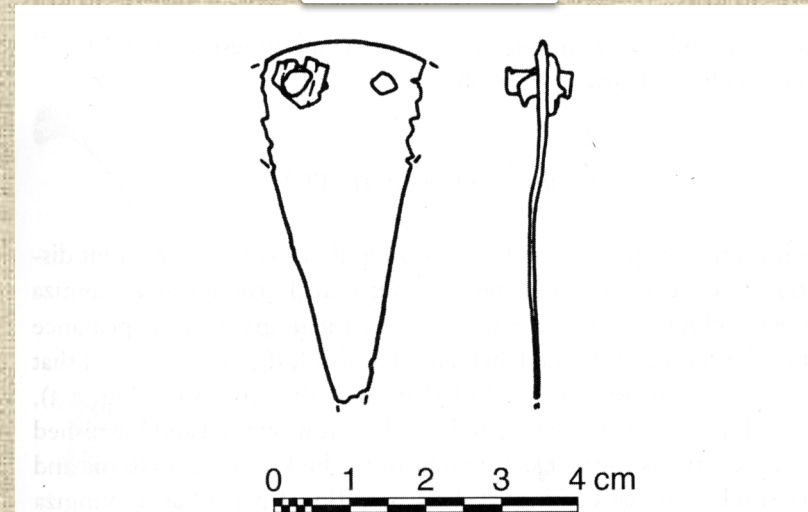

FIGURE 2.2. Dagger from Tsoungiza, EH I-II Early. Drawing by Julia E. P. Courtesy of the author.

# Early Helladic Culture

Lefkandi I / Early Helladic II (Late)  
(2400-2200/2150 BC)

Pottery

Aegina, Anatolianizing  
Shapes

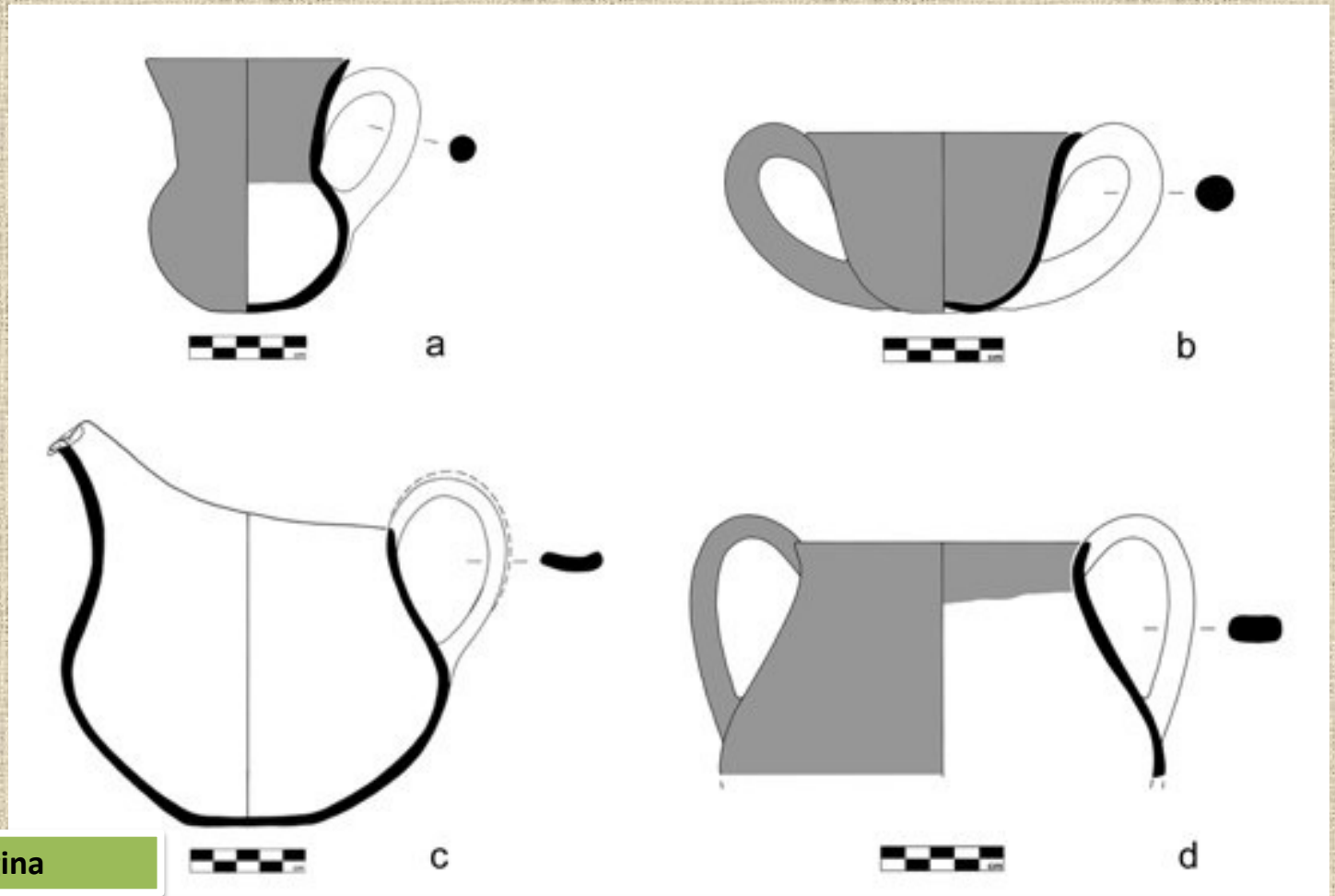

Aegina

Abb.: FH II-zeitliche Gefäße der Phase 2: Trichterhalskrug (a), Glockentasse (b), bauchige Schnabeltasse (c) und Humpen (d) (Zeichnungen L. Berger)

**Early Helladic Culture**

**Lefkandi I / Early Helladic II (Late)  
(2400-2200/2150 BC)**

**Pottery**

**Aegina, Anatolianizing  
Pottery - Tankard**





## Early Helladic Culture

Lefkandi I / Early Helladic II (Late)  
(2400-2200/2150 BC)

Pottery

Aegina, Anatolianizing  
Pottery – Bell Shaped Cup



# Early Helladic Culture

Tiryns / Lerna IV / Early Helladic III  
(2400-2000 BC)

## Settlement Architecture

## Lerna, Apsidal Planned Buildings

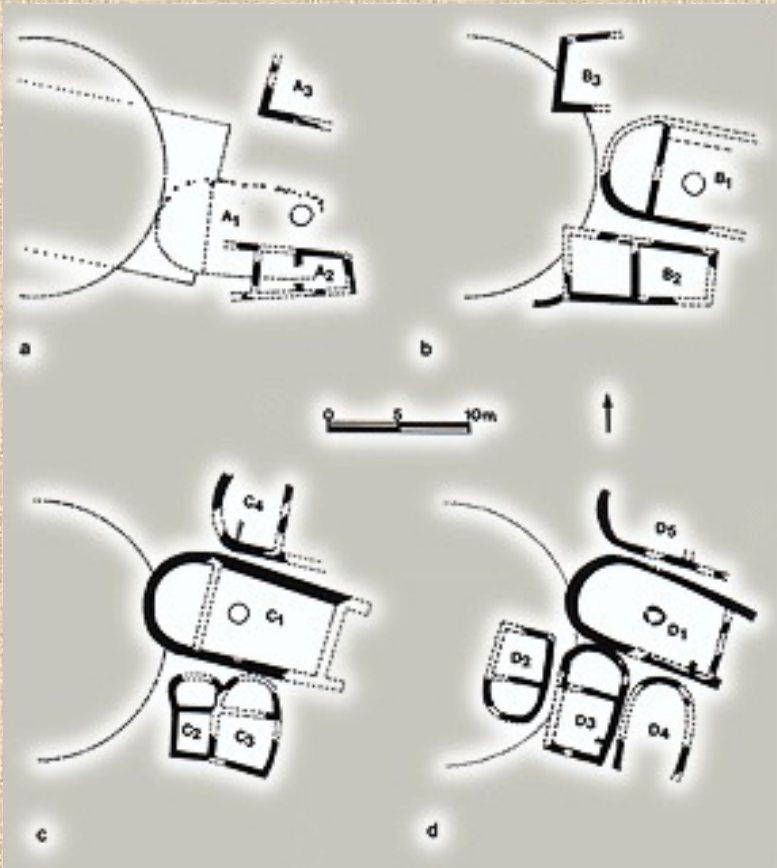

# Early Helladic Culture

Tiryns / Lerna IV / Early Helladic III  
(2400-2000 BC)

## Pottery

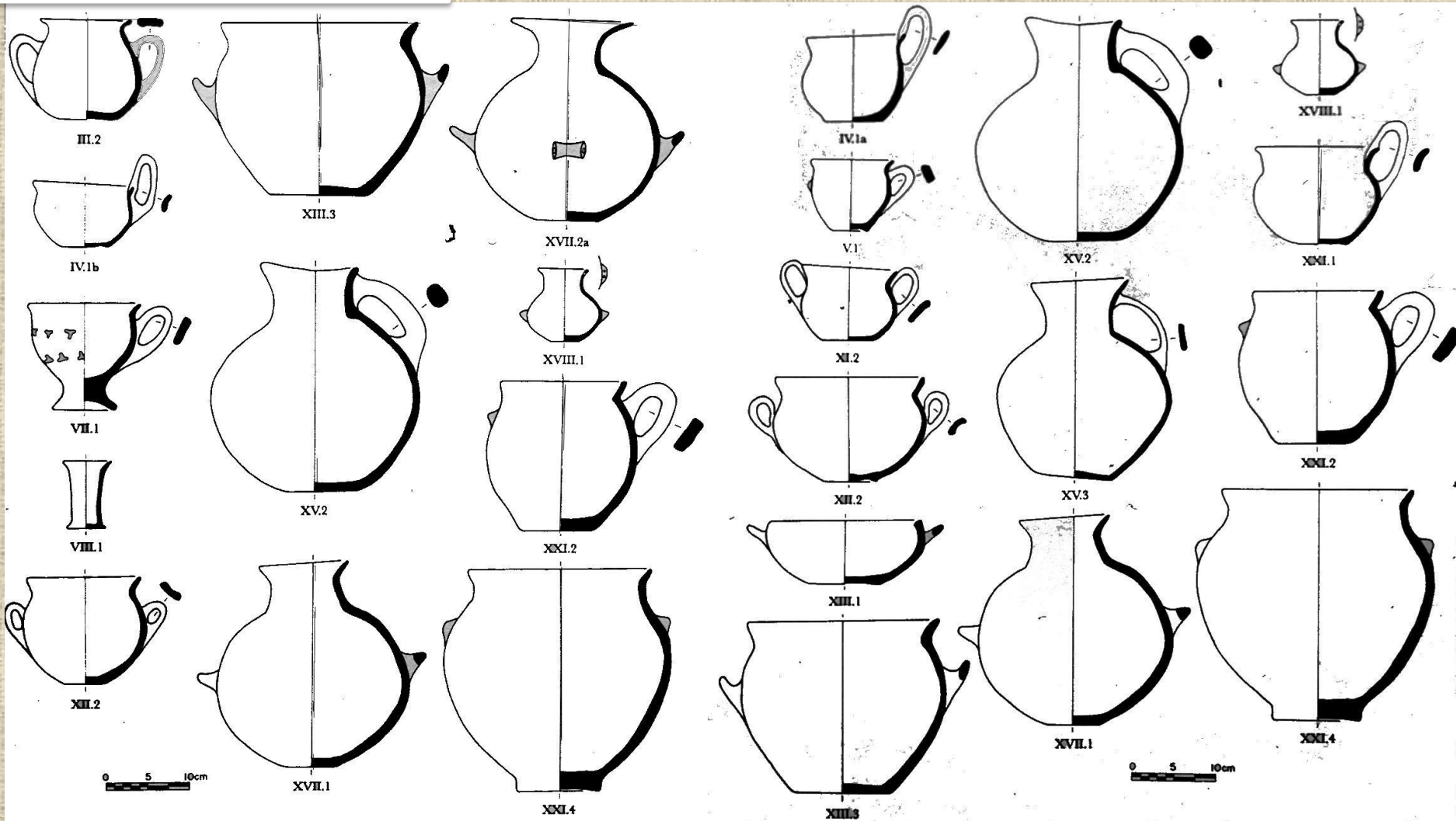

Lerna IV, Phase 2 Pottery

Lerna IV, Phase 3 Pottery

**Early Helladic Culture**

**Lerna IV Pottery  
Fine Gray Burnished Ware**

Tiryns / Lerna IV / Early Helladic III  
(2400-2000 BC)

Pottery



# Early Helladic Culture

Tiryns / Lerna IV / Early Helladic III  
(2400-2000 BC)

Pottery



Lerna IV Pottery



## Early Helladic Culture

Tiryns / Lerna IV / Early Helladic III  
(2400-2000 BC)

Pottery



Lerna IV Pottery



# Early Helladic Culture

Tiryns / Lerna IV / Early Helladic III  
(2400-2000 BC)

Seramik



Lerna IV Seramiği

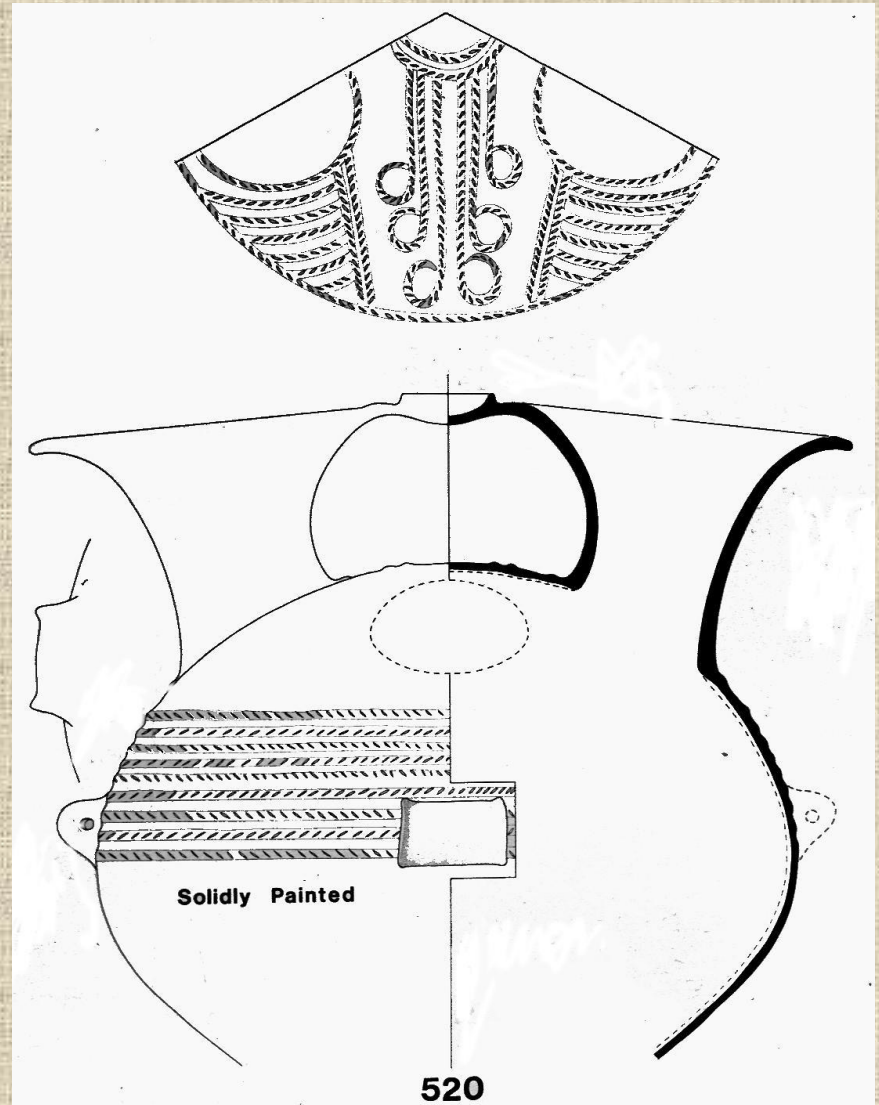

## Early Helladic Culture

Tiryns / Lerna IV / Early Helladic III  
(2400-2000 BC)

Pottery

Lerna IV Pottery





## Early Helladic Culture

Tiryns / Lerna IV / Early Helladic III  
(2400-2000 BC)

### Pottery



### Aegina, EH III Pottery

