

LİFLERİN MEKANİK ÖZELLİKLERİ

KUVVET TÜRLERİ

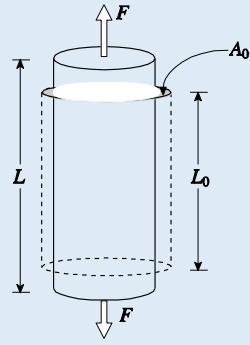

çekme

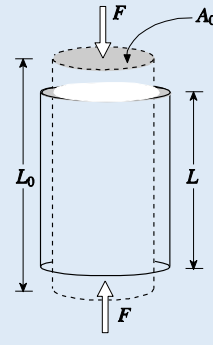

sıkıştırma

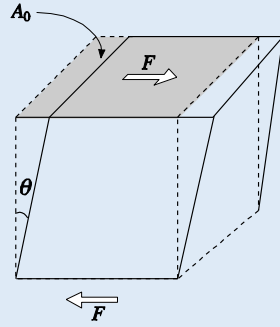

kayma

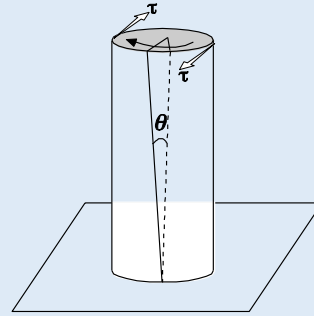

burma

DEFORMASYON GERİLİM ve GERİNİM

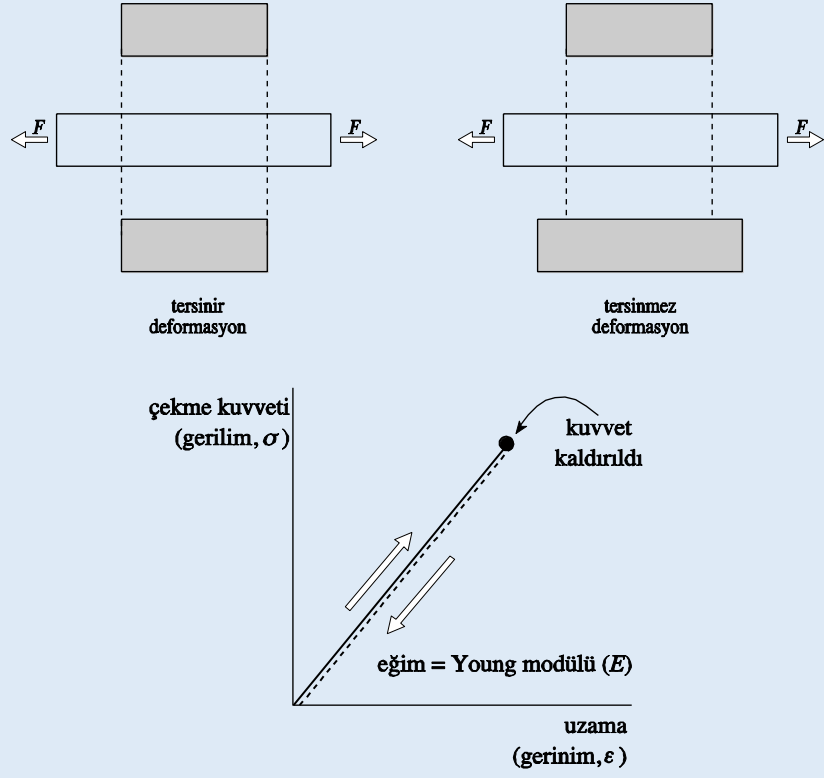

4.6 VİSKOELASTİK DEFORMASYON

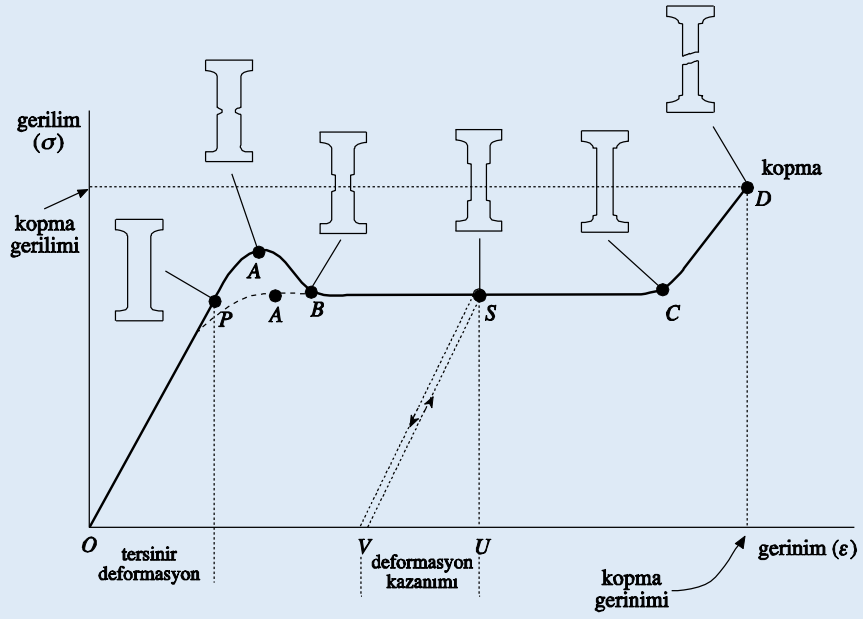

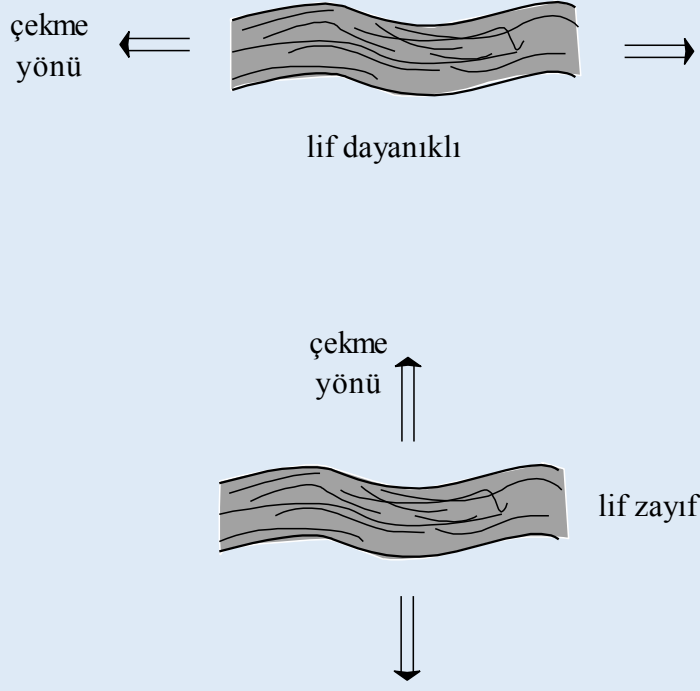

LİFLERDE KARŞILAŞILAN GERİNİM-GERİLİM EĞRİLERİ

