

Koparma

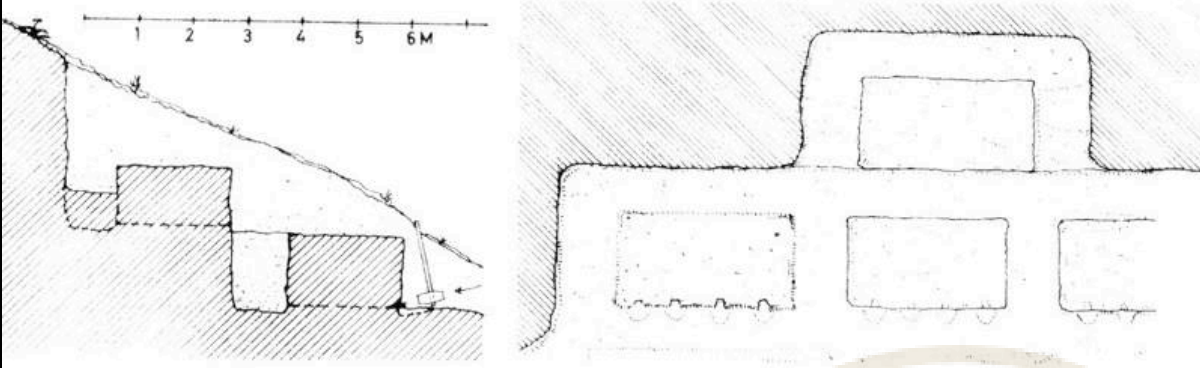

Res. 26. Üç tarafta kanalların blok yüksekliğinde açılmasından sonra, sıra bloğun altını kesmeye geldiğinde bu işlem, ya metal, ya da ahşap kamalarla gerçekleştiriliyordu. (Müller-Wiener, Abb. 12a)

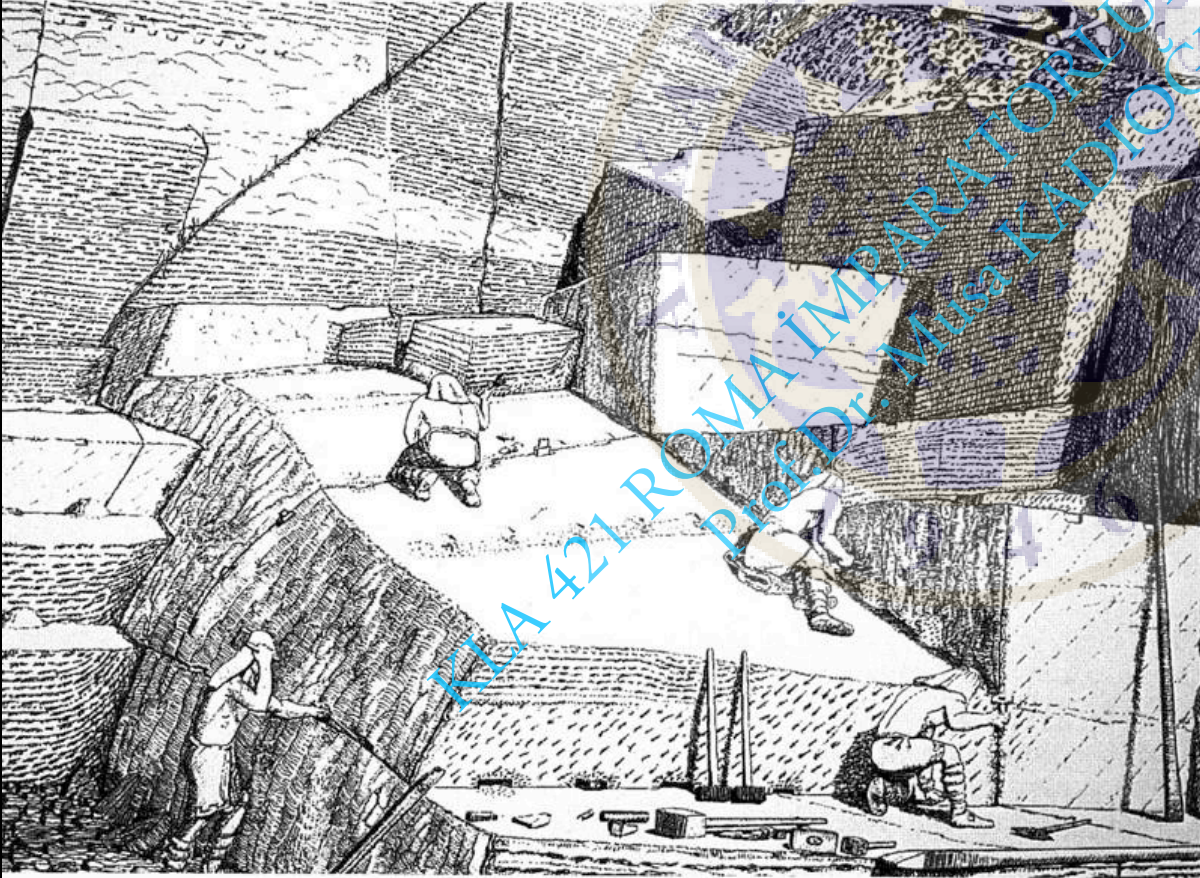

Res. 27. Ya da tüm işlem kanalsızın yapılarak bloklar kamalarla kopartılıyordu. (Korres, Pentali, Abb. 15)

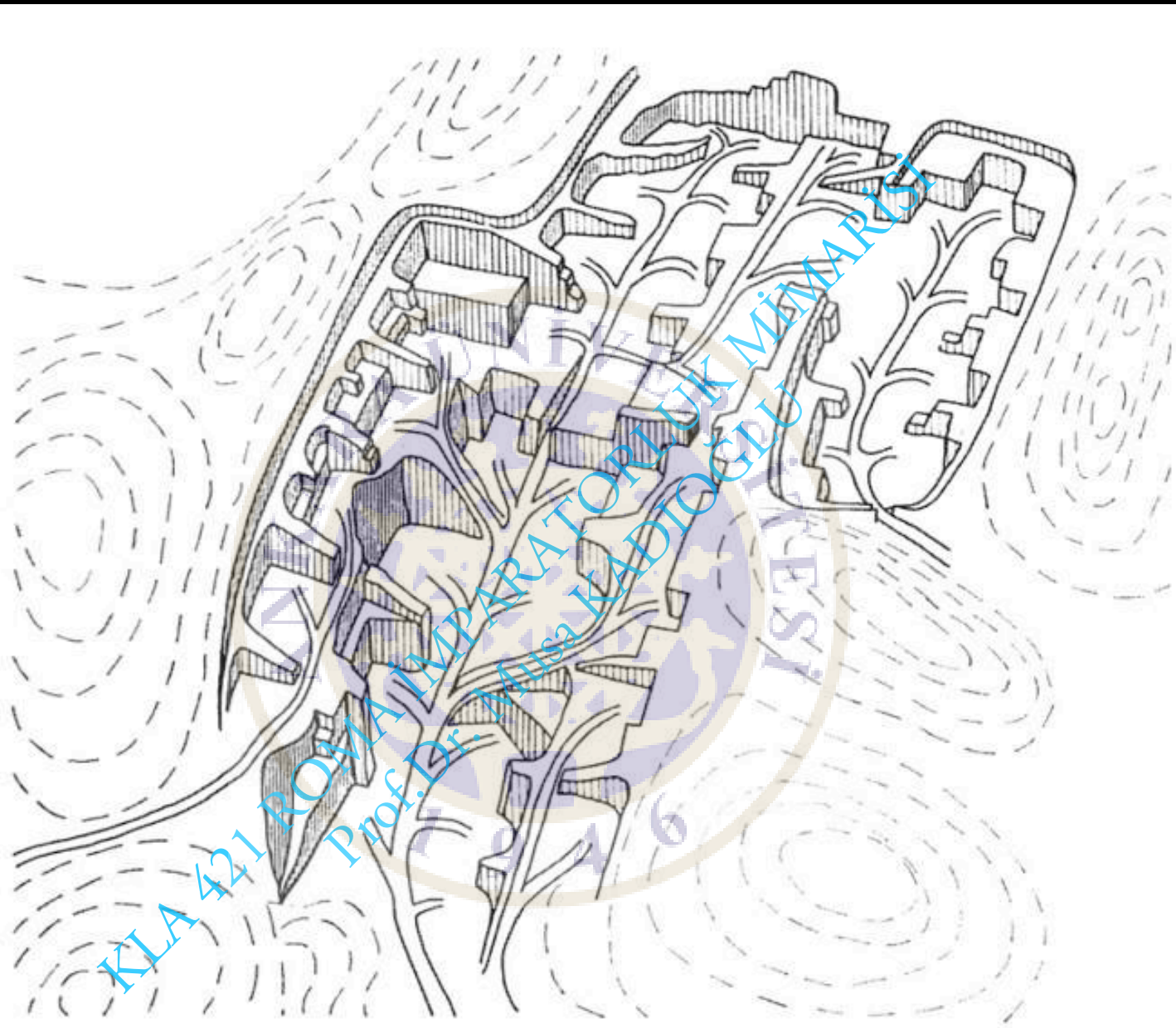

Res. 34. Dokimeion, Bacakale ocağı. Yamaca sıralar ve teraslar halinde açılmış ocaklar (Röder, Abb. 14).

Koparma ve Kesme

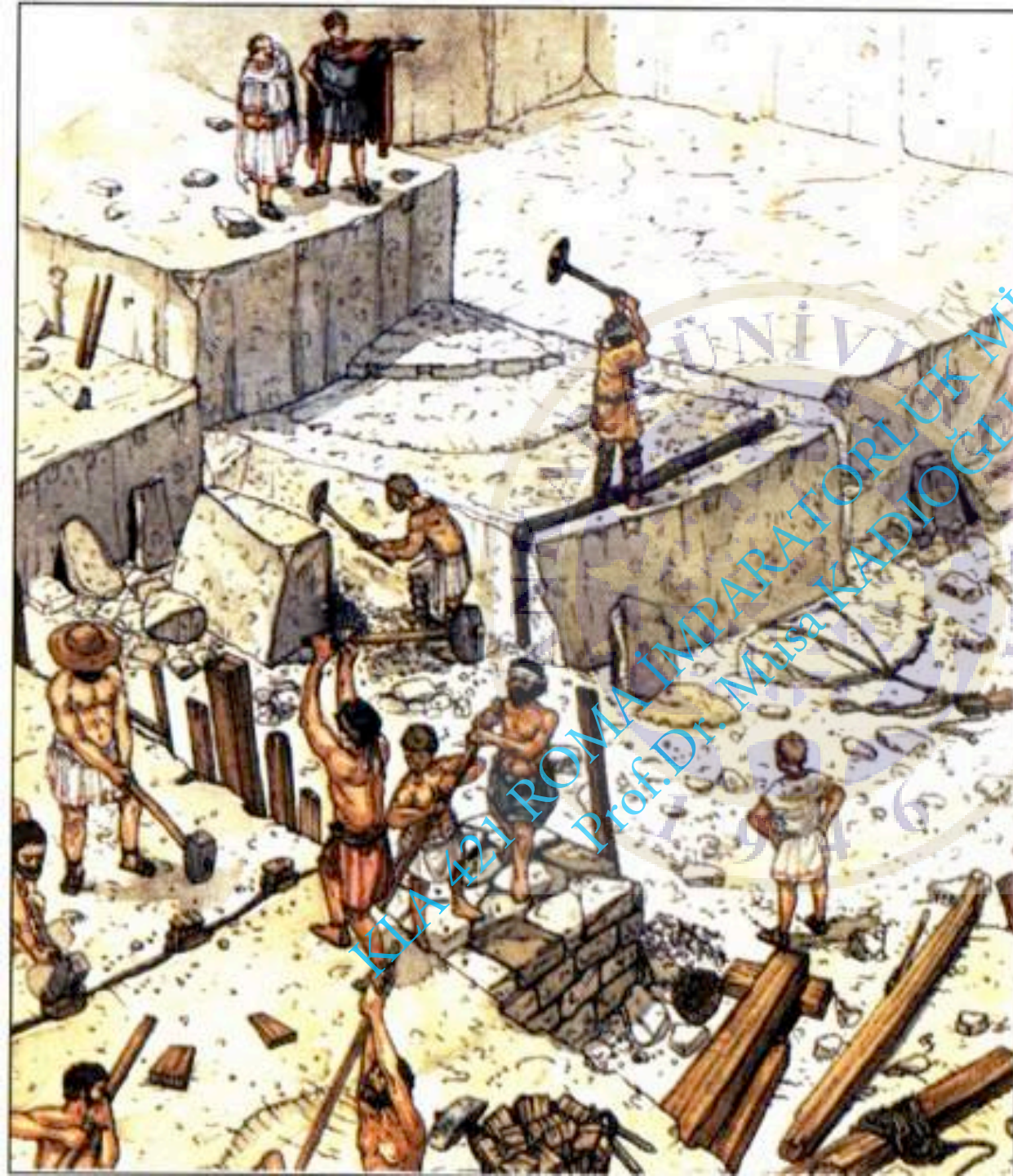

Testere İle Kesme

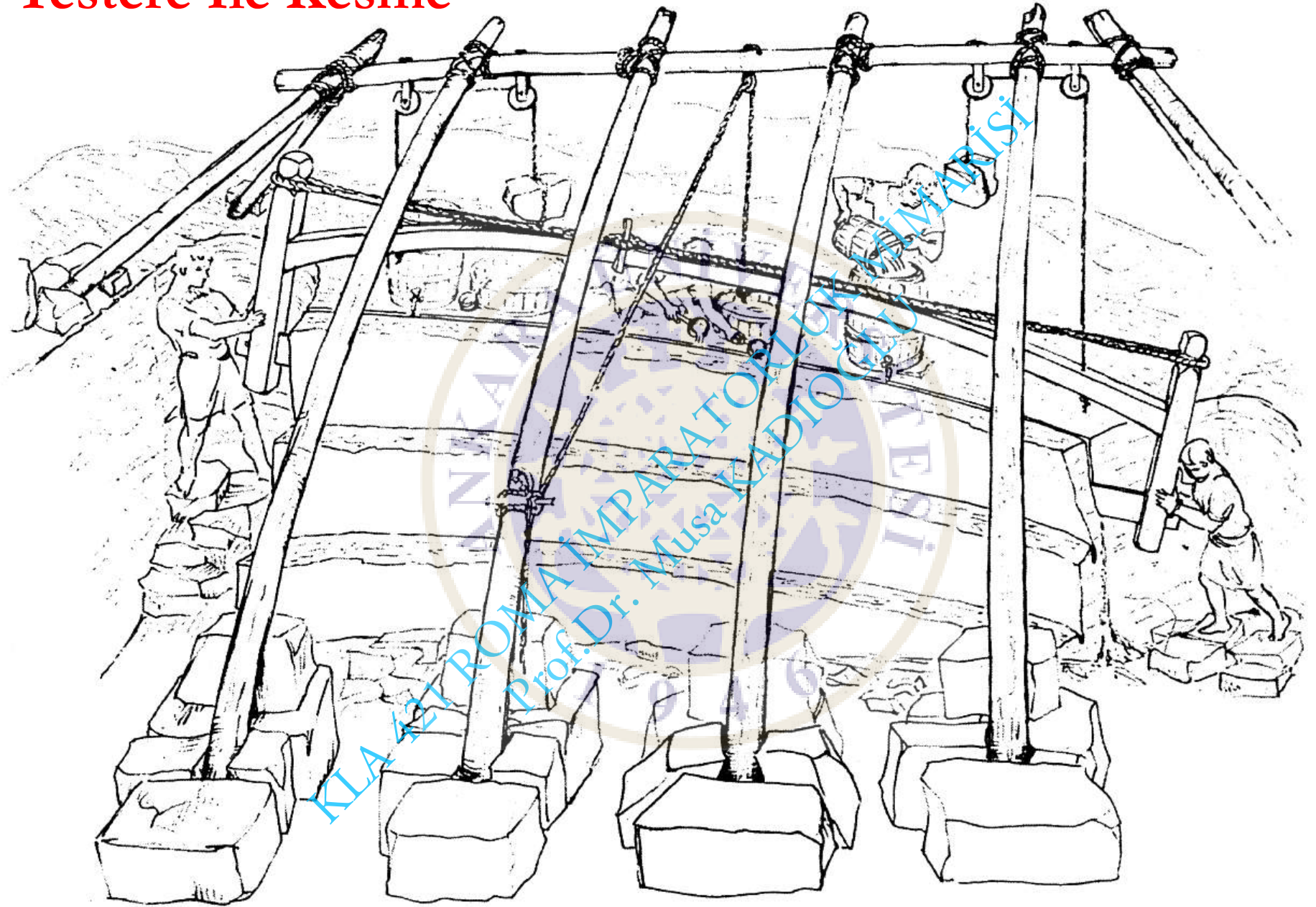

Res. 216. Röder'e göre testere kullanımı (Röder Abb. 64).



Res. 35. Kuşini Ocağı'nın içindeki destekler.

iki destek bırakılarak kullanılmış olması karşısında şaşkınlığımız yineleniyor. Bunun nedeni mermerin sağlam, çatlaksız ve firesiz olması olsa gerek. Ephesos Artemis Tapınağı'nın arşitravlarında kullanılmış olması da bunun diğer bir kanıtını oluşturuyor.

Ocaklarda mermere, oluşturacakları yapı elemanlarının kaba formları verilir. Bunun amacı, taşınacak yükün ağırlığını azaltmak olduğu kadar, taştaki olası bir hatanın ortaya çıkmasını da sağlamaktır. Taştaki bir hata varsa bunun özellikle taşın "taşıyan" bölümlerinde olmamasına dikkat edilir.



Res. 36. Kapalı ocaktan taş çıkarılmasına ilişkin varsayım (JPA 21).



Res. 21. Kuşini Ocağı'nın içinden bir görünüş.

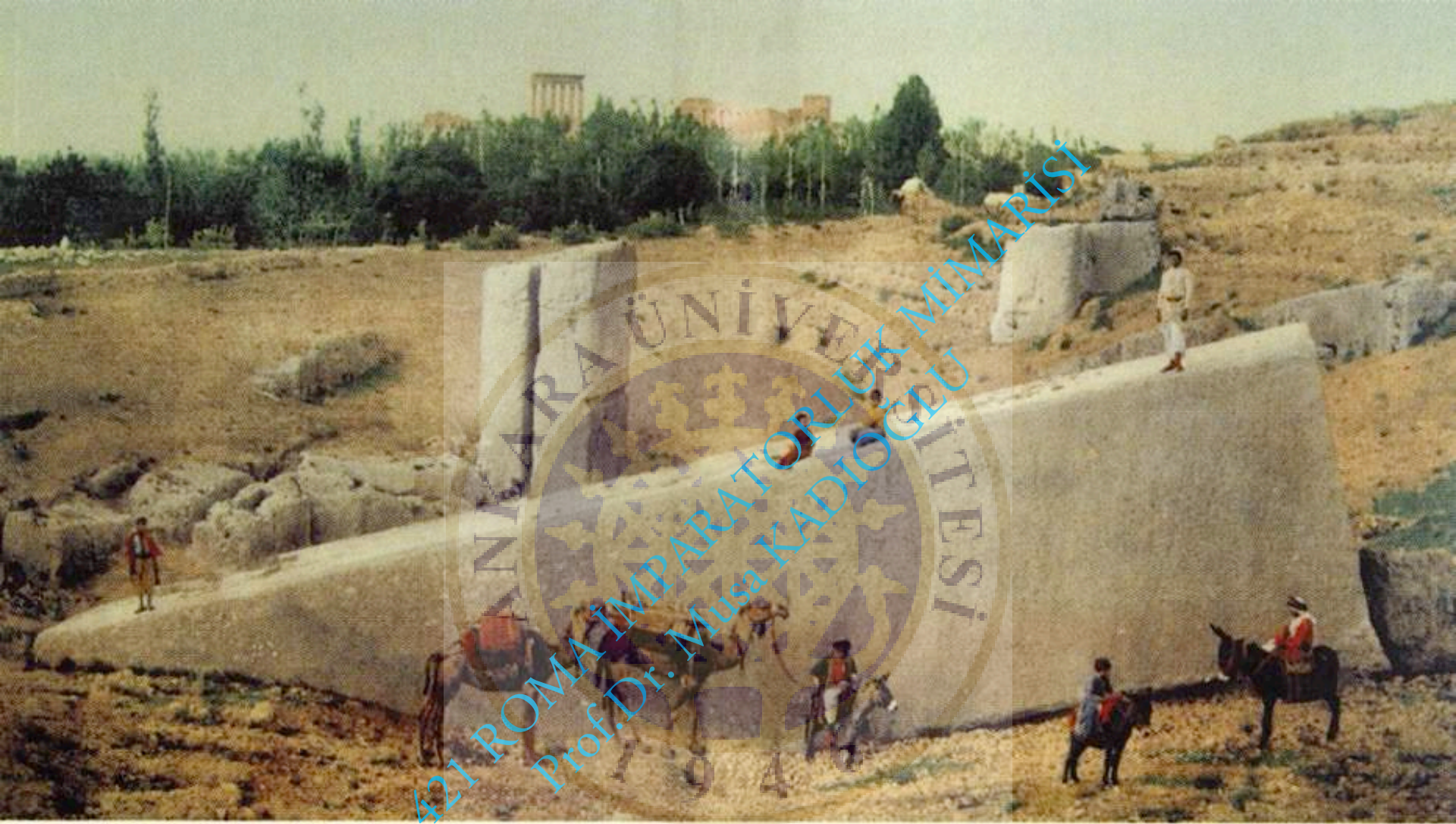

Res. 19. Hadschar el hibla, “gebe taşı” denilen bloğu belki de “doğan taş” olarak isimlendirmek daha uygun olacaktır (von Ess - T. Weber, iç kapak).



Res. 58. Baalbek Jüpiter Tapınağı'nın istinat duvarının podyumunda kullanılan üç büyük bloktan biri. Aşağıdaki insanın boyu ile karşılaştırılınca boyutunun büyüklüğü daha fazla anlaşılıyor (Ahmed Cemal Paşa, Abb. 69).

□ 12 Ein Kapitell wird per Lastzug und Holzschienen aus dem Steinbruch herabgelassen.

Blokların Ocaktan Taşınması

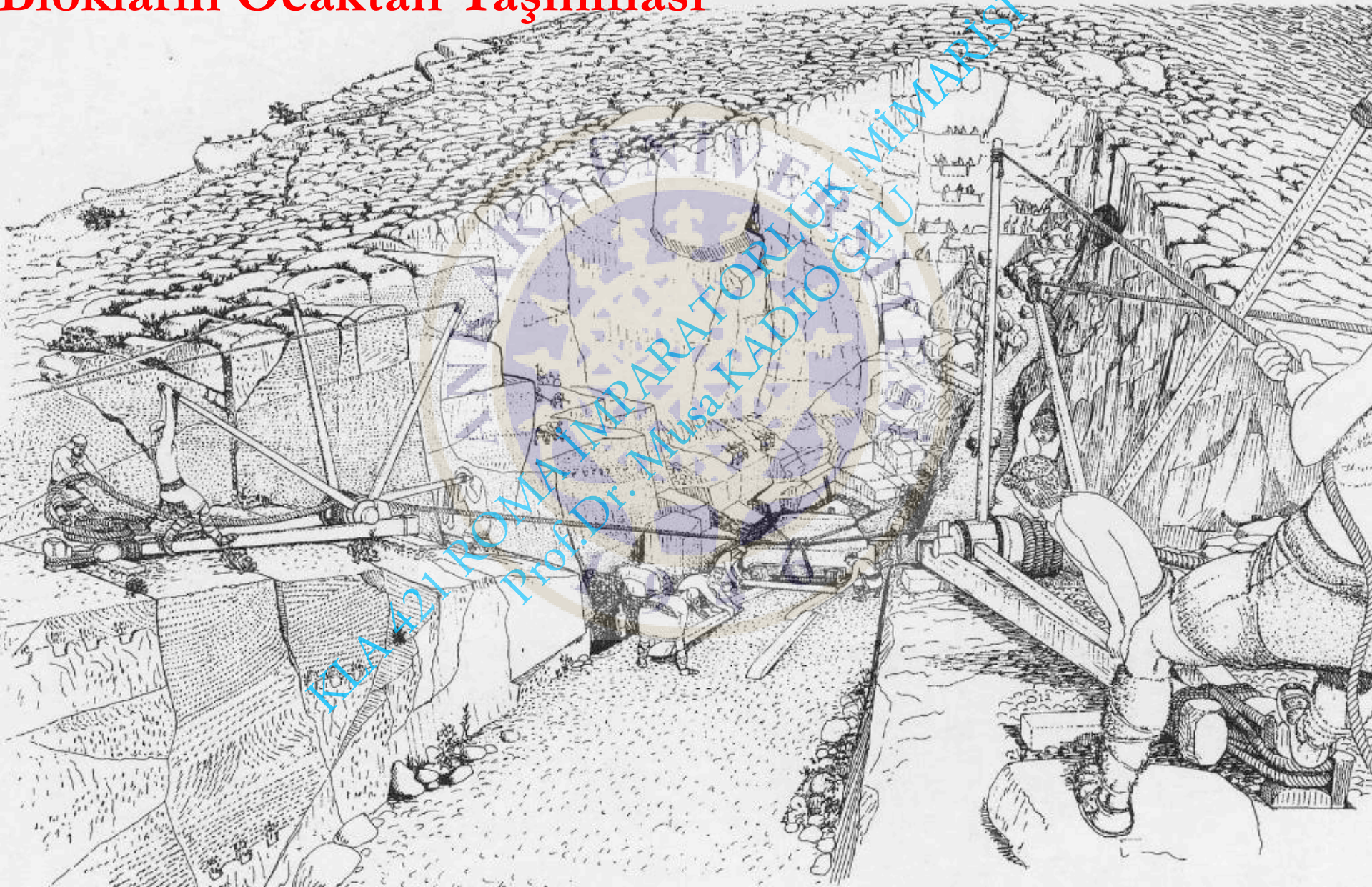



Res. 53. Üstteki örnekteki kızak artık düzgün bir yolda çekilmektedir. Ayrıca, halatlar, kızığın geriye kaymasını engellemek için yolun kenarındaki babalara sarılarak gücün kaybolmasını engellemekte, çekenlerin soluklanmasına olanak vermektedir. (Korres, Pentali, 31)

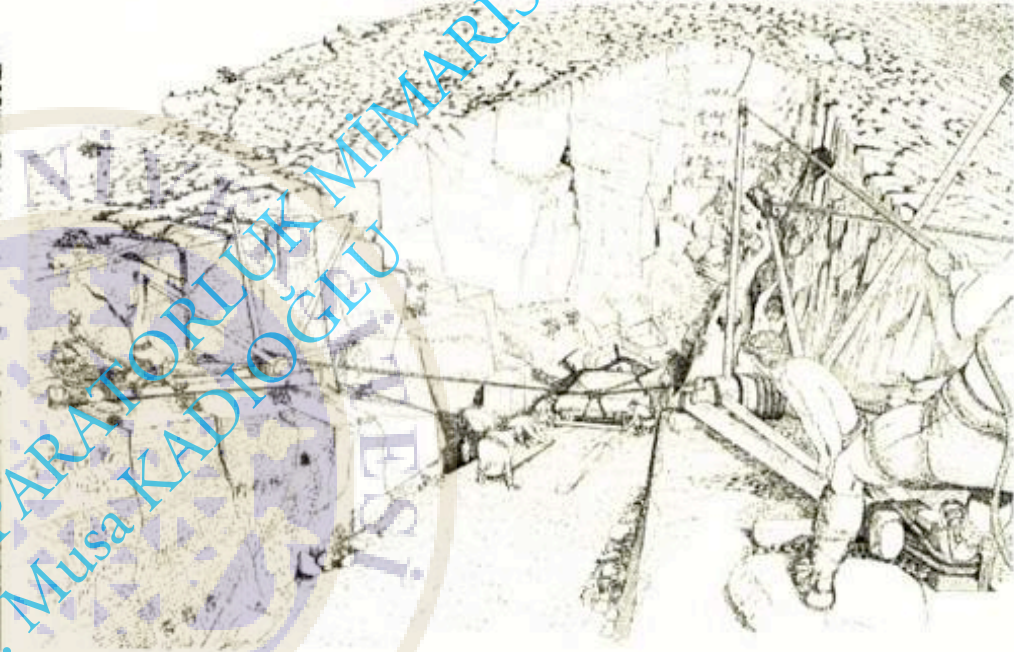

Res. 54. Bu varsayımda kızığın yola sürtünmesini azaltmak ve böylece daha az güç harcanmasını sağlamak için kızığın altına yolun kenarına paralel ahşaplar yerleştirilmiş, ayrıca iki taraflı bocurgatlarla çekme işlemi çok daha kolaylaştırılmıştır. Bu uygulamanın çalışan işçi sayısının azalmasına yararı olduğu görülüyor (Korres, Pentali, 29).



Res. 52. Kızaklar üzerinde taşımaya ilişkin varsayım.
(Di Giovanni, s. 28)

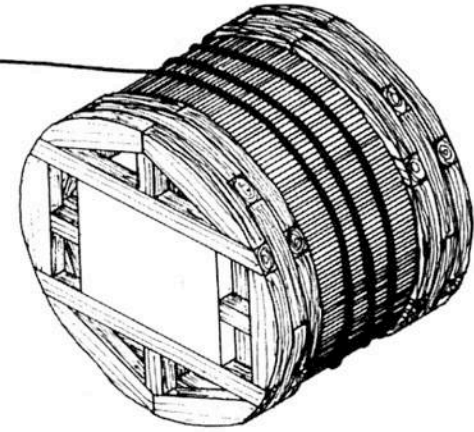

Res. 61. Paconius'un yöntemine göre blokların taşınması (Coulton, Architects Fig. 62).

KLA 421 ROMA İMPARATORLUK MİMARİSİ
Prof. Dr. Mustafa KADIOĞLU

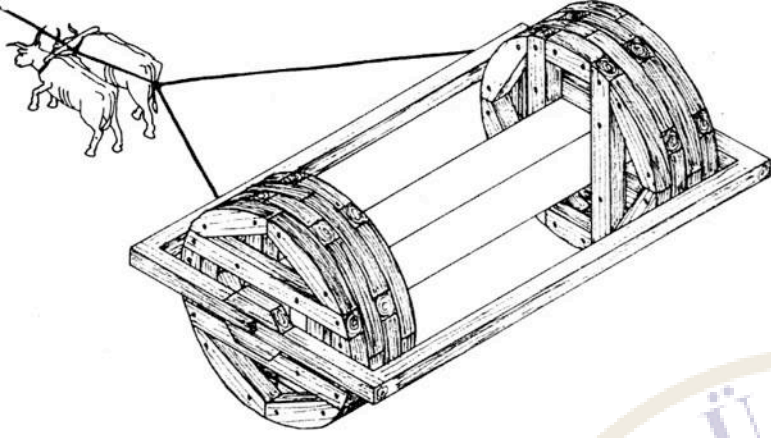

Res. 62. Metagenes'in metoduna göre blokların taşınması (Coulton, Architects Fig. 62).

ARABAYLA TAŞIMA

Zamanla ve doğal olarak, sadece bir kez kullanımı olan bu uygulamaları terk ederek, tekerleklerin bir taşıyıcı ile birleştirildiğinde ortaya çıkan arabalarla taşımaya geçildi.

VARSAYIM

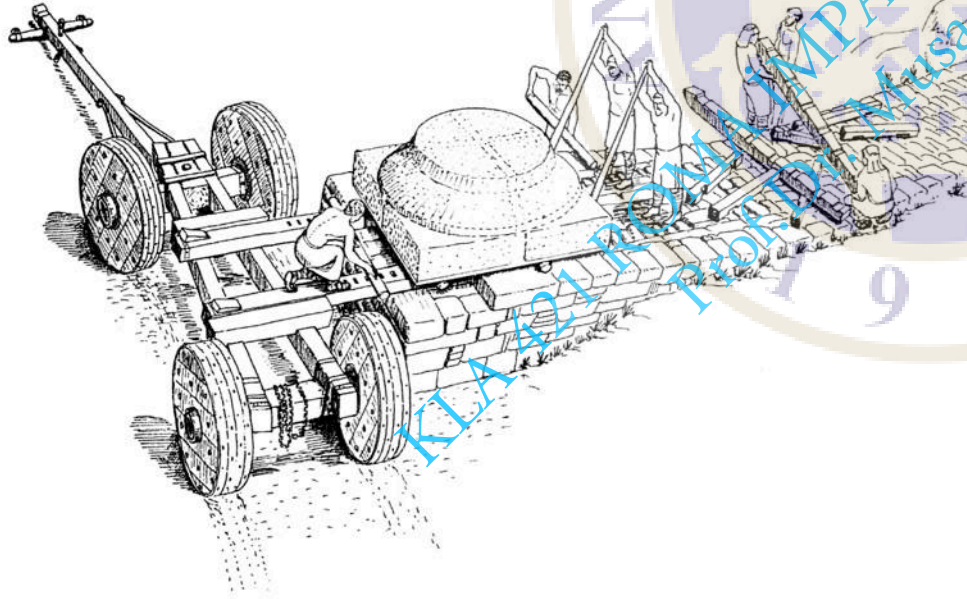

Res. 63. 4 tekerliye yarı işlenmiş bir Dor başlığının yüklenişi. Yarı işlenmiş bir başlığın ağırlığı 500 Talent, yaklaşık 12 ton, işlenmeden önceki ağırlığı ise 22 ton (Korres, Pentali, 33).

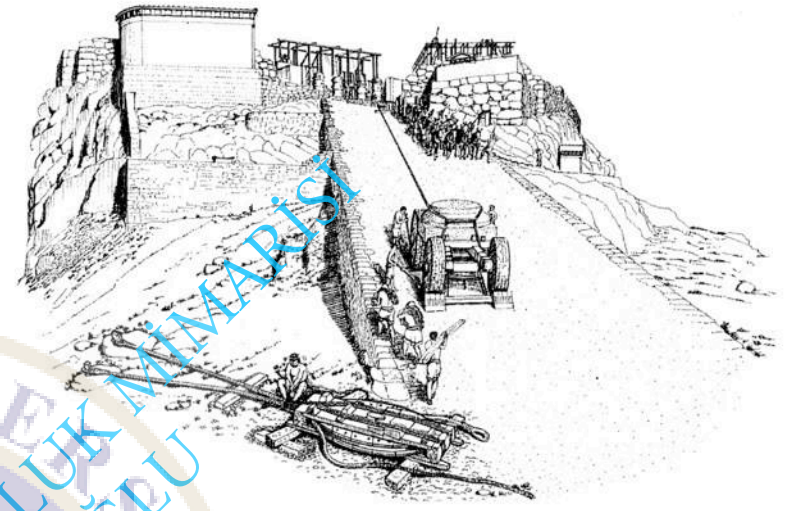

Res. 65. Aşağı inen arabanın yukarıya çıkarıldığı sistem (Korres, Pentali, 45).



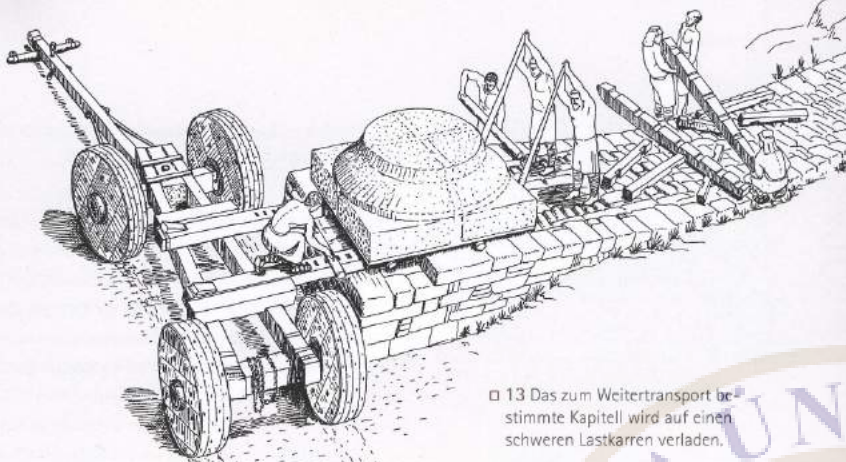

□ 13 Das zum Weitertransport bestimmte Kapitell wird auf einen schweren Lastkarren verladen.

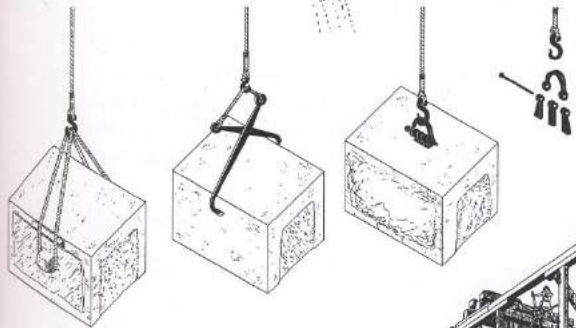
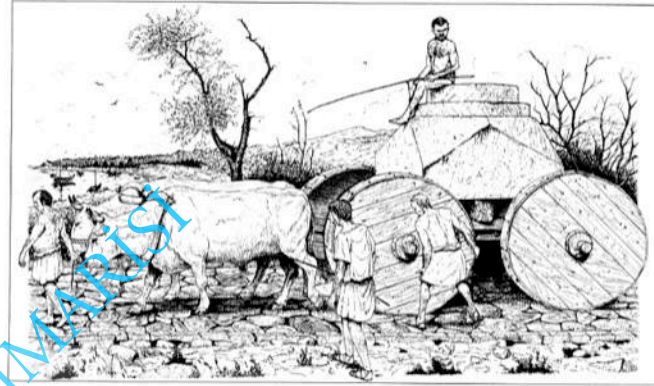

□ 14 Hebevorrichtungen

□ 15 Arbeitssituation auf einer griechischen Großbaustelle (Akropolis von Athen, Parthenon)

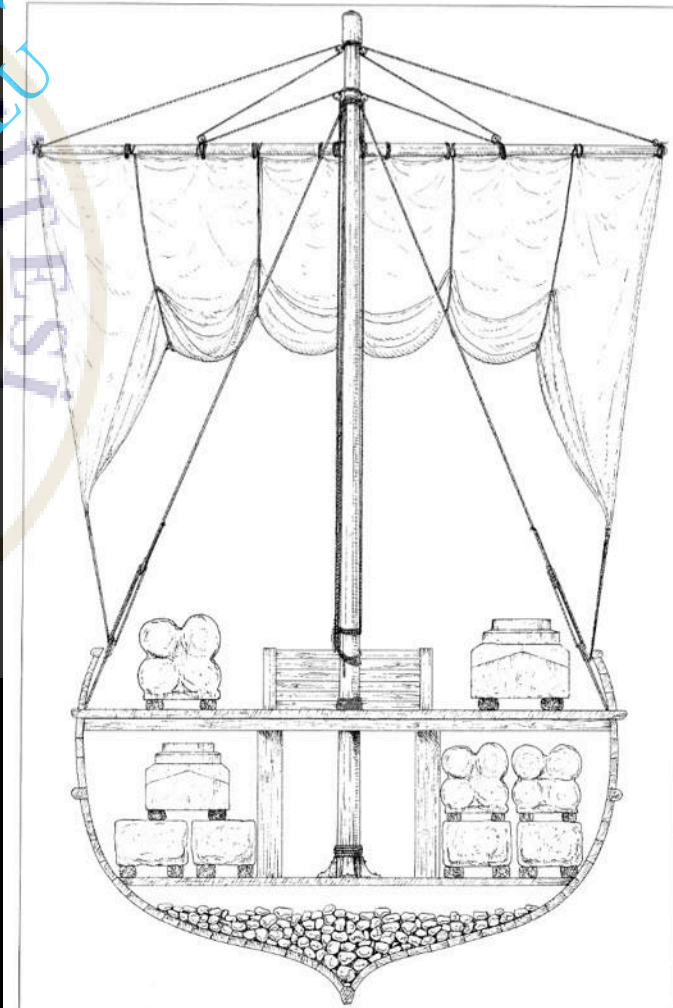
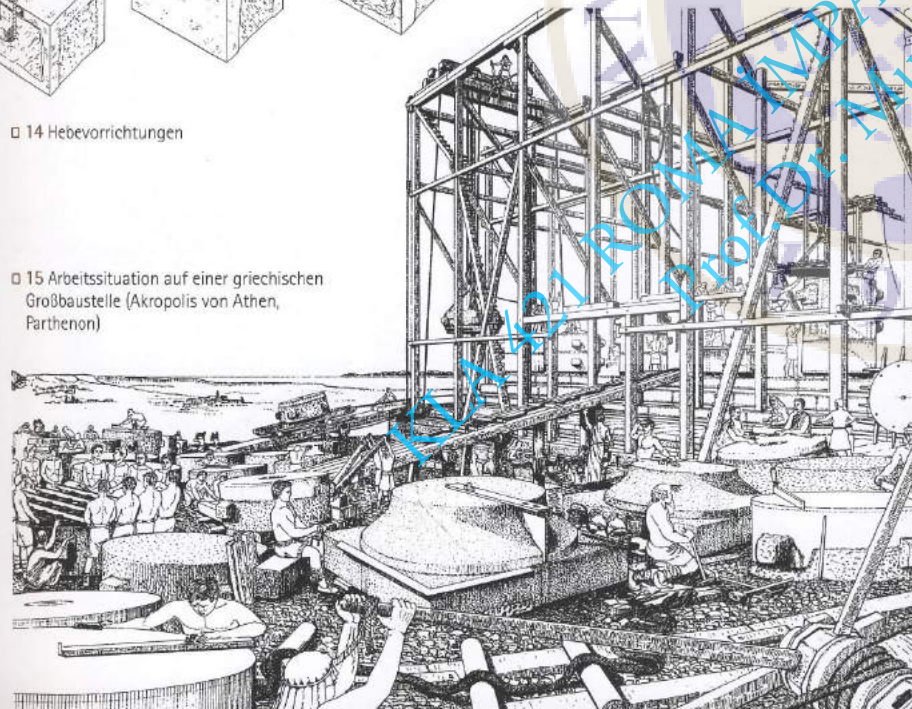

UNIVERSITÄT MIMARSI
FACULTY OF ARCHITECTURE
DR. MUSA KADIOĞLU



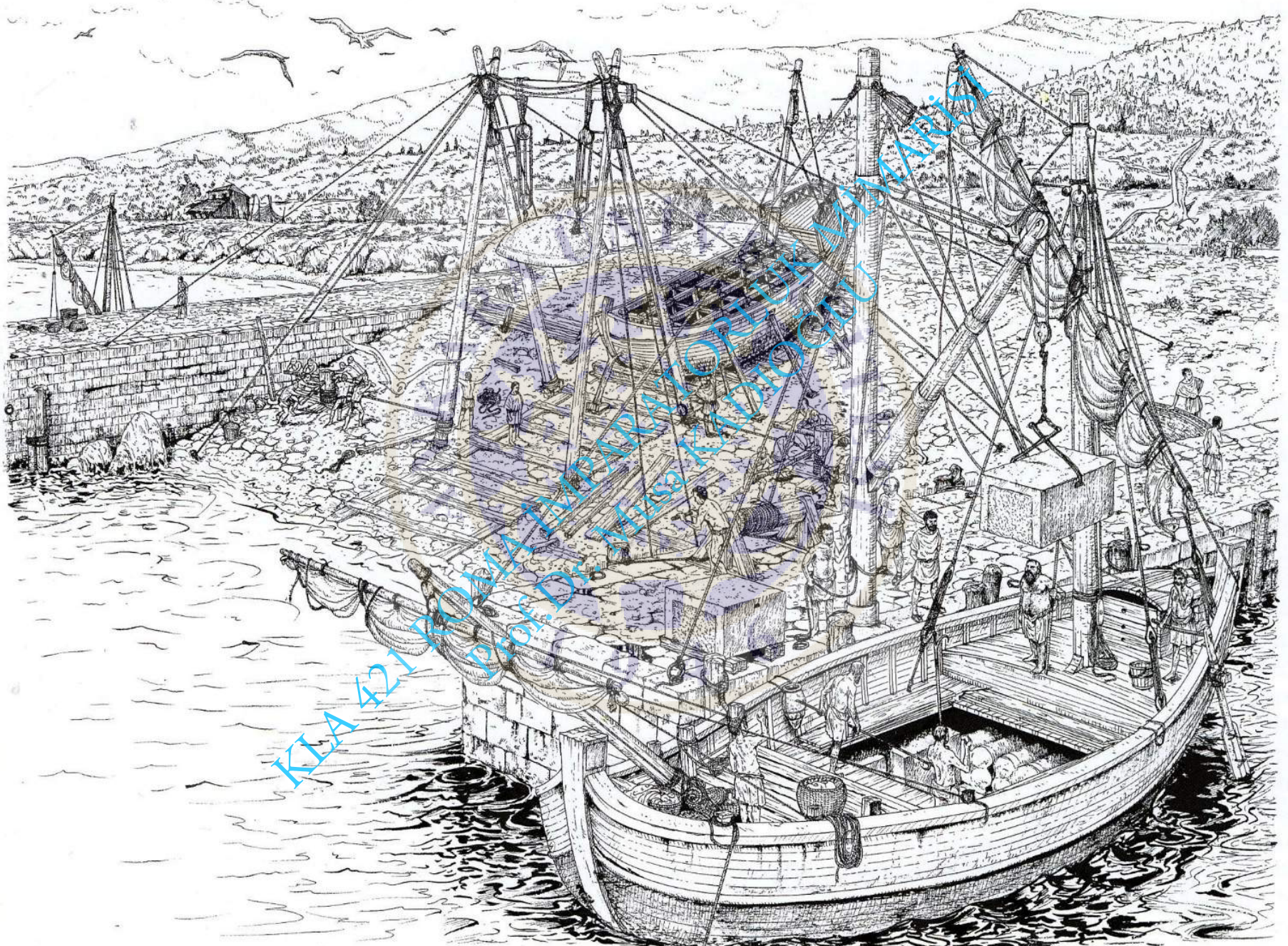

D. N. Carlson and W. Aylward, "The Kizilburun Shipwreck and the Temple of Apollo at Claros," *American Journal of Archaeology* 114.1 (2010) 145-159.



Mermer Blokların Plakalar Halinde Kesilmesi

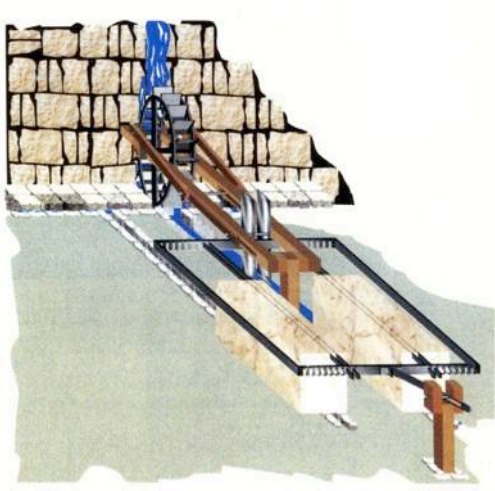

Res. 217. Katrak rekonstrüksiyonu (S. İleri, Taş Dünyası, Sept. 1998 Photo 10).



Res. 218. Leonardo Da Vinci'nin katrak çizimi (S. İleri, Taş Dünyası May/June 1998, s. 52 Fig. 7).

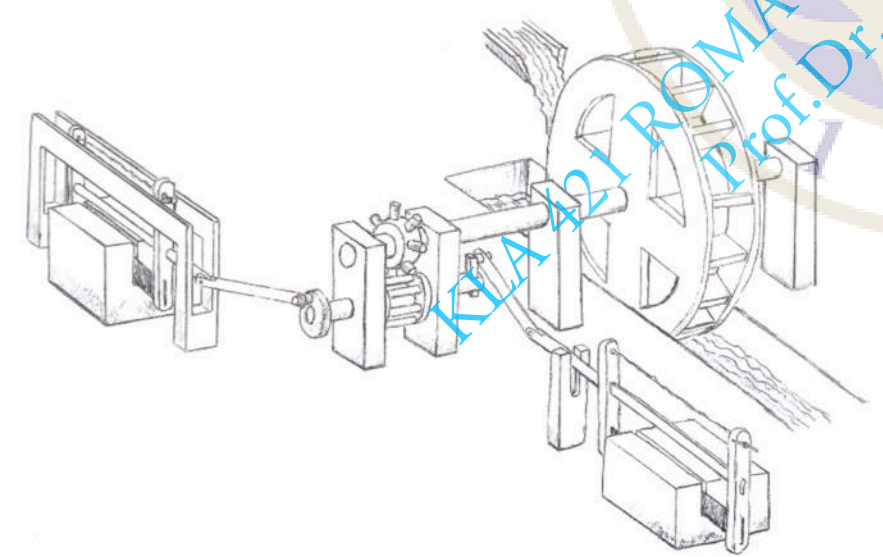

Fig. 1 The Hierapolis relief: cover of the sarcophagus of M. Aurelios Ammianos with water-powered twin stone saw and inscription (photo K. Grewe).



Fig. 2 The Hierapolis relief (detail): water wheel and chute, water from chute aiming at half height of water wheel (photo K. Grewe).

The transfer of the rotation of the waterwheel to the stone saw mechanism has been depicted schematically. The shaft of the water wheel appears to be equipped with a gear train of two gears, one wheel mounted onto the shaft of the big wheel. This wheel drives a third wheel, apparently equipped with cranks or with crank wheels (a disc of some material fixed onto the wheel shaft and equipped with a wooden metal eccentric pin), and connecting rods to convert the rotational movement of the wheel into a linear motion needed to operate the saws.



<https://www.youtube.com/watch?v=AEo9XHqeYUM>



KIA 421 ROMI IMPARATOR LUK MIMARISI
Prof. Dr. Musakadio G. U. S.



KLA 421 ROMA İMPARATORLUK MİMARİSİ
Prof. Dr. Musa KADIOĞLU



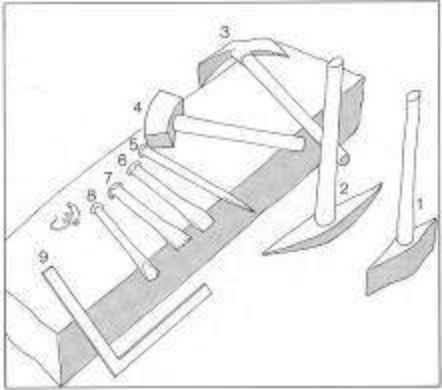

Taşçı aletleri

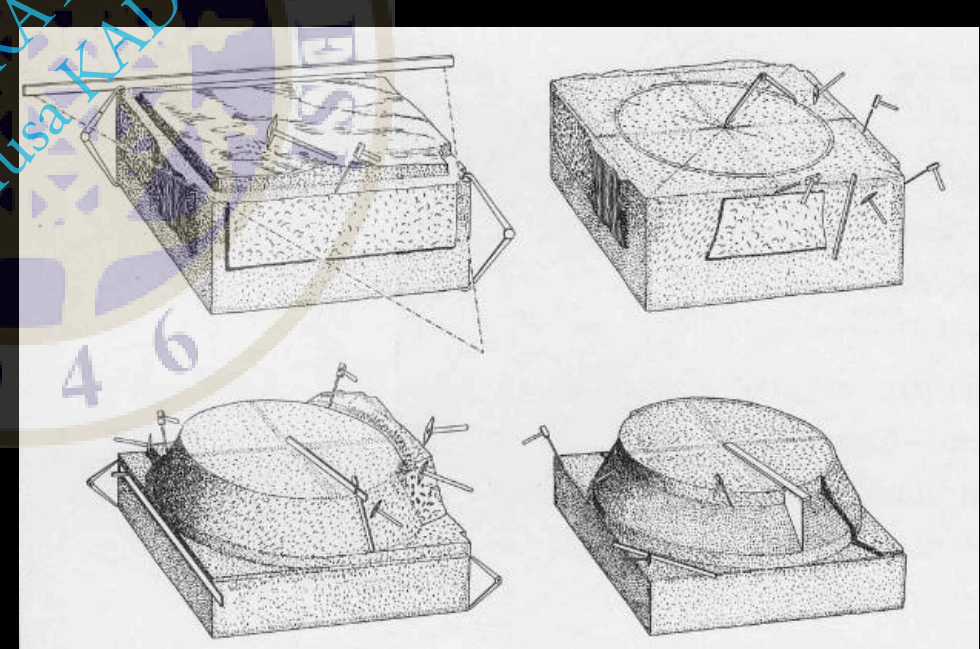

□ 11 Ein Kapitell wird in Rohform aus einem größeren Marmorquader herausgeschlagen.

Mermer blokların demir kenetlerle birleştirilme işlemi

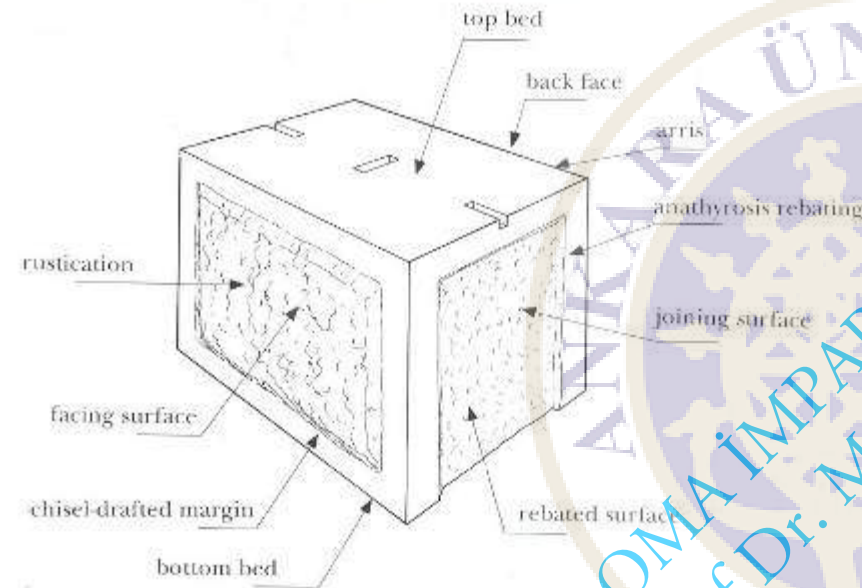

117 A number to indicate the positioning of a capital for the portico of the Temple of Venus, Pompeii.

118 Painting from the House of Sicius showing a scene on a building site. Pompeii, VIII.5, 28-57.

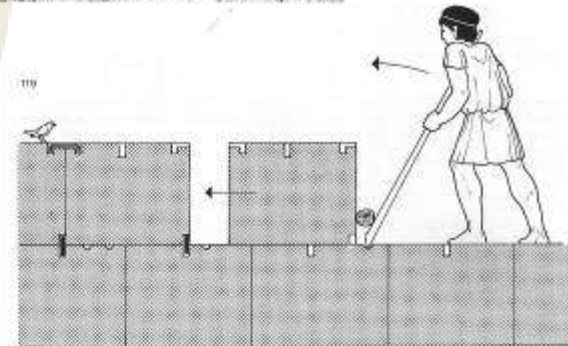

119 Wedging together blocks with a crowbar and clamping.

120 The top bed of a block from the foundations of the Roman Temple of Eurymos (Caria). Note here, from left to right, the sealing clamp, three sockets for vertical dowels (with channels for the overflow) and two spike holes, thus enabling the block to be clamped to the joint of the upper block.

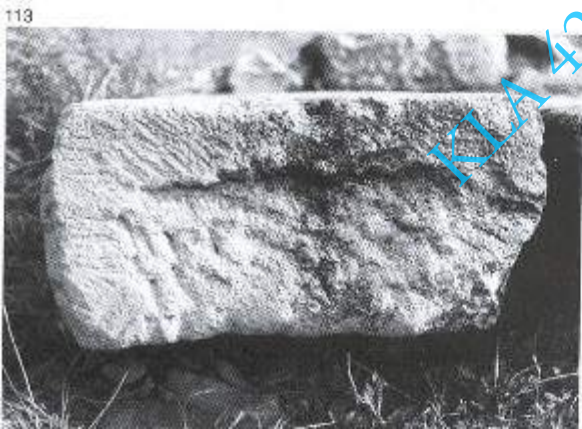

KIA 421 ROMA İMPARATORLUK MİMARİSİ
Prof. Dr. Musa KADIOĞLU

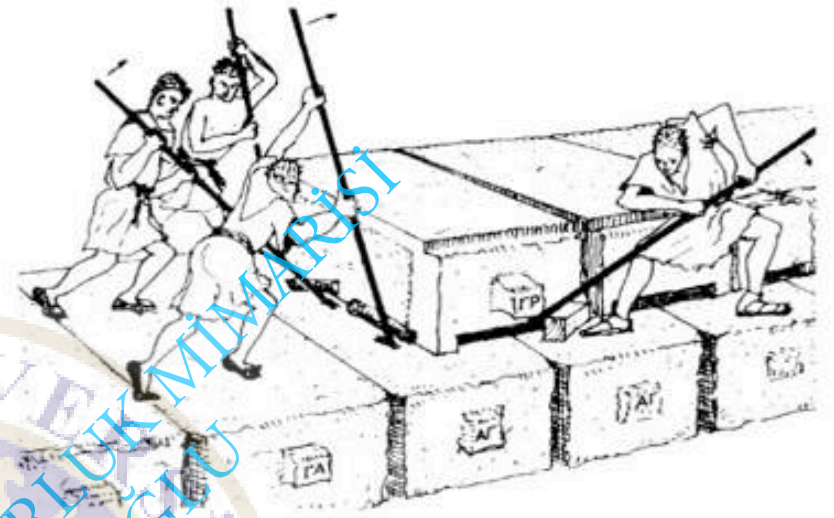
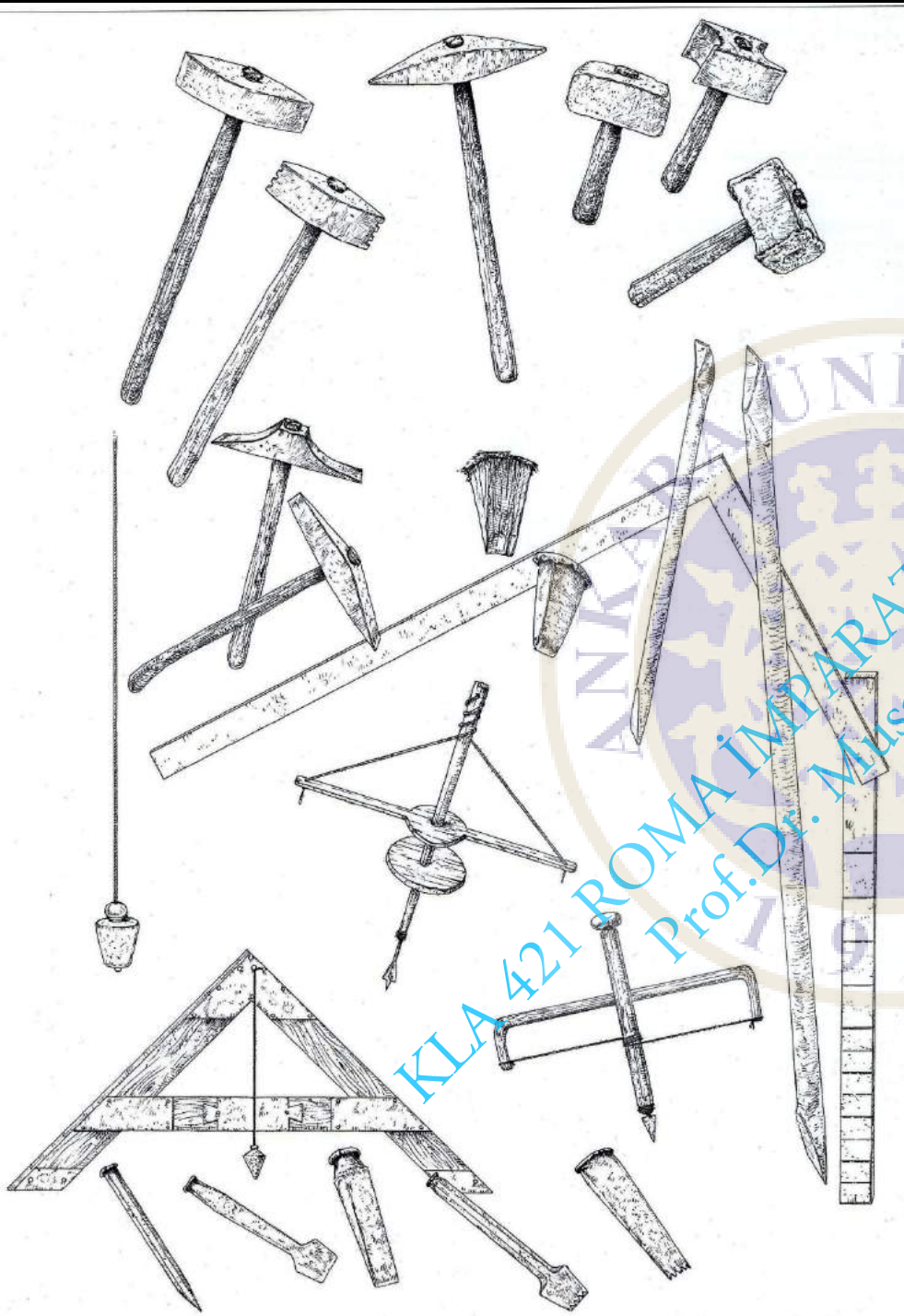

Res. 132. Küsükler yardımıyla kanırtarak yerleştirme. Oklar yerleştirme yönünü göstermektedir (Müller- Wiener. Abb. 38).

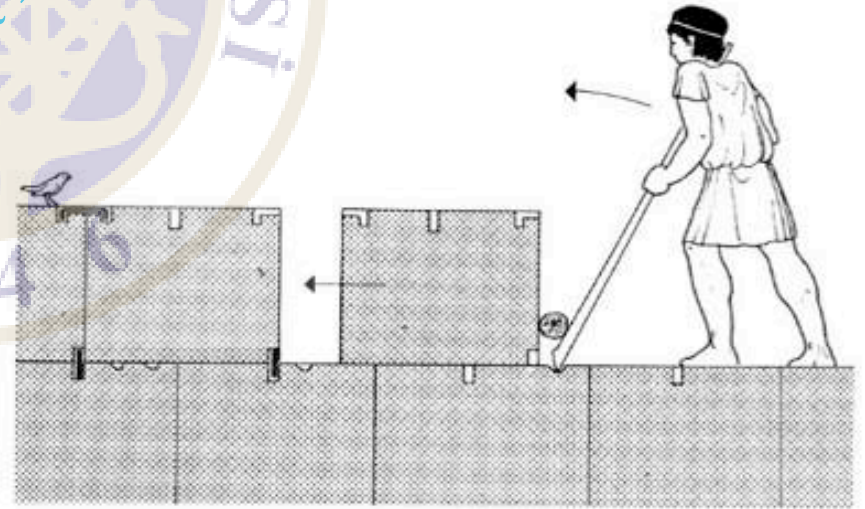

Res. 133. Taşların kanırtma deliğine sokulan küskünün öne doğru itilmesiyle ileriye doğru kaydırılmasını gösteren çizim (JPA 119).

Mimari blokların kaldırılması



ANKARA
KLA 421 ROMA İMPARATORLUK MİMARİSİ
Prof. Dr. Musa KADIOĞLU

Yüksek Kapasiteli bir vinci tasvir edildiği yüksek kabartma, Via Nomentana yolu üzerindeki Haterii Mezarı'nda

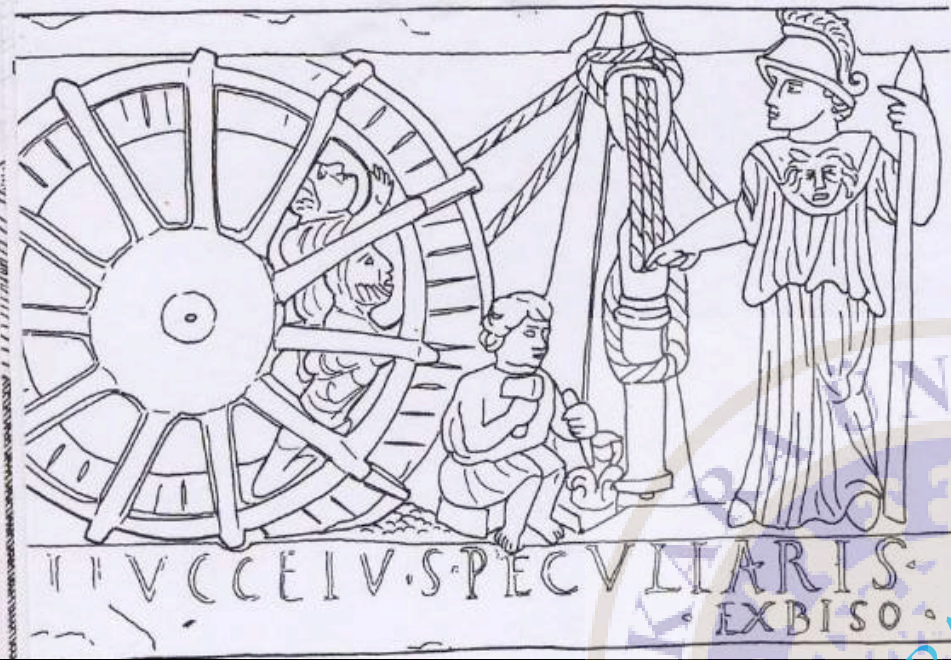

Capua'dan üzerinde bir vincin tasvir edildiği Roma Kabartması, Capua Müzesi, MS 3. yüzyıl



Bir Mimarın kontrolünde çalışan taşçıların tasvir edildiği kabartma, Ostia.





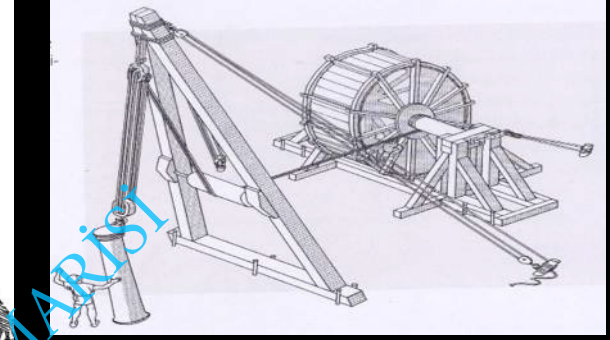
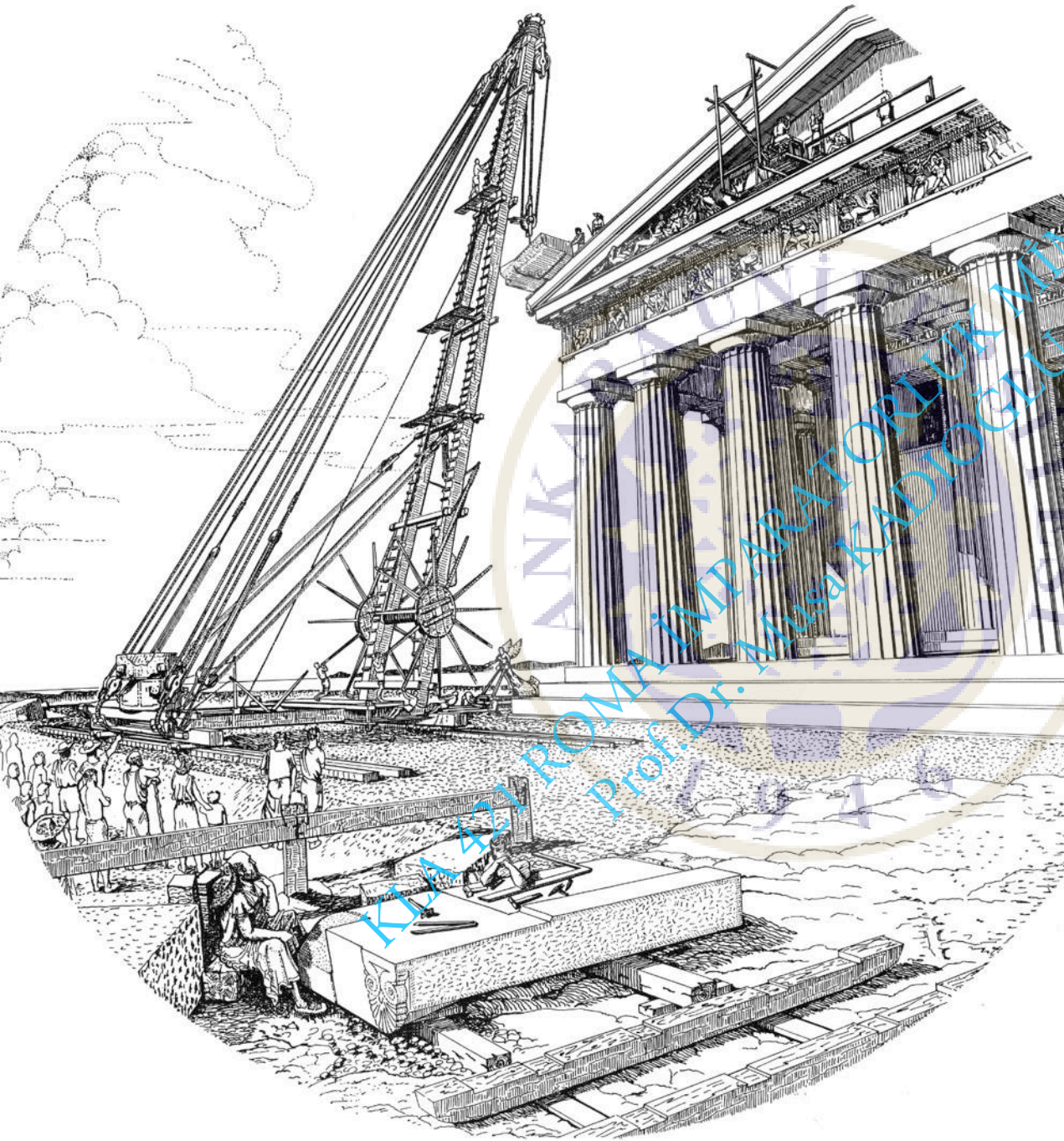

Roma Dönemi Vincinin modern restitüsyonu

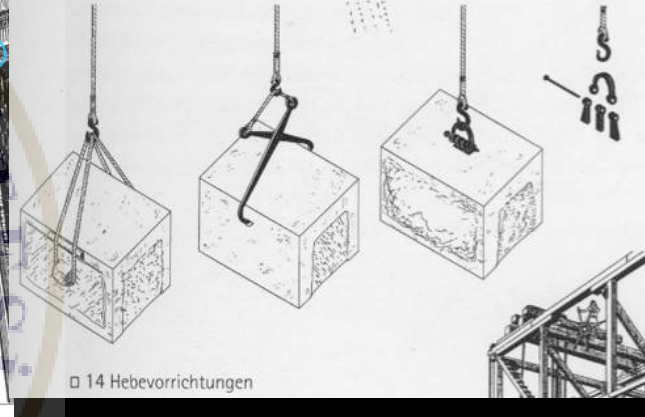

□ 14 Hebevorrichtungen

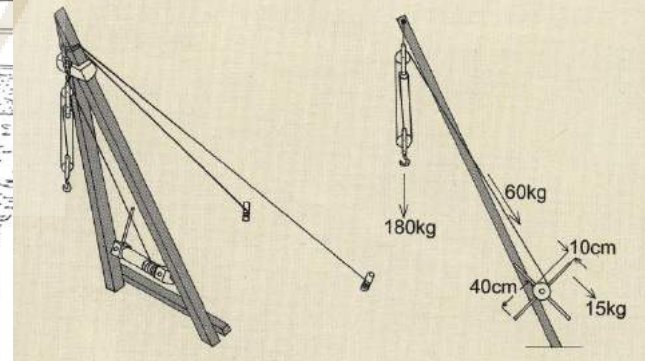

Üç Makaralı Vinç (tripastos), Ağırlık Göstergesi

Üç Makaralı Vinç (tripastos); Sağ taraftaki Ağırlık Diagramı

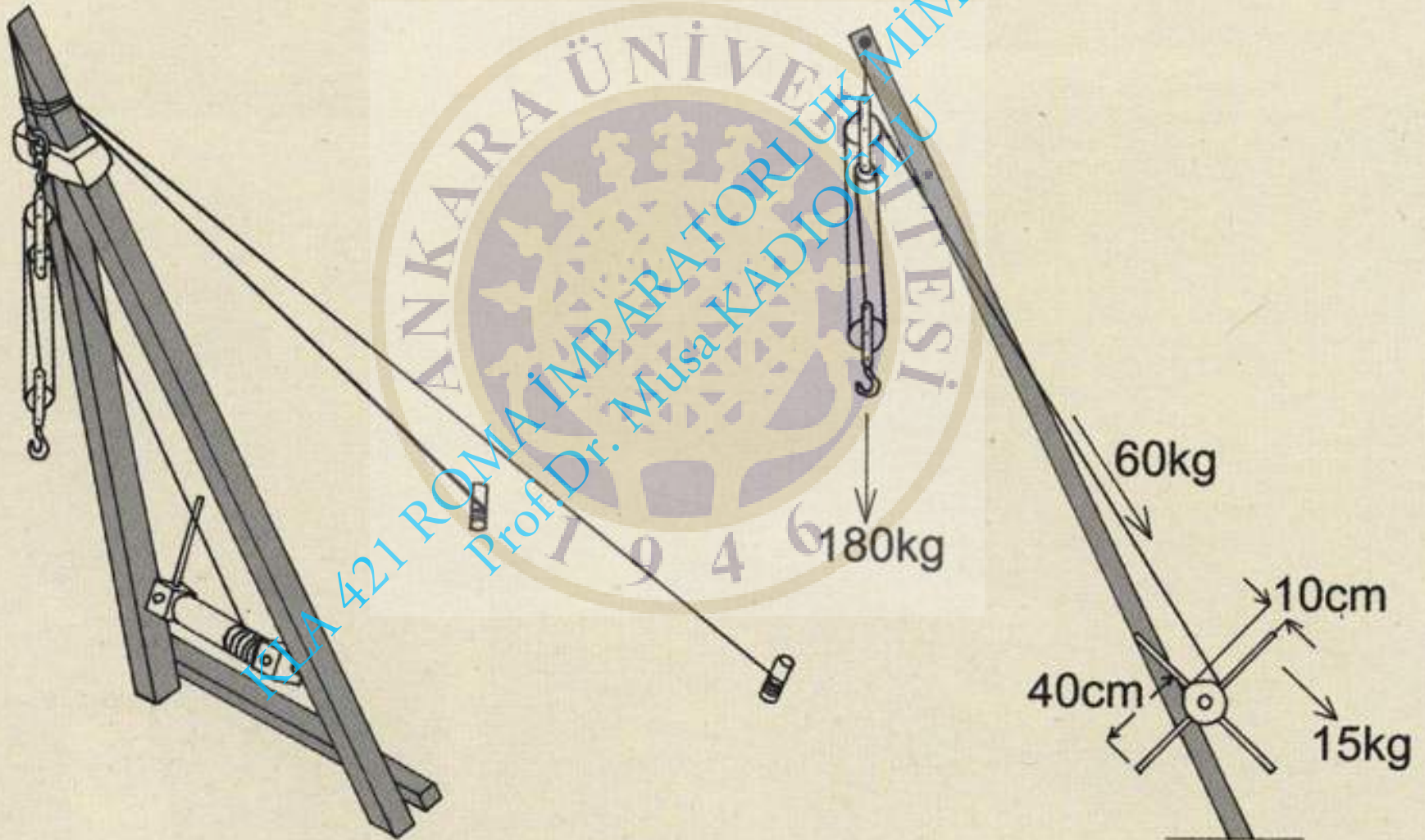

Flaschenzug aus:
Vitruv, De archi-
tectura libri X,
Como 1521.

Vitruvius'a göre palanga
sistemi

MACHINARVM TRACTORIARVM AD ONERVM ELEVATIONES-CVM
QVIBVS MOVETVR CHERITER ET EXPEDITE . FIGVRÆ 4



KLASİK ROMAN MİMARISI
Prof. Dr. Mustafa KADIOĞLU
MİMARLIK FAKÜLTESİ
MİMARLIK ANABİLİM DALI

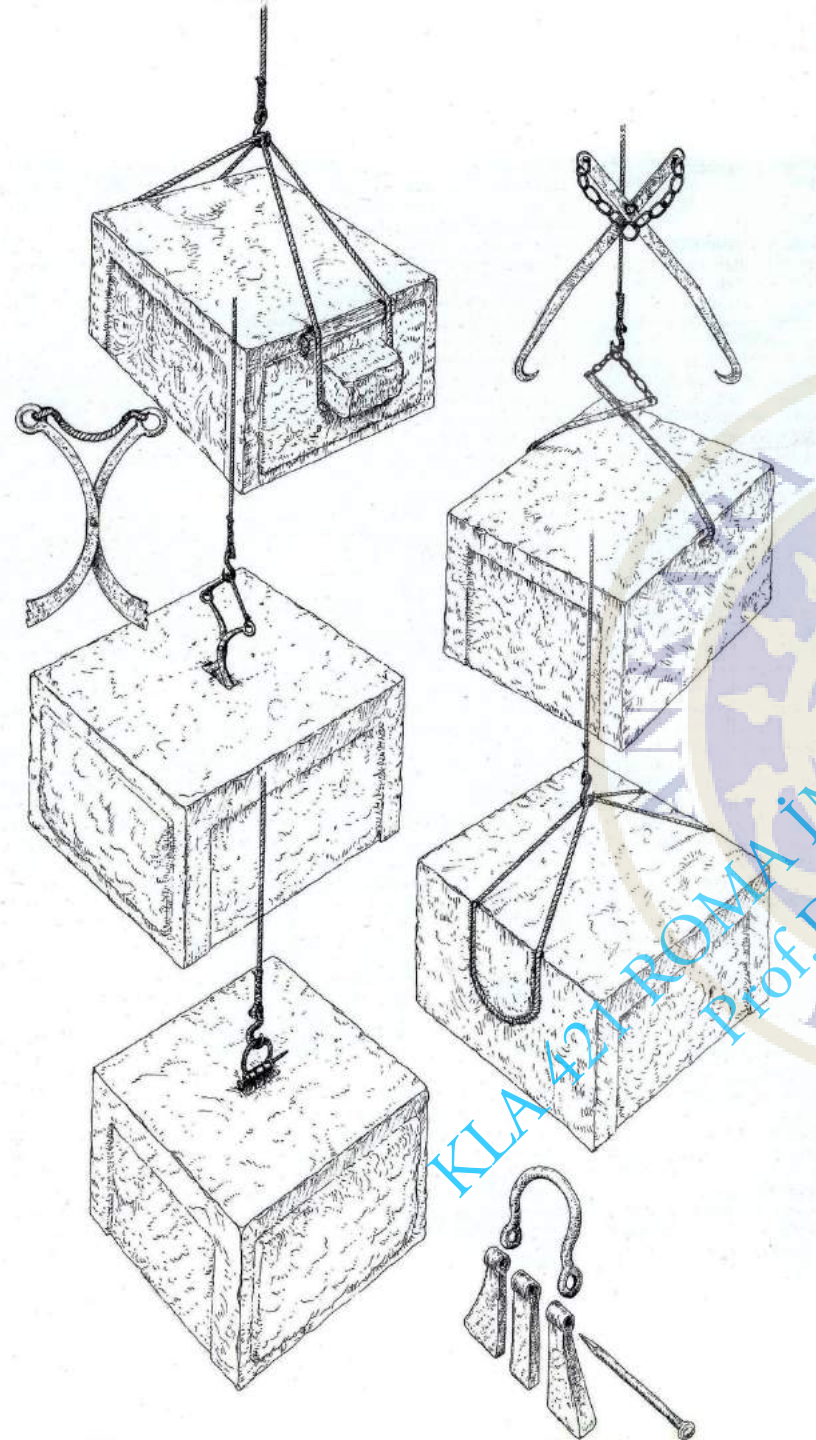

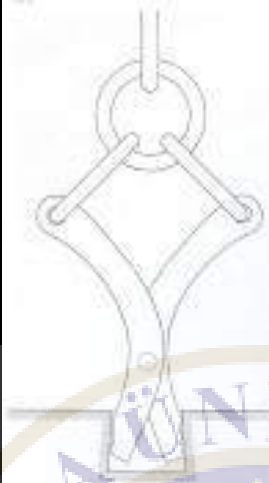
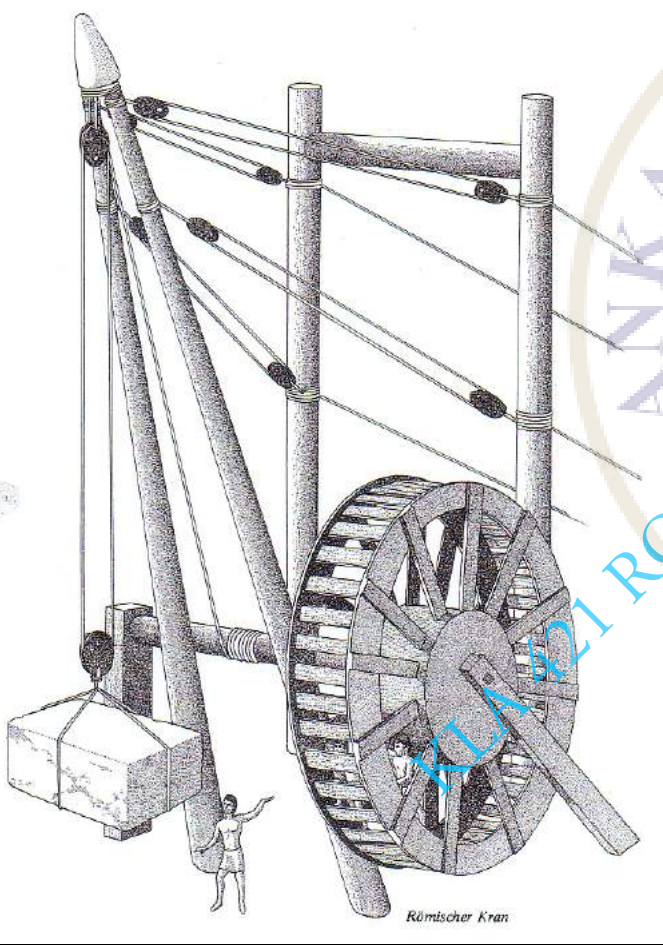

- 106 Interior grips or self-adjusting lewisas.
- 107 Grips (modern).
- 108 Holes for grips carved into a point, at the amphitheatre of El Djem.
- 109 Square holes for grips, theatre of Bulla Regia.
- 110 Summary of the different lifting methods in Roman architecture: brasses, grips, lewis.



points of the self-adjusting pincers grip in small holes made symmetrically in the two vertical surfaces. When the grips are used on the joining surfaces (the pediment monument at Glanum, for instance), the process remains invisible and so is superior to the use of the lewis as it is much quicker. However, when the holes are cut into the front and back faces of a block, the numerous marks are visible on the facing (Porta Maggiore, amphitheatre of El Djem, theatre at Bulla Regia).

require an exact size of hole to be cut (fig.106).
 With the use of grips or iron forceps (*ferrei forcipes*) the preparatory work is even further reduced; all that is necessary is to make sure that the two hooked

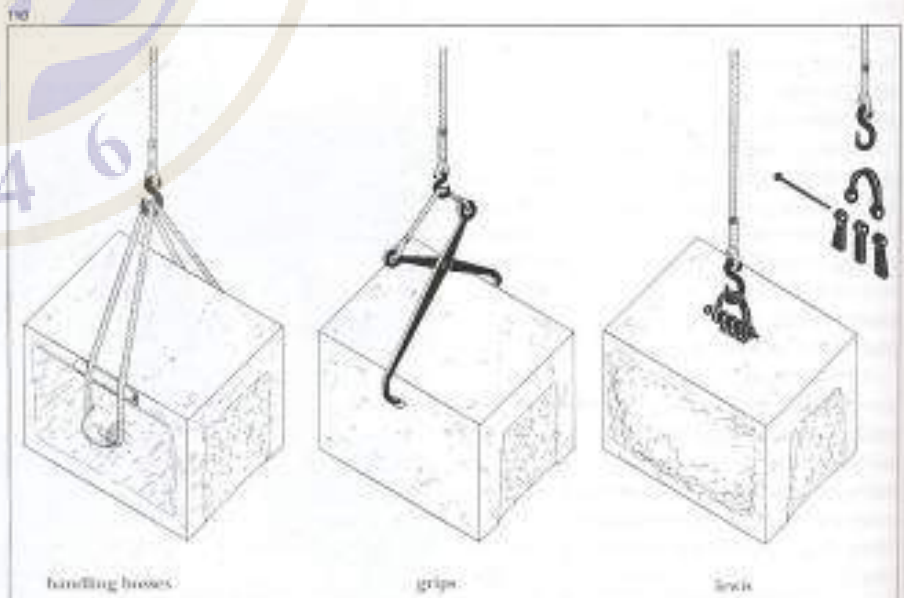

UNIVERSITÀ ROMA IMPERATORIA MUSEO MAMMARIANI
 Prof. Dr. Musa KADIOĞLU MAMARISI

Luni, Carrara, Toscana

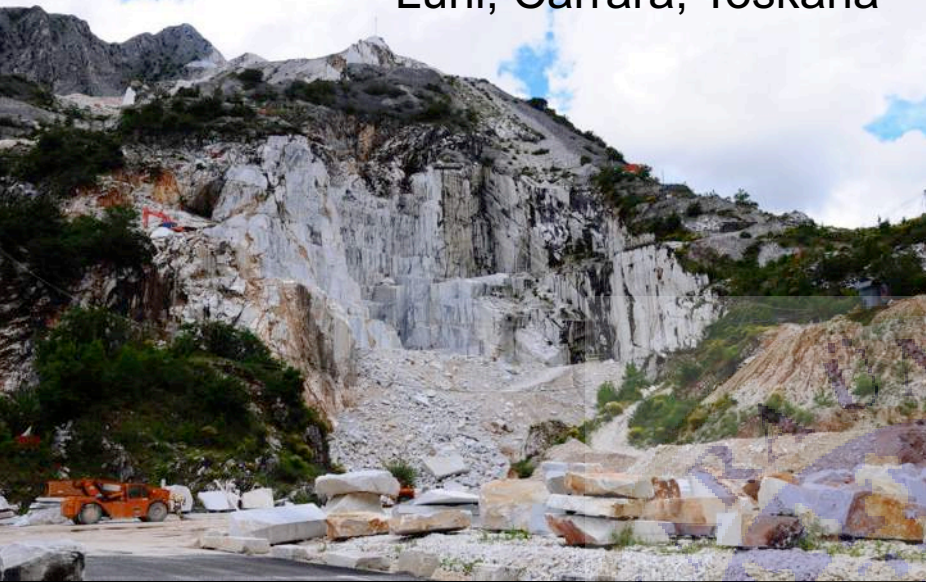

Luni, Carrara, Toscana

Muğla, Yatağan



Luni, Carrara, Toscana





2. Dislocazione delle principali cave di marmo bianco in Asia Minore (contrassegnate da un triangolo nero) in relazione alle principali città e alle vie di trasporto fluviale interno (da Pensabene 1978)

KIA 421 ROMA IMPERATORLUK MIMARISI
Prof. Dr. Musa KADIOĞLU

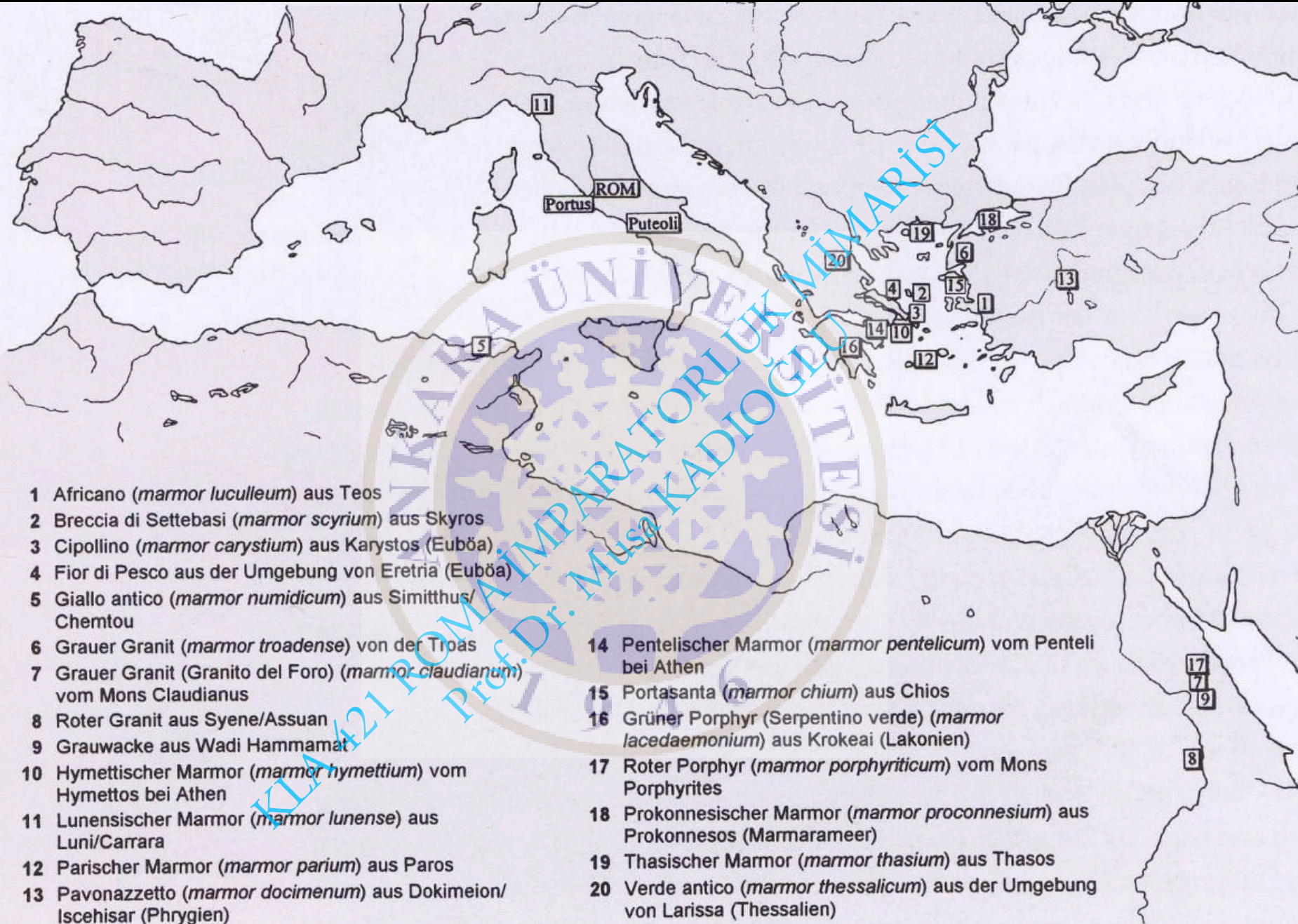

- | | |
|---|--|
| 1 Africano (<i>marmor luculleum</i>) aus Teos | 14 Pentelischer Marmor (<i>marmor pentelicum</i>) vom Penteli bei Athen |
| 2 Breccia di Settebasi (<i>marmor scyrium</i>) aus Skyros | 15 Portasanta (<i>marmor chium</i>) aus Chios |
| 3 Cipollino (<i>marmor carystium</i>) aus Karystos (Euböa) | 16 Grüner Porphy (Serpentino verde) (<i>marmor lacedaemonium</i>) aus Krokeai (Lakonien) |
| 4 Fior di Pesco aus der Umgebung von Eretria (Euböa) | 17 Roter Porphy (<i>marmor porphyriticum</i>) vom Mons Porphyrites |
| 5 Giallo antico (<i>marmor numidicum</i>) aus Simitthus/Chemtou | 18 Prokonnesischer Marmor (<i>marmor proconnesium</i>) aus Prokonnesos (Marmarameer) |
| 6 Grauer Granit (<i>marmor troadense</i>) von der Troas | 19 Thasischer Marmor (<i>marmor thasium</i>) aus Thasos |
| 7 Grauer Granit (Granito del Foro) (<i>marmor claudianum</i>) vom Mons Claudianus | 20 Verde antico (<i>marmor thessalicum</i>) aus der Umgebung von Larissa (Thessalien) |
| 8 Roter Granit aus Syene/Assuan | |
| 9 Grauwacke aus Wadi Hammamat | |
| 10 Hymettischer Marmor (<i>marmor hymettium</i>) vom Hymettos bei Athen | |
| 11 Lunensischer Marmor (<i>marmor lunense</i>) aus Luni/Carrara | |
| 12 Parischer Marmor (<i>marmor parium</i>) aus Paros | |
| 13 Pavonazzetto (<i>marmor docimenum</i>) aus Dokimeion/Ischisar (Phrygien) | |

□ 7 Karte mit den wichtigsten überregionalen Marmorvorkommen

İmparator Diocletian Fiyat Tarifesi (MS 301)

Kimsenin yükseltmeyeceği birbirinden ayrı işlemlerin (kalemlerin) ücretleri aşağıda listelenmiştir.

İŞGÜCÜ ÜCRETLERİ

Denarii

Eğitim Gerektiren/Profesyonel İşçi Ücretleri

Yazıcı (en iyi kalite yazı için)	100 satır	25
Yazıcı (ikinci derece kalite yazı için)	100 satır	20
(Tabellio) Kamu yazıcısı (resmi dilekçe ya da tablet)	100 satır	-
Noter	dilekçe veya yasal belge başına	10
Avukat veya hukukçu (in postulatione)	şikayet başına	250
Avukat ya da hukukçu (in cognitione)	dava açma ücreti	1000

Asker Ücretleri

Ortalama asker maaşı	yıllık	1800
Saray muhafızı (Praetorian)	yıllık	5500
(Askere) Tahıl ödeneği	yıllık	600
(Askere) İkramiye	dört yılda bir	2500

Öğretmen Ücretleri

Her bir bilim adamı için ...	aylık	50
Her bir öğretmene	erkek öğrenci başına	50
Okuma yazma öğretmeni	erkek öğrenci başına	50
Yazı öğretmeni	erkek öğrenci başına	75
(Calculator) Aritmetik öğretmeni	erkek öğrenci başına	75
Grekçe, Latince, Geometri öğretmeni	öğrenci başına	200
Retorik ve Güzel Konuşma öğretmeni	öğrenci başına	250
Mimarlık öğretmeni	erkek öğrenci başına	100
Kütüphaneci	öğrenci başına	50

Vasıflı İşçi /Zanaatkar Ücretleri

Duvarcı (yemek dahil)	günlük	50
Mermer işçisi (yemek dahil)	günlük	60
Mozaik işçisi (yemek dahil)	günlük	60
Duvar boyacısı	günlük	75
Siva işçisi	günlük	50
Desen yapıcı (ressam işçi)	günlük	150
Arabacı	günlük	50
Demirci	günlük	50
Fırıncı	günlük	50
Denize açılan gemilerde çalışan tersane işçisi	günlük	60

Gümüş parlatma tozu	yakl. 453 gr.	10
Tutkal (balıktan elde edilen (?))	yakl. 453 gr.	80
Tutkal (boğadan elde edilen (?))	yakl. 453 gr.	20
Tutkal (?)	yakl. 453 gr.	10

Mermer Ücretleri

Porfir	yakl. 37 cm.	-
Lakedaimonia	yakl. 37 cm.	-
Luculla	yakl. 37 cm.	150 --
Claudia	yakl. 37 cm.	100 --
Docimian	yakl. 37 cm.	200 --
Anacastane	yakl. 37 cm.	-
Thesselia	yakl. 37 cm.	150 --
Scyrian	yakl. 37 cm.	40 --
Lesbos	yakl. 37 cm.	50
Phasos	yakl. 37 cm.	-
Potamogallene (?)	yakl. 37 cm.	-

Kılık-kıyafet/Ayakkabı Ücretleri

(Birrus) Birinci kalite yünden elbise kılıfı	1 adet	-
İkinci kalite yünden elbise kılıfı	1 adet	40
(Caracallis) Topuklara kadar uzanan başlıklı manto	1 adet	20
Başlıksız kısa manto	1 adet	20
(Braces) Pantolon	1 adet	20
(Udones) Çorap	1 çift	4
(Sarcinator) Terziye iç gömlek astar kaplama	-	6
Terziye ipekten elbise süslemesi yaptırılması	-	50
Terziye, içi keten ve ipek gibi farklı maddelerle doldurulmuş nesnelere süsleme diktirilmesi	-	30
Kaba iç gömleği süslemesi	-	4
Süslemesiz kadın tuniği	1 adet	16
İkinci el kadın tuniği	1 adet	10
Kadın iç gömleği ya da bluzu	1 adet	10
İkinci el kadın iç gömleği ya da bluzu	1 adet	6
Süslemesiz pelerin	1 adet	16
İkinci el pelerin	1 adet	6
Afrika mantosu	1 adet	500
Dalmaçya tuniği	1 adet	2000
Laodikya'dan başlıklı manto	1 adet	4500
Tarentum yünü	-	75
Beyaz ipek	-	12000

Dokimeion



Simitthus/Chemtou:
Giallo Antico

Karystos

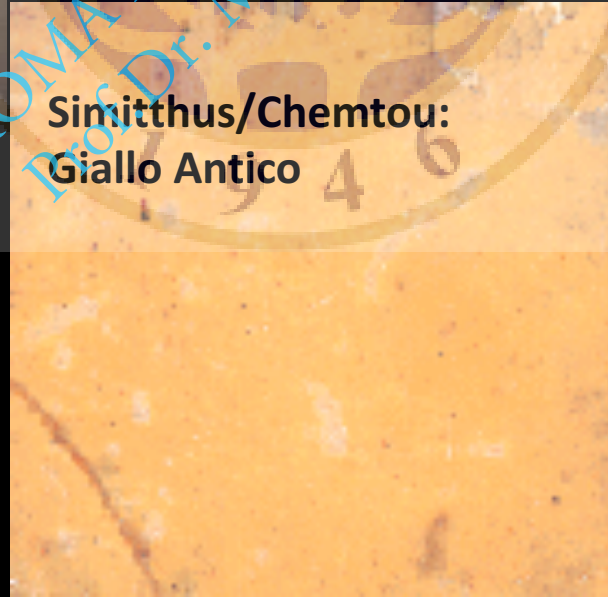



ANKARA ÜNİVERSİTESİ
MİMARLIK FAKÜLTESİ
Prof. Dr. Musa KADIOĞLU
KLA 421 ROMA İMPARATORLUK MİMARİSİ



Fig. 1 The optimal reconstruction of the Odeion's *Scenae Frons* (computer model rendering)



<https://www.youtube.com/watch?v=UxGAZxvvquM>