

# Kimyasal Sensörler

- Sensör yüzeyi kimyası ve transdüser yüzeyi

## Sensör Yüzeyi Kimyası ve Transdüser Yüzeyi

Tiyol.....  
 Maleimide.....  
 Aldehit.....  
 Epoxy.....  
 Kompleks.....  
 Streptavidin.....  
 Transdüser  
 (Elektrot)

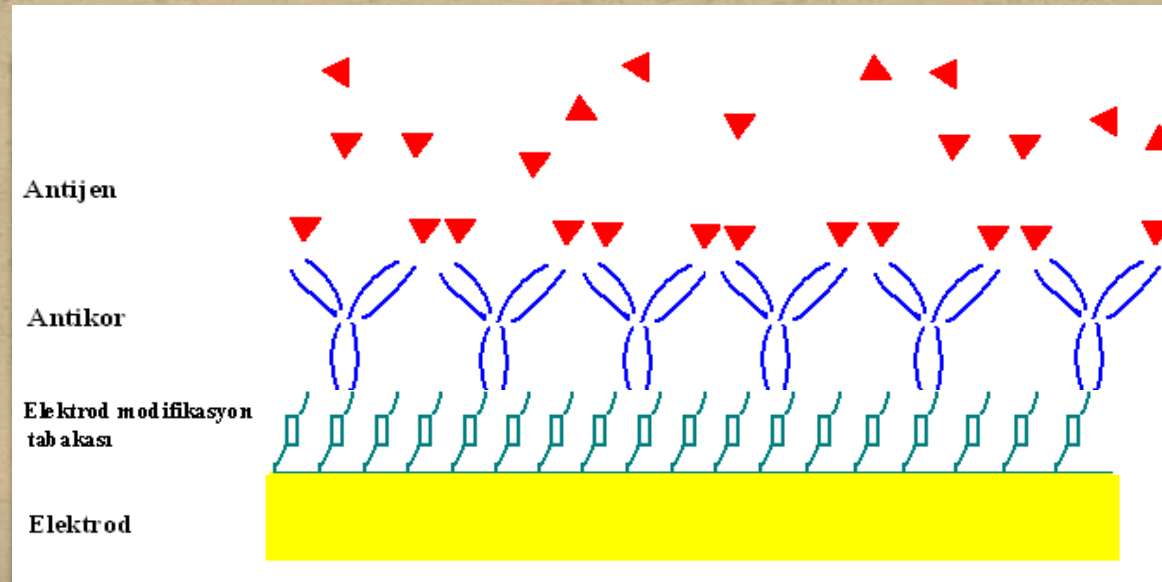
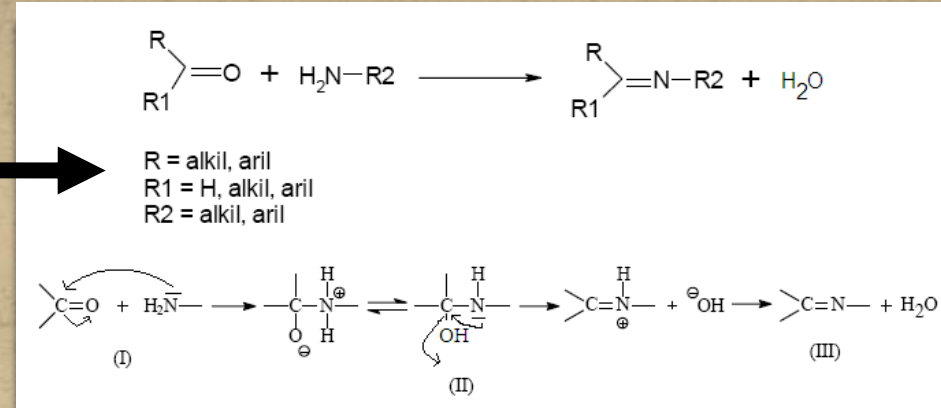
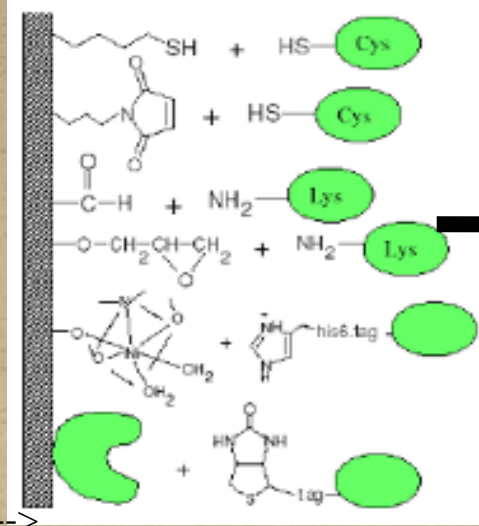

Elektrot yüzeyi seçimli olarak antikor veya antijen ile hazırlanabilir

# Antijen-Antikor etkileşmesi

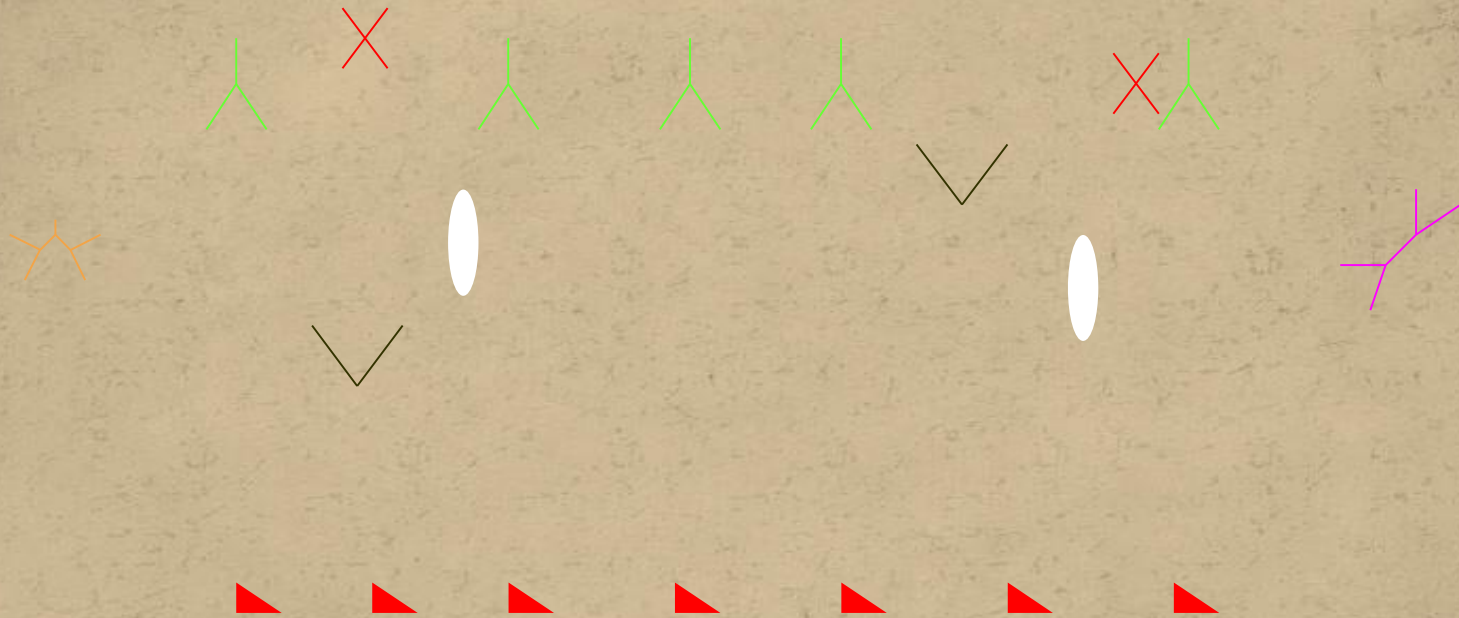

**Elektrot**

Elektrot yüzeyi seçimli olarak antikor veya antijen ile hazırlanabilir

# Aminlenmiş-Polivinil klorür (PVC-NH<sub>2</sub>) sentezi

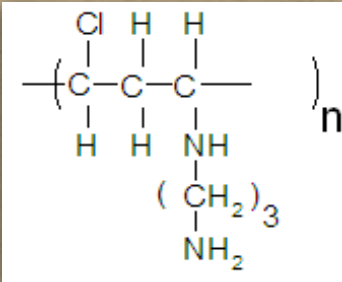

● Element analizi: C, % 39.04; H, % 6.080; N, % 9.97

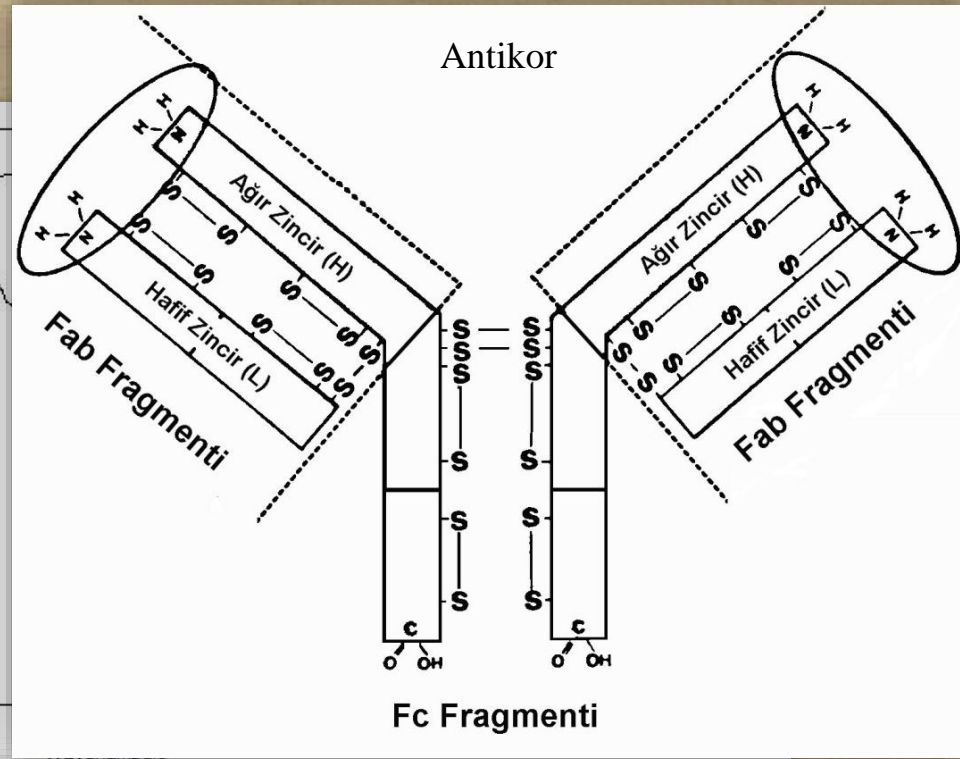
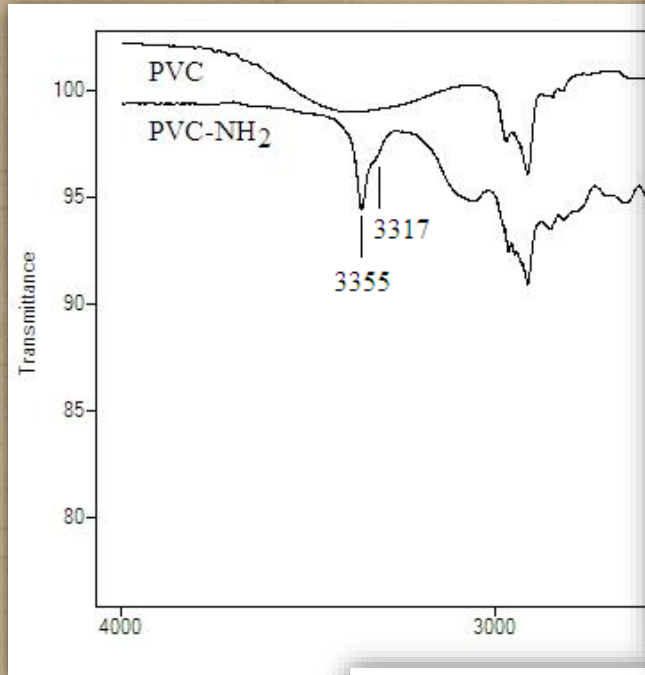

■ 3355, 3317 cm<sup>-1</sup>; -NH<sub>2</sub>

■ 1629 cm<sup>-1</sup>; R-C=N-

Elektrod modifikasyon tabakası

Elektrod



# PVC-NH<sub>2</sub> kaplı kristal yüzeyi – SEM ve FTIR-ATR

Fiksatif – Aminlenmiş PVC

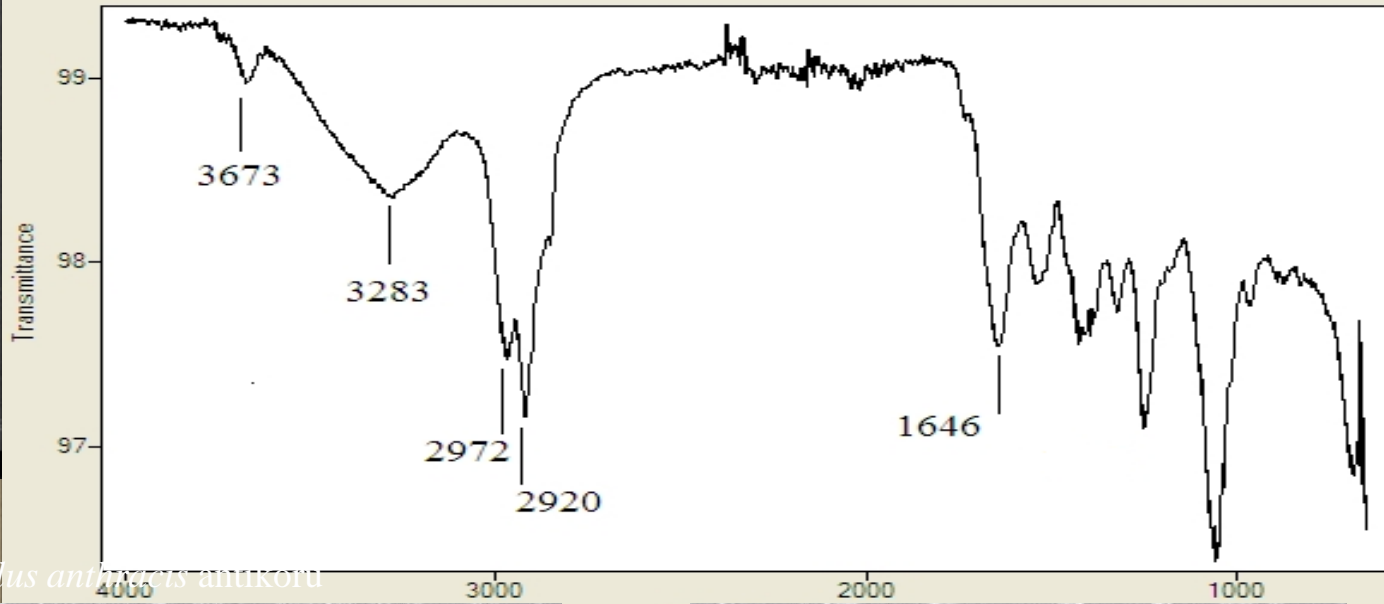

*Bacillus anthracis* antikorları

- 3
- -NH
- 3
- 2
- 1

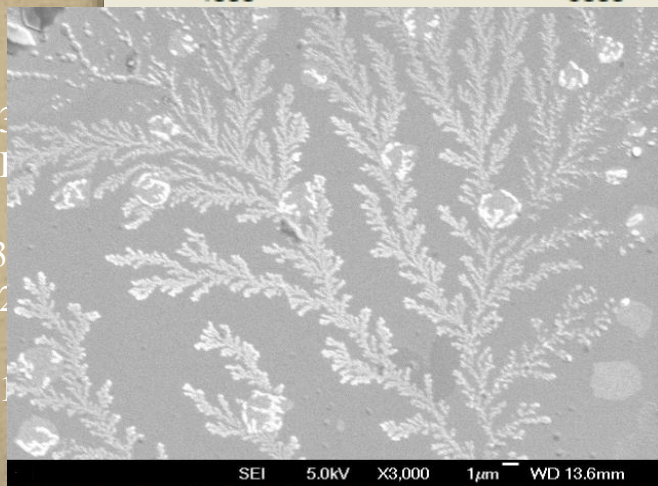

3000x

■ i ; hidro  
■ i ; inter/i  
■ gerilme  
■ - konjug

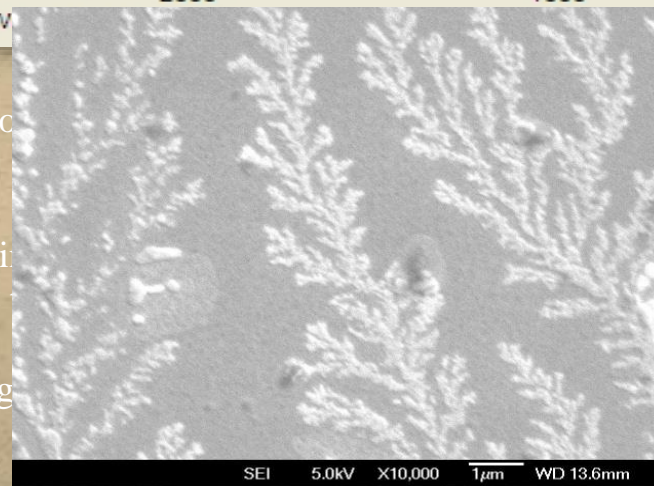

10000x

grupları

# Örnek: antikor - antijen etkileşmesi

Akrep

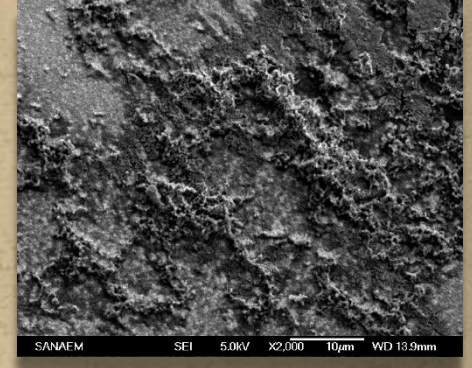
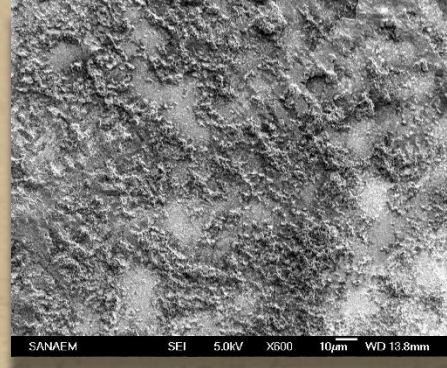
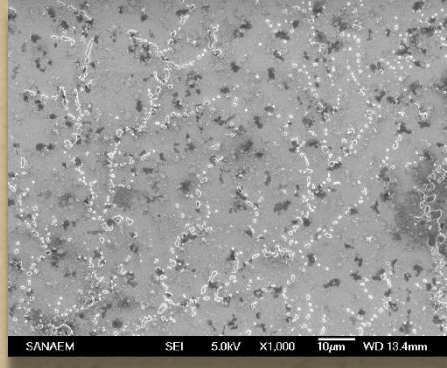
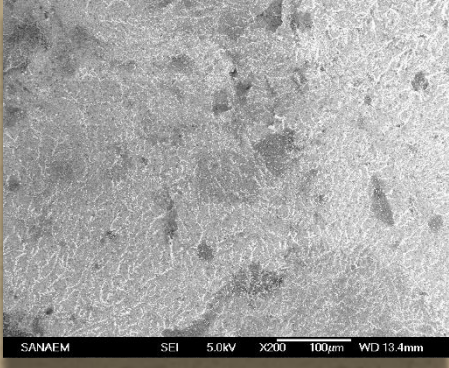

Antikor

Antikor-Antijen



ELSEVIER

Available online at [www.sciencedirect.com](http://www.sciencedirect.com)

SCIENCE @ DIRECT®

Prog. Polym. Sci. 29 (2004) 699–766

---

---

PROGRESS IN  
POLYMER SCIENCE

---

---

[www.elsevier.com/locate/ppolysci](http://www.elsevier.com/locate/ppolysci)

## Polymers in sensor applications

Basudam Adhikari\*, Sarmishtha Majumdar

*Materials Science Centre, Indian Institute of Technology, Kharagpur 721302, India*

Received 11 December 2002; revised 15 March 2004; accepted 16 March 2004

Available online 19 May 2004